

SCREEN YOUR TELEPHONE CALLS ELECTRONICALLY!

# Radio Electronics

DECEMBER 1990

TECHNOLOGY - VIDEO - STEREO - COMPUTERS - SERVICE

## BUILD THIS BENCHTOP FREQUENCY COUNTER

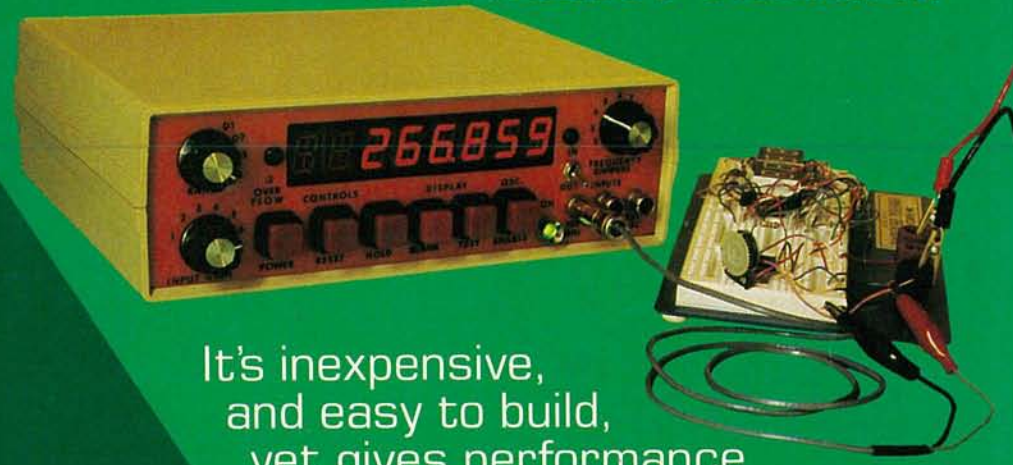

It's inexpensive,  
and easy to build,  
yet gives performance  
over 1GHz

## DIGITAL CIRCUIT SIMULATION USING SUSIE

Are breadboards  
becoming a thing  
of the past?

## CHOOSING THE RIGHT TEST PROBE

The right probe can  
really make a  
difference

## BUILD THIS HI-TECH CHRISTMAS CARD

Frequency-selective  
filters help create a  
spectacular display

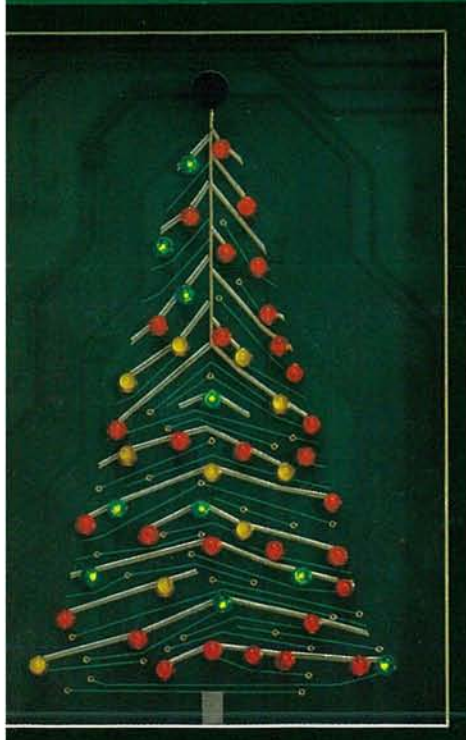

\$2.95 U.S.  
\$3.75 CAN

A  
**GERNSBACK**  
PUBLICATION





**FLUKE**®



**PHILIPS**

**FLUKE 73**

\$79\*  
Analog/Digital display  
Volts, ohms, 10A (fused), diode test  
0.7% basic dc accuracy  
2000+ hour battery life  
3-year warranty

**FLUKE 75**

\$119\*  
Analog/Digital display  
Volts, ohms, 10A & mA (both fused), diode test  
0.5% basic dc accuracy  
Audible continuity  
Autorange/range hold  
2000+ hour battery life  
3-year warranty

**FLUKE 77**

\$159\*  
Analog/Digital display  
Volts, ohms, 10A & mA (both fused), diode test  
0.3% basic dc accuracy  
Touch Hold®  
Audible continuity  
Autorange/range hold  
2000+ hour battery life  
Multipurpose holster  
3-year warranty

\*Suggested U.S. list price



# Simply the Best.

**More than two million users agree:** the Fluke 70 Series handheld digital multimeters are simply the best.

These originals have become classics. And the reasons are simple.

They are accurate and easy to use. Features made popular by the 70 Series—like fast autoranging, continuity beeper, and quick diode test—are now standards in the industry.

Other 70 Series features stand alone. Touch Hold®, for example, locks the reading on the display and signals you with a beep. So

you can keep your eyes on the circuit and probes.

The 70 Series are built without compromise. All current ranges are fully fused. The resistance function is overload protected to 500V. No detail has been overlooked in making these rugged and reliable meters the first choice of two million professionals.

Made in the USA using state-of-the-art manufacturing methods, every Fluke 70 Series multimeter is backed by a 3-year warranty. Another first in the industry.

Choosing the best handheld multimeter is very simple. Pick up the Fluke 70 Series at your Fluke distributor today. Or call **1-800-44-FLUKE, ext 33**, for a free brochure.

John Fluke Mfg. Co., Inc. P.O. Box 9090, Everett, WA 98206. U.S.: (206) 356-5400. Canada: (416) 890-7600. Other countries: (206) 356-5500. © 1990 John Fluke Mfg. Co., Inc. All rights reserved. Ad. no. 0701-F70

FROM THE WORLD LEADER  
IN DIGITAL MULTIMETERS.

**FLUKE**®



# December 1990

Radio  
Electronics®

Vol. 61 No. 12

## BUILD THIS

- 33 BENCHTOP FREQUENCY COUNTER**  
Build an inexpensive, full-function frequency counter.  
**Carl Bergquist**
- 40 THE CHRISTMAS CARD**  
Our electronic Christmas tree makes a bright holiday greeting!  
**Ron Holzwarth**
- 48 TELEPHONE CALL SCREENER**  
Put an end to junk calls.  
**John G. Koller**

## TECHNOLOGY

- 63 CHOOSING THE RIGHT TEST PROBE**  
It's important to know which probe meets your testing needs.  
**Bill Hansen**

## COMPUTERS

- 57 SUSIE**  
Simplify digital design using SUSIE, the Standard Universal Simulator for Improved Engineering.  
**TJ Byers**
- 86 COMPUTER CONNECTION**  
An electronics-lab simulation program.  
**Jeff Holtzman**

## DEPARTMENTS

- |   |  |
|---|--|
| <p><b>6 VIDEO NEWS</b><br/>What's new in this fast-changing field.<br/><b>David Lachenbruch</b></p> | <p><b>76 AUDIO UPDATE</b><br/>The amplifier-transfer-function controversy.<br/><b>Larry Klein</b></p>      |
| <p><b>24 EQUIPMENT REPORTS</b><br/>Radio Shack's Micronta Voice Meter.</p>                          | <p><b>78 DRAWING BOARD</b><br/>Keeping the DTMF-generator circuit simple.<br/><b>Robert Grossblatt</b></p> |
| <p><b>69 HARDWARE HACKER</b><br/>Santa Claus machine update, and more!<br/><b>Don Lancaster</b></p> | <p><b>81 IC SPOTLIGHT</b><br/>What's new in IC and systems development.<br/><b>Mike Mullin</b></p>         |



SUSIE simplifies digital design, and makes breadboards a thing of the past.

**57 SUSIE**  
Simplify digital design using SUSIE, the Standard Universal Simulator for Improved Engineering. This program allows you to simulate digital logic circuits on your computer. It's easy to use and can help you save time and money by catching errors before you build a circuit. SUSIE is available for IBM PC, XT, and AT, and is priced at \$49.95.

**PAGE 57**

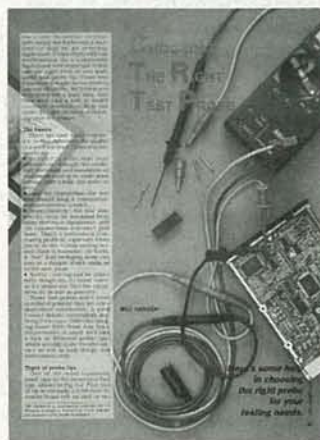

**PAGE 63**

## AND MORE

- 100 Advertising and Sales Offices**
- 100 Advertising Index**
- 8 Ask R-E**
- 49 Free Information Card**
- 16 Letters**
- 91 Market Center**
- 30 New Lit**
- 26 New Products**
- 4 What's News**



## ON THE COVER



'Tis the season... when we all wrack our brains to come up with unique gift ideas. This year, we've made it easy, with a project that's right in the spirit of the holiday season. Our Electronic Christmas Tree is really a PC board whose traces form the branches. Multi-colored LED's look like Christmas-tree lights, and blink in time with any kind of audio. Turn to page 40 to see our festive project that makes a great holiday greeting or window display. And if your wallet's feeling the pinch of holiday shopping, you'll appreciate our Benchtop Frequency Counter. Half the price of commercial models, it offers an impressive array of functions. The versatile, easy-to-use instrument is based on the Intersil ICM7216C. To find out more, turn to page 33.

## COMING NEXT MONTH

### THE JANUARY ISSUE GOES ON SALE DECEMBER 4.

#### BUILD A MACINTOSH

Use an Apple motherboard to build your own Macintosh computer —for a fraction of what Apple charges.

#### R-E's E-Z SHORTWAVE RADIO

Build it, then modify it to receive any frequency that you're interested in!

#### NEGATIVE-ION GENERATOR

Experiment with high-voltage electronics and the effects of negative ions.

#### BATTERIES

A review of rechargeable-battery technology.

#### 1990 ANNUAL INDEX

A complete listing of our feature articles and departments.

As a service to readers, RADIO-ELECTRONICS publishes available plans or information relating to newsworthy products, techniques and scientific and technological developments. Because of possible variances in the quality and condition of materials and workmanship used by readers, RADIO-ELECTRONICS disclaims any responsibility for the safe and proper functioning of reader-built projects based upon or from plans or information published in this magazine.

Since some of the equipment and circuitry described in RADIO-ELECTRONICS may relate to or be covered by U.S. patents, RADIO-ELECTRONICS disclaims any liability for the infringement of such patents by the making, using, or selling of any such equipment or circuitry, and suggests that anyone interested in such projects consult a patent attorney.

RADIO-ELECTRONICS, (ISSN 0033-7862) December 1990. Published monthly by Gernsback Publications, Inc., 500-B Bi-County Boulevard, Farmingdale, NY 11735 Second-Class Postage paid at Farmingdale, NY and additional mailing offices. Second-Class mail registration No. 9242 authorized at Toronto, Canada. One-year subscription rate U.S.A. and possessions \$17.97, Canada \$23.97, all other countries \$26.97. All subscription orders payable in U.S.A. funds only, via international postal money order or check drawn on a U.S.A. bank. Single copies \$2.95. © 1990 by Gernsback Publications, Inc. All rights reserved. Printed in U.S.A.

**POSTMASTER:** Please send address changes to RADIO-ELECTRONICS, Subscription Dept., Box 55115, Boulder, CO 80321-5115.

A stamped self-addressed envelope must accompany all submitted manuscripts and/or artwork or photographs if their return is desired should they be rejected. We disclaim any responsibility for the loss or damage of manuscripts and/or artwork or photographs while in our possession or otherwise.

**Radio  
Electronics®**

Hugo Gernsback (1884-1967) founder  
M. Harvey Gernsback,  
editor-in-chief, emeritus

Larry Steckler, EHF, CET,  
editor-in-chief and publisher

#### EDITORIAL DEPARTMENT

**Brian C. Fenton**, editor  
**Marc Spiwak**, associate editor  
**Daniel Goodman**, technical editor  
**Kim Dunleavy**,  
assistant technical editor  
**Teri Scaduto**, assistant editor  
**Jeffrey K. Holtzman**  
computer editor  
**Robert Grossblatt**, circuits editor  
**Larry Klein**, audio editor  
**David Lachenbruch**  
contributing editor  
**Don Lancaster**  
contributing editor  
**Richard D. Fitch**  
contributing editor  
**Kathy Terenzi**, editorial assistant

#### ART DEPARTMENT

**Andre Duzant**, art director  
**Injae Lee**, illustrator  
**Russell C. Truelson**, illustrator

#### PRODUCTION DEPARTMENT

**Ruby M. Yee**, production director  
**Janice Box**,  
editorial production  
**Karen S. Tucker**  
advertising production  
**Marcella Amoroso**  
production assistant

#### CIRCULATION DEPARTMENT

**Jacqueline P. Cheeseboro**  
circulation director  
**Wendy Alanko**  
circulation analyst  
**Theresa Lombardo**  
circulation assistant  
**Michele Torriello**, reprint bookstore

Typography by Mates Graphics  
Cover photo by Diversified Photo  
Services

**Radio-Electronics** is indexed in  
*Applied Science & Technology Index*  
and *Readers Guide to Periodical Literature*.

Microfilm & microfiche editions are  
available. Contact circulation department  
for details.

**Advertising Sales Offices listed  
on page 100.**

The  
Audit  
Bureau  
of Circulation





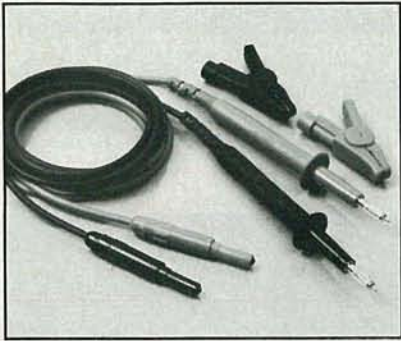

### ECONOMICAL SILICONE RUBBER TEST LEADS

Best value in moderately priced leads. High quality, soft, silicone rubber cable. Banana plug on measuring tip accepts push-on accessories; alligator clips included. Plugs have spring-loaded safety sleeves. Model TL1000 \$14.00 Satisfaction guaranteed.

**TEST PROBES, INC.** Call toll-free for catalog: 1-800-368-5719

**CIRCLE 226 ON FREE INFORMATION CARD**

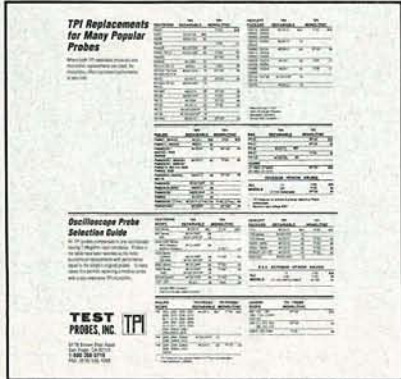

### FREE PROBE REFERENCE GUIDE

One-page chart lists TPI probes for most oscilloscopes. Also cross references other probes to less expensive TPI equivalents. Performance and satisfaction guaranteed.

**TEST PROBES, INC.** Call toll-free for guide and catalog. 1-800-368-5719

**CIRCLE 227 ON FREE INFORMATION CARD**

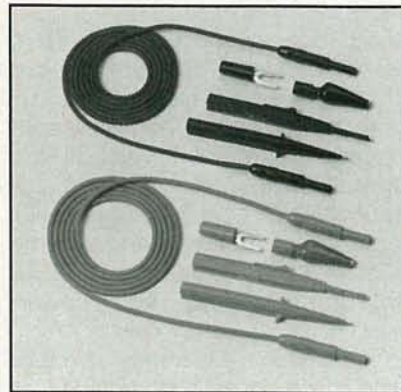

### DELUXE TEST LEAD KIT

Users call TPI leads **The Absolute Best**. The TLS2000 features the highest quality cable in the industry - with spring-loaded safety-sleeved plugs. U.L. listed (file E79581). Kit: \$30 Leads and probes only: \$19 Satisfaction guaranteed.

**TEST PROBES, INC.** Call toll-free for catalog: 1-800-368-5719

**CIRCLE 228 ON FREE INFORMATION CARD**



### COAX ADAPTER KIT

- Create any adapter in seconds
- Make all combinations of BNC, TNC, SMA, N, UHF, Mini-UHF, F and RCA.

The TPI 3000A kit contains male and female connectors of all 8 types, and 6 universal interfaces. Simply screw any combination of 24 connectors to one of the interfaces to create the desired adapter. \$150

**TEST PROBES, INC.** 9178 Brown Deer Road, San Diego, CA 92121. Call toll-free for catalog: 1-800-368-5719

**CIRCLE 225 ON FREE INFORMATION CARD**

## The World's Most Popular Probe



Model SP100 \$43  
100 MHz Switchable 1x-10x ....

**CIRCLE 180 ON FREE INFORMATION CARD**

### More SP100 Probes Have Been Sold Worldwide Than Any Other Probe Ever Made

- For Tektronix, Hewlett Packard, Philips, Leader, B&K, Kikusui, Hitachi, Beckman and other oscilloscopes
- Immediate delivery from distributor stock
- **Economical** - Substantial savings compared to OEM probes
- **Durable** - Unique cable is slim, very flexible and resists breakage
- 10 day return policy - Guaranteed performance and quality

Free cross reference chart for all makes of scopes and probes. Call toll-free for chart and name of your local distributor.

**TEST PROBES, INC. TPI**

9178 Brown Deer Road  
San Diego, CA 92121  
Toll Free 1-800-368-5719

**CIRCLE 123 ON FREE INFORMATION CARD**



# WHAT'S NEWS

*A review of the latest happenings in electronics.*

## The "new" NESDA

The entire by-laws of the National Electronics Sales & Service Dealers Association (NESDA) were replaced with new ones at membership voting sessions held last August at the annual National Professional Electronics Convention (NPEC) in Las Vegas, NV. Although the rules were completely rewritten, the actual changes in NESDA operations are few, and mainly involve shifting control from the state to the national level. The new laws allow NESDA to control its own destiny as a national association instead of being controlled by state organizations. Under the new rules, NESDA will control the billing of all members, but will encourage "Associate" ventures with regional, state, and local organizations. Local billing will still be permitted under certain conditions. Other changes that were made included replacing the NESDA House of Representatives and Regional Vice Presidents with a Board of Directors.

Elections for several positions were held at the convention, which was attended by more than 600 people. Elected as president of NESDA was Cornelius C. ("Connie") Bell, retired owner of C.C. Bell Electronics in St. Louis, MO. Bill Warren, CET/CSM, of Warren's Audio & Video Service of Knoxville, TN was elected vice president. The ten members of the Board of Directors were also chosen.

## Intense laser beam

Researchers at Bellcore (Middletown Township, NJ) have discovered a way to focus 160 extremely small laser beams into a single, powerful beam. Separately, each surface-emitting laser is virtually invisible to the naked eye, measuring about one-tenth the diameter of a human hair, and does not generate enough power for useful applications. The energy that can be harnessed from the experimental arrays, on the other hand, could be used on microchips in optical computers and neural networks or possibly for creating holographic images.



**DR. ROBERT TINKER (LEFT), CHIEF SCIENCE OFFICER OF TECHNICAL Education Research Centers, a non-profit organization committed to improving science and mathematics education, was presented with the first Siemens Award for the Advancement of Science at the Computerworld Smithsonian awards event held at the National Building Museum in Washington, D.C. The innovative educator is credited with first introducing networked programs using computer technology into the science classroom. He has developed such influential programs as the National Geographic Kids Network, the Star Schools program, LabNet, and the Global Lab, which engages students, teachers, and scientists around the world in tackling ecological problems. According to Hans Decker (right), president of Siemens Corporation, "Dr. Tinker's vision of children as scientists, tackling real world problems, makes him the ideal recipient of this award."**

When the microscopic lasers are packed close together, they each receive a uniform amount of electrical current and can "lase" in concert. Bellcore's array consists of surface-emitting lasers, which direct light up off the surface instead of horizontally, allowing many more lasers to be packed onto a single microchip. According to Hoi Jun Yoo, the principal researcher, "Since you can place lasers anywhere on the surface of a chip, you can make the best of available "chip real estate." The small lasers require about 10,000 times less space than semiconductor lasers used in similar limited applications today.

When etched onto a semiconductor in a special array of 160 2-micron-diameter lasers spaced 0.2-microns

apart (one micron equals a 40-millionth of an inch), the vertical beams of light generated blend with one another through a phenomenon called "phase locking," whereby different optical fields overlap to create the equivalent of one light source. The result is the creation of one extremely narrow beam, analogous to several small streams feeding into a powerful river.

The Bellcore experiment is the first time scientists have managed to successfully harness surface-emitting lasers to form a single laser light source.

The research team is now working to integrate the prototype arrays with electronic devices that will be able to accurately control and steer the direction of the beam.

**R-E**



# ELENCO & HITACHI PRODUCTS AT DISCOUNT PRICES

**NEW!** RSOs (Real-Time & Storage Oscilloscopes) From HITACHI **NEW!**  
The RSO - its the new solution  
View, Acquire, Test, Transfer and Document Your Waveform Data

**4-Channel, 100MS/s Model** **Introductory Price**  
100MS/s (25MS/s on 4 channels simultaneously), 100MHz, 4kw x 1ch., 2kw x 2ch., 1kw x 4ch. VC-6145 \$4,695.00

**Compact, Full Feature Models**  
40MS/s, 100MHz, 4kw x 1ch., 2kw x 2ch. VC-6045 \$3,049.00  
20MS/s, 50MHz, 2kw x 2ch. VC-6025 \$2,295.00

**Low Cost/High Value Models**  
20MS/s, 50MHz, 2kw x 2ch. VC-6024 \$2,049.00  
20MS/s, 20MHz, 2kw x 2ch. VC-6023 \$1,749.00

RSOs from Hitachi feature such functions as roll mode, averaging, save memory, smoothing, interpolation, pretriggering, cursor measurements, plotter interface, and RS-232C interface. With the comfort of analog and the power of digital.



V-422 40MHz Dual Trace \$795

**V-212 Hitachi Portable Scopes**  
**\$435**  
DC to 20MHz Dual Channel  
DC to 50MHz, 2-Channel, DC offset function, Alternate magnifier function  
V-525 CRT Readout, Cursor Meas. \$1,025  
V-523 Delayed Sweep \$995  
V-522 Basic Model \$895

## 20MHz Elenco Oscilloscope



**\$375**  
MO-1251  
• Dual Trace  
• Component Tester  
• 6" CRT  
• X-Y Operation  
• TV Sync  
• 2 p-1 Probes

**FREE DMM**  
with purchase of  
**ANY SCOPE**

### SCOPE PROBES

P-1 65MHz, 1x, 10x \$19.95  
P-2 100MHz, 1x, 10x \$23.95

## Compact Series Scopes



Delayed Sweep  
Lightweight (13lbs)  
2mV Sens  
3 Yr Warranty

Model V-1065  
Shown

This series provides many new functions such as CRT Readout, Cursor measurements (V-1085/1065/665), Frequency Ctr (V-1085), Sweetime Autoranging and Trigger Lock using a 6-inch CRT. You don't feel the compactness in terms of performance and operation.

V-660 60MHz Dual Trace \$1,195  
V-665 60MHz Dual Trace w/Cursor \$1,345  
V-1060 100MHz Dual Trace \$1,425  
V-1065 100MHz Dual Trace w/Cursor \$1,695  
V-1085 100MHz Quad Trace w/Cursor \$2,045  
V-1100A 100MHz Quad Trace w/Cursor \$2,295  
V-1150 150MHz Quad Trace w/Cursor \$2,775

## Elenco 35MHz Dual Trace

Good to 50MHz **\$495**



MO-1252

- High luminance 6" CRT
- 1mV Sensitivity
- 6KV Acceleration Voltage
- 10ns Rise Time
- X-Y Operation • Z Axis
- Delayed Triggering Sweep
- Includes 2 P-1 Probes

All scopes include probes, schematics, operators manual, and 3 year (2 yrs for Elenco scopes) world wide warranty on parts & labor. Many accessories available for all Hitachi scopes. Call or write for complete specifications on these and many other fine oscilloscopes.

**WE NOW CARRY COMPLETE LINE OF FLUKE MULTIMETERS Models**

- 21F 83
- 23F 85
- 25F 87
- 27F 8050A
- 73 8060A
- 75 8062A
- 77F + More

**CALL FOR SPECIAL PRICING**

**True RMS 4 1/2 Digit Multimeter**  
**M-7000**  
**\$135**  
.05% DC Accuracy  
.1% Resistance with Freq. Counter and deluxe case

**10 Function Multimeter**  
**CM-365**  
**\$65**  
AC + DC Voltage & Amps  
Resistance to 2000MΩ  
Diode, Logic, & Trans test  
Capacitance to 200uF

**Digital Capacitance Meter**  
**CM-1550**  
**\$58.95**  
9 Ranges  
.1pf-20,000ufd  
.5% basic accy  
Zero control with case

**Digital LCR Meter**  
**LC-1801**  
**\$125**  
Measures:  
Coils 1uH-200H  
Caps .1pf-200uf  
Res .01-20M

**Function Generator**  
**Blox**  
**#9600**  
**\$28.95**  
Provides sine, triangle, square wave from 1Hz to 1MHz  
AM or FM capability

**Triple Power Supply XP-620**  
**Assembled \$65**  
**Kit \$45**  
2 to 15V at 1A,  
-2 to -15V at 1A  
(or 4 to 30V at 1A)  
and 5V at 3A  
Contains all the desired features for doing experiments.  
Features short circuit protection, all supplies.

**Wide Band Signal Generators**  
**SG-9000**  
**\$129**  
RF Freq 100K-450MHz  
AM Modulation of 1KHz  
Variable RF output  
SG-9500 w Digital Display and 150MHz built-in Counter \$249

**AC Current Meter**  
**ST-1010**  
**\$69.95**  
1000 Amps  
Data & Peak hold  
8 Functions  
Deluxe Case

**Decade Blox**  
#9610 or #9620  
**\$18.95**  
#9610 Resistor Blox  
47 ohm to 1M & 100K pot  
#9620 Capacitor Blox  
47pf to 10MFD

**Quad Power Supply XP-580**  
**\$59.95**  
2-20V at 2A  
12V at 1A  
5V at 3A  
-5V at .5A  
Fully regulated and short circuit protected  
XP-575 without meters \$39.95

**LEARN TO BUILD AND PROGRAM COMPUTERS WITH THIS KIT!**  
INCLUDES: All Parts, Assembly and Lesson Manual  
**Model MM-8000**  
**\$129.00**

**Digital Triple Power Supply XP-765**  
**\$249**  
0-20V at 1A  
0-20V at 1A  
5V at 5A  
Fully regulated, Short circuit protected with 2 limit control, 3 separate supplies  
XP-660 with Analog Meters \$175

**GF-8016 Function Generator with Freq. Counter**  
**\$249**  
Sine, Square, Triangle Pulse, Ramp, .2 to 2MHz  
Freq Counter .1 - 10MHz  
GF-8015 without Freq. Meter \$179

Starting from scratch you build a complete system. Our Micro-Master trainer teaches you to write into RAMs, ROMs and run a 8085 microprocessor, which uses similar machine language as IBM PC. You will write the initial instructions to tell the 8085 processor to get started and store these instructions in permanent memory in a 2816 E<sup>2</sup> PROM. Teaches you all about input and output ports, computer timers. Build your own keyboard and learn how to scan keyboard and display. No previous computer knowledge required. Simple easy to understand instruction teaches you to write in machine language.  
**ROBOTICS KIT FOR ABOVE (MM-8010) \$71.95**

**WE WILL NOT BE UNDERSOLD!**  
UPS Shipping: 48 States 5%  
(\$10 Max) IL Res., 7% Tax

**C & S SALES INC.**  
1245 Rosewood, Deerfield, IL 60015  
(800) 292-7711 (708) 541-0710

**15 Day Money Back Guarantee**  
**2 Year Warranty** Prices subject to change  
**WRITE FOR FREE CATALOG**

CIRCLE 109 ON FREE INFORMATION CARD



# VIDEO NEWS

What's new in the fast-changing video industry.

DAVID LACHENBRUCH

• **Who's No. 2?** Philips has ended Zenith's long-time reign as one of the two largest suppliers of TV sets for the American market. The Dutch-owned company's four American brands—Magnavox, Sylvania, Philips, and Philco—aggregated 12.2% of American TV sales in the 1990 model year (mid-1989 to mid-1990), topping Zenith's 11.65% to become America's second largest source of TV's, according to the annual market share survey conducted by *Television Digest*. Thomson Consumer Electronics, a French-owned company, continued to be far and away the leader, its RCA and GE brands aggregating 22.5% of the market.

Philips' advance marked the first time in the 23 years since the *TV Digest* survey has been conducted that the first two places weren't occupied by the manufacturers of RCA and Zenith TV sets. Zenith is the only major U.S.-owned TV-set manufacturer, although some 20 companies have U.S. TV assembly or manufacturing plants. Strictly on the basis of brand names (as opposed to manufacturers), Zenith was still No. 2, following RCA, and Magnavox was the third most popular brand, followed by Sony.

• **Super-Interactivity.** The ultimate in interactive laserdiscs has been demonstrated by Warner New Media, a part of Time Warner Inc. The 12-inch disc will play for one hour per side (as opposed to the 30 minutes normally associated with interactive discs). It can accommodate four simultaneous video tracks with four selectable audio tracks, for a total of 16 combinations. In one suggested application, a viewer could select any of four different views of the same event, with constant audio. The system can display subtitles in up to 15 different languages.

In addition to the main digital stereo channels, it can have 16-channel sound. The channels are mixable—for example, each channel could have a different instrument of the orchestra. The videodisc could be used

as a sort of super-CD—providing eight hours or more of audio. Although the new super-interactive disc will be compatible with existing laserdiscs and players, it could have special encoded video and audio information available only to those with special players. Warner says that the super discs would use currently available technology and the "LD+" players could cost less than \$1,000. Pioneer and Denon helped develop the system, and they could introduce super players in 1991.

• **Lightvalve projection TV.**

When Hughes Aircraft embraces a product, it's usually a significant one. That's why the consumer-electronics industry pricked up its radar with the rumor that Hughes has a TV set. Hughes is keeping its mouth shut on this one, but it's known to be working with Samsung, the Korean TV manufacturer, on a new type of lightvalve TV projector. Although both companies say nothing has been signed yet, there are some indications that a home product could emerge early in 1992. No details are available on the system, except that it uses a single lightvalve in place of the traditional cathode-ray tubes and that the lightvalve isn't a liquid-crystal device, or LCD. The system is said to be capable of providing high-definition TV. This will be Hughes' second major foray into consumer electronics. Its Sound Retrieval System (SRS) super stereo audio is used with Sony TV's and is expected to be added to high-end RCA TV's within the next year.

• **Still/motion camcorder.**

Quite possibly the biggest flop of the video era is the still-video camera. The reasons for its failure are easy to understand. Who would pay \$600 to \$1,000 and more for a still camera with low resolution and no practical system for making prints? Although still-video cameras have been successful in newspaper photography because the pictures can be transmitted by telephone, they have failed to impress consumers because they

have been more expensive than moving-picture camcorders, and far more costly than film cameras.

Along comes Philips with a super-idea. What's wrong with a combination movie-and-still camcorder? A camcorder made in Philips' Japanese factory for the European semi-professional market can make Super-VHS videos and "high-quality photographic prints," according to the manufacturer. The camcorder uses a  $\frac{2}{3}$ -inch CCD sensor with a resolution of 700,000 pixels, and is claimed to deliver a picture with more than 450 lines of horizontal resolution. Philips will offer a companion printer. It makes good sense to envision future still-picture systems as add-ons to movie camcorders, rather than separate products. Although Philips says that it has no plans to offer the movie/still camcorder in the United States, or as a consumer product, that seems to be a logical next step.

• **A government picture tube.**

The Pentagon's Defense Advanced Research Projects Agency (DARPA) has awarded Zenith a contract to develop its Flat Tension Mask (FTM) technology into a cost-efficient high-definition picture tube. Zenith's FTM system, currently used only for high-priced computer monitors, has a completely flat window-glass faceplate, behind which is a shadow mask held under tension, assuring better color rendition because the mask doesn't expand. Reflections are also held to a minimum because the faceplate is absolutely flat and the glass is treated with a special coating. The government contract is designed to fund a major cost reduction in the new tube. Zenith maintains that the phosphors on the tubes can be printed by a silk-screening process, as opposed to the extremely expensive photographic system currently used for color tubes. If Zenith succeeds in fulfilling the Pentagon contract, it should result in a major improvement in picture tubes, lower costs, and, eventually, a new type of high-definition display. **R-E**



# Your Source for time- and money-saving ideas, practical projects and expert guidance.

An absolutely no-risk guarantee.

## Select 5 Books for only \$4.95

(values to \$126.70) and get a FREE Gift!



1122P \$14.95



3004S \$29.95  
Counts as 2



2881P \$18.95

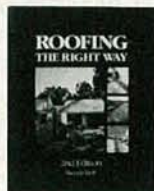

3387 \$24.95  
Counts as 2



3174P \$10.95

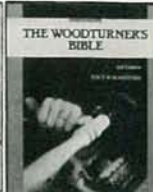

3404 \$26.95  
Counts as 2



2789P \$16.95

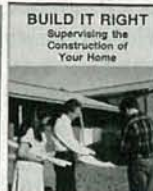

3433 \$24.95



3349 \$21.95



3314 \$22.95



1967P \$11.95



3144 \$25.95  
Counts as 2



3058P \$15.95



3177 \$34.95  
Counts as 2



3326 \$26.95  
Counts as 2



3255 \$26.95  
Counts as 2



3266 \$22.95



3264 \$24.95



3344 \$21.95



3148P \$14.95

**Membership Benefits • Big Savings.** In addition to this introductory offer, you keep saving substantially with members' prices of up to 50% off the publishers' prices. • **Bonus Books.** Starting immediately, you will be eligible for our Bonus Book Plan, with savings of up to 80% off publishers' prices. • **Club News Bulletins.** 15 times per year you will receive the Book Club News, describing all the current selections—mains, alternates, extras—plus bonus offers and special sales, with scores of titles to choose from. • **Automatic Order.** If you want the Main Selection, do nothing and it will be sent to you automatically. If you prefer another selection, or no book at all, simply indicate your choice on the reply form provided. You will have at least 10 days to decide. As a member, you agree to purchase at least 3 books within the next 2 years and may resign at any time thereafter. • **Ironclad No-Risk Guarantee.** If not satisfied with your books, return them within 10 days without obligation! • **Exceptional Quality.** All books are quality publishers' editions especially selected by our Editorial Board.

### FREE when you join!

**Six Easy Home-Improvement Projects**

A treasury of do-it-yourself projects to add value and comfort to your home.



**HOW-TO BOOK CLUB**  
Blue Ridge Summit, PA 17294-0800

Please accept my membership in the How-To Book Club and send the 5 volumes listed below, plus my FREE copy of 6 Easy Home-Improvement Projects (343P), billing me \$4.95. If not satisfied, I may return the books within ten days without obligation and have my membership cancelled. I agree to purchase at least 3 books at regular Club prices during the next 2 years, and may resign any time thereafter. A shipping/handling charge and sales tax will be added to all orders.

Name \_\_\_\_\_  
 Address \_\_\_\_\_  
 City \_\_\_\_\_  
 State \_\_\_\_\_ Zip \_\_\_\_\_ Phone \_\_\_\_\_  
 Signature \_\_\_\_\_

Valid for new members only. Foreign applicants will receive special ordering instructions. Canada must remit in U.S. currency. This order subject to acceptance by the How-To Book Club. RPH1290



3334 \$18.95



1984P \$10.95



3153P \$14.95



3103P \$17.95



2774P \$18.95



3149P \$19.95  
Counts as 2



3269 \$27.95  
Counts as 2



2918 \$18.95



2987P \$16.95



3087P \$14.95



2912P \$14.95



2883P \$17.95

(Publishers' Prices Shown)  
All books are hardcover unless number is followed by a "P" for paperback.

©1990  
HOW-TO BOOK CLUB  
Blue Ridge Summit,  
PA 17294-0800



## ASK R-E

Write to Ask R-E, Radio-Electronics, 500-B Bi-County Blvd., Farmingdale, NY 11735

### VOLTAGE CONVERTERS

**I have a bunch of tools and some stereo equipment that was designed to run on the standard European supply of 220 volts, 50-Hz AC. Isn't there some way I can easily make, buy, or otherwise acquire a transformer that will let me operate those devices off 120 volts, 60-Hz AC?—A. Sfakianos Placitas, NM**

There are lots of places to get transformers that turn 220 volts AC into 110 volts AC, and they should work when their supply connections are reversed as well, but only for the voltage, not the frequency. You indicated in your letter that the frequency difference wasn't important for the equipment you wanted to use so I don't understand why you're having so much trouble.

There are two basic types of commercially available converters used for converting 220 volts AC to 110 volts AC, and they're sold in just about every electronics store; even Radio Shack carries them. With a transformer I use, I can turn the supply leads around and step up the line voltage from 110 volts AC to 220 volts AC (actually 120 to 240). There isn't any problem in doing that as long as you make sure you have the right type of voltage converter.

Converters are made with either transformers or diodes. You can tell the difference between them when you're looking at the package by the weight and the wattage rating. Transformer-based converters are much heavier than the diode-based ones and usually have a maximum rating of about 50 watts or so. The package information should list them as being suitable for electronic equipment, battery chargers, camera flash units, and so on. Since there's a transformer inside the package, the voltage is actually divided in half, (or doubled, when you use it backwards). The output of those converters is a sinusoid.

Diode-based converters are much lighter, and even though the package

is the same size, they usually have a maximum rating of 1000 or 1500 watts. You'll find them recommended for things like heaters, lamps, and so on. If you try and use one of those appliances with a transformer operated converter, you'll probably wind up destroying both the converter and whatever you have plugged into it. With the diode-based converters, you can't turn them around and expect to double the input voltage.

Generally, diode-based converters only produce half-wave rectified AC instead of a full sine wave, and they don't cut the voltage in half either. As with any diode voltage drop circuit, the output is .67 times the input voltage. If you put 220 volts AC across the input, you're going to get about 148 volts AC at the output. That may not be much of a problem for most resistive loads, but you should realize that overdriving a heater is going to make it hotter than it was designed to be and that can cause a real problem.

### ALARM SYSTEM BACKUP

**I've designed an alarm circuit for my house that's powered by line voltage but I want it to switch over to backup batteries if and when the power fails. The control part of the circuit is the only section that has to be constantly powered. I'm not worried about lights and other high current devices since I have a commercial unit for that part of the system. Do you have a simple circuit that can provide the battery backup? I only need 100 milliamps or so.—G. Benjamin Indianapolis, IN**

Having a fail-safe power-supply for a home alarm system is a good idea and, if you think of it, is probably the most important part of the alarm system. Fortunately, it's also one of the easiest things to add to the circuit. In your case, it's even easier, since you designed the alarm-control circuit yourself.

There are several ways to add a battery backup to a circuit, but since

you're only looking for 100 milliamps, you can keep it simple and the backup circuit can be made so small you'll be able to easily find room for it in your existing enclosure.

The circuit shown in Fig. 1 is a simple design that can do the job. When the line voltage is available and operating, D2 is reverse-biased and current flows into the batteries through R1, the current limiter for the nickel-cadmium (Ni-Cd) batteries, or whatever type of rechargeable battery you want to use. If the main power is disconnected (inadvertently by you or intentionally by a burglar), D2 is forward-biased and battery power is available for the alarm circuit. By adding D1 to the circuit, you can keep the battery from powering other circuitry that's not essential to keeping the alarm system active.

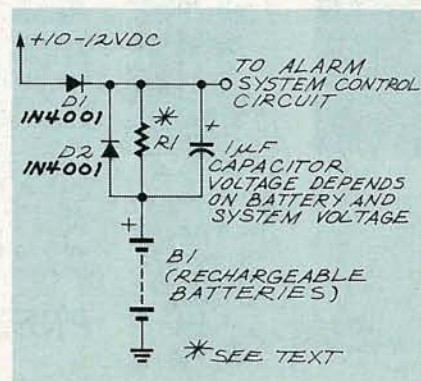

**FIG. 1—THIS SIMPLE BATTERY backup circuit can be used to power a control circuit for an alarm system.**

The particular diode you should use for D2 depends on the amount of power you want to draw from the battery when the main power is disconnected. If you're sure that you'll never need more than 100 milliamps, you can probably get by with a small 1N914 diode but, if there's a chance you might draw more current, or you just want to play it safe, you're better off with something like a 1N4001.

If you use Ni-Cd batteries, you'll need a constant trickle-charging current. You should select R1 to limit the charging current to the battery's C/10 rating, which is 10% of the ca-



# Discover Your Career Potential In The Fast Growing Field Of High-Tech Electronics!

CIE Gives You The Training You Need to *Succeed...*  
At Your Own Pace...& In Your Own Home!

If you're anxious to get ahead...and build a *real* career...you owe it to yourself to find out about the Cleveland Institute of Electronics!

CIE can help you discover your career potential in the fast growing field of high-tech electronics. A career that will challenge and excite you every day...reward you with a powerful feeling of personal accomplishment...and deliver a level of financial security you may have only dreamed of before!

As the leading school in home-study electronics, CIE has helped over 150,000 students in the U.S.A. and over 70 foreign countries get started in this exciting field. To find out how CIE could be helping you...read on...then send for a CIE catalog TODAY!

## A Growing Need For Trained Professionals!

The career opportunities shown here are only a few of the challenging, high-paying careers you could enjoy as an electronics technician.

You could be the "brains" behind the scenes of an exciting TV broadcast...trouble-shoot life-saving medical equipment...design exotic new aeronautics systems...CIE's job-oriented programs offer you the quickest possible path to the career of your dreams! And CIE also features military and union re-training, to build on what you already know.

## Dozens Of Fascinating Careers To Choose From!

Even if you aren't sure which career is best for you, CIE can get you started with core lessons applicable to *all* areas of electronics. As you advance, CIE makes job opportunities available to you through the bimonthly school paper, *The Electron*.



Data Communications

Automotive Electronics

Avionics

Computer-Assisted Manufacturing

Consumer Electronics

Military Electronics

## Personal Training From A Renowned Faculty.

Unlike the impersonal approach of large classroom study, CIE offers you one-on-one instructional help 6 days a week, toll-free. Each CIE lesson is authored by an independent specialist, backed by CIE instructors who work directly with you to answer your questions and provide technical assistance when you need it.

## Practical Training... At Your Own Pace.

Through CIE, you can train for your new career while you keep your present job. Each course allows a generous completion time, and there are no limitations on how fast you can study. Should you already have some electronics experience, CIE offers several courses which start at the intermediate level.

## "State-Of-The-Art" Facilities & Equipment.

In 1969, CIE pioneered the first electronics laboratory course, and in 1984, the first Microprocessor Laboratory. Today, no other home study school can match CIE's state-of-the-art equipment. And all your laboratory equipment is included in your tuition cost. There is no extra charge—it's yours to use while you study at home and on the job after you complete your course!

## Earn Your Degree To Become A Professional In Electronics!

Every CIE course you take earns you credit towards the completion of your Associate in Applied Science Degree, so you can work towards your degree in

stages. And CIE is the only school that awards you for fast study, which can save you thousands of dollars in obtaining the same electronics education found in four-year Bachelor's Degree programs! Write for details today!

## Send For Your Catalog Today!



### CIE World Headquarters

Cleveland Institute of Electronics, Inc.  
1776 East 17th St., Cleveland, Ohio 44114

**YES!** Please send me your independent study catalog (For your convenience, CIE will have a representative contact you—*there is no obligation.*)

Print Name \_\_\_\_\_

Address \_\_\_\_\_ Apt # \_\_\_\_\_

City/State/Zip \_\_\_\_\_

Age \_\_\_\_\_ Area Code/Phone No. \_\_\_\_\_

Check box for G.I. Bill bulletin on educational benefits:  Veteran  Active Duty

## Mail This Coupon Today!

ARE-183

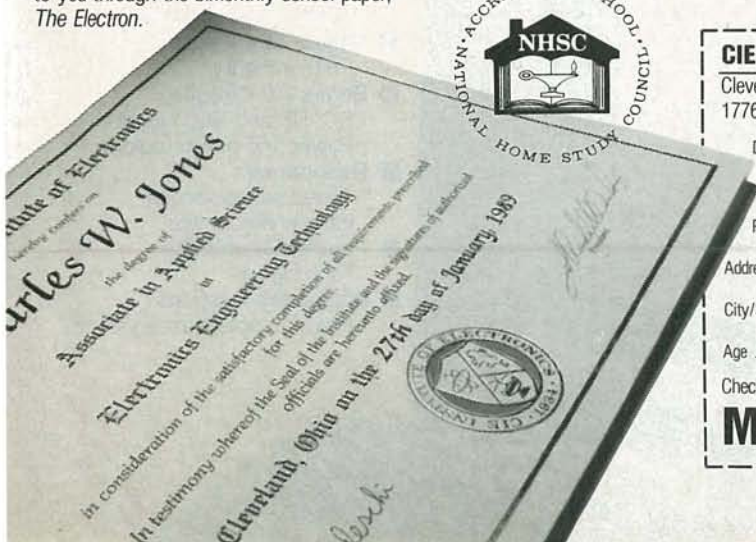



# NEW!

# Create real circuits instantly on your

## Introducing **PROTOLAB™** a total including Free built-in Instruments and Tools to

*Easy to use, menu-driven, mouse controlled  
circuits come alive on your terminal!*

Phase Shift Circuit  
using built-in oscilloscope

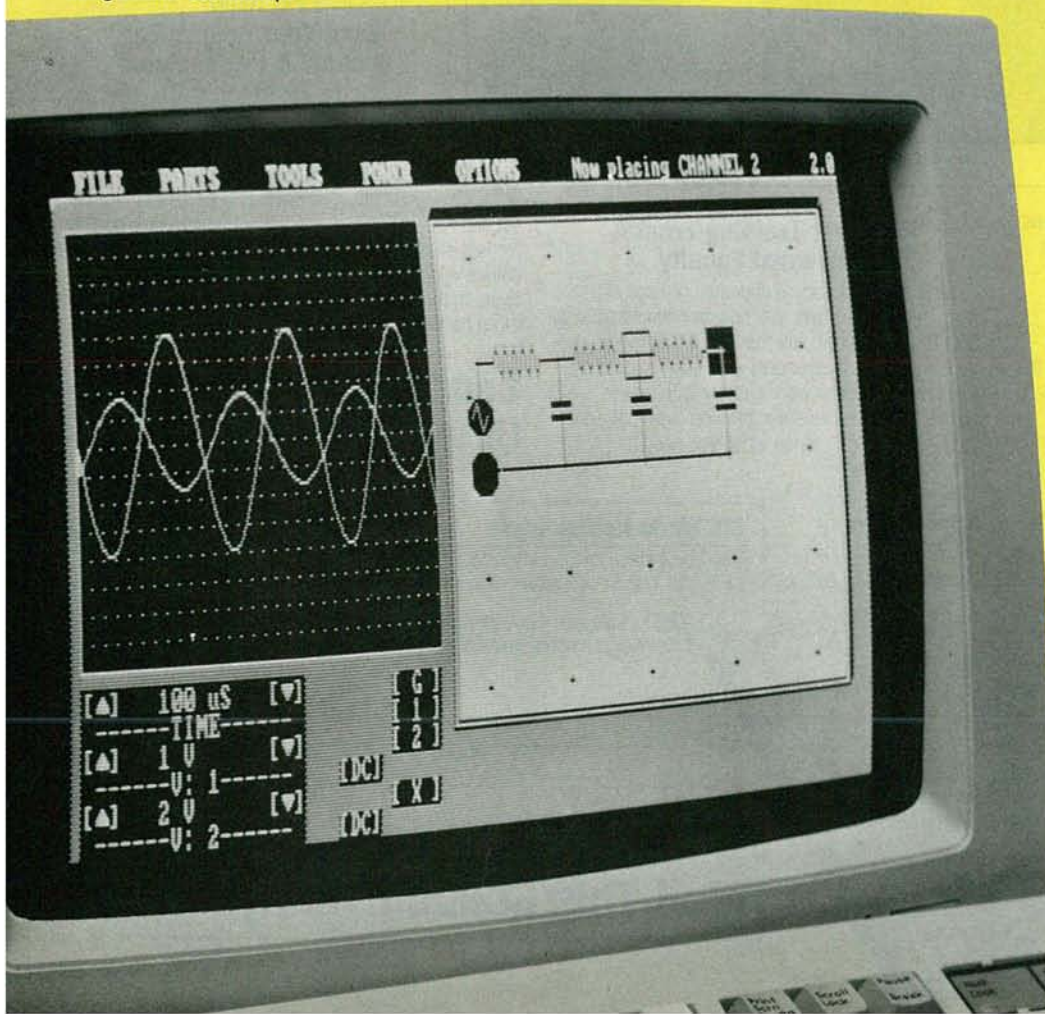

- **DC Series Circuits**  
Ohm's Law • Kirchoff's Voltage Law
- **Temperature Effects**  
Voltage sources • Resistances in series
- **Voltage Dividers**  
Internal source resistance  
Voltage regulation
- **DC Parallel Circuits**  
Networks • Current dividers
- **DC Series-Parallel Circuits**  
DC Circuit analysis by reduction
- **DC Circuit Analysis**  
Mesh circuit and branch current analysis
- **Superposition Theory**  
Circuit analysis using superposition
- **Bridge Circuits**  
Delta - Wye conversions
- **Phasor Mathematics**  
Phasor theory
- **Series AC Circuits**  
RC, RL and RLC circuits  
Power and power factors
- **Resonance**  
Tuned series circuits  
Parallel resonance
- **Parallel Resonance**  
Tank circuits
- **Polyphase Systems**  
Power in polyphase systems



# pc!

## computer simulated electronics laboratory build and test actual circuits.

New PROTO LAB™, a state of the art electronics lab for the hobbyist's, student's or engineer's pc. Now, you can build and experiment with actual circuits, choosing from an unlimited number of components, including resistors, capacitors, inductors, general impedance, AC voltage sources, batteries, AC/DC current sources. Then, analyze

your circuits with built-in high tech instruments — voltmeter, ammeter, ohmmeter, oscilloscope, wattmeter, sweep generator, breadboard, temperature adjustment and frequency control. This complete electronics lab, simulates thousands of dollars worth of parts and instruments . . . all built-in with easy to use, menu driven, mouse controlled PROTOWARE™ software. Plus, you get a unique experiment book, featuring over 75 experiments and circuits. Enjoy countless hours of fun, while learning. And, you won't blow up your "lab", because it's fool proof and safe on your pc.

Here are some typical circuits you can build and test...

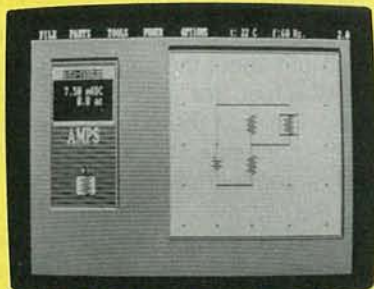

Resistor Series/Parallel Circuit demonstrates current division in a parallel circuit

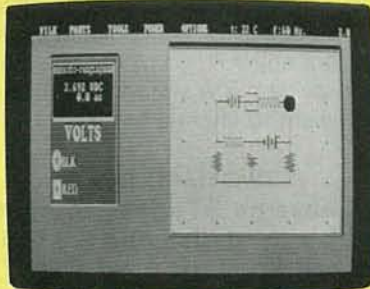

Thevenin Equivalent Circuit calculating voltage drop and current flow using built-in ammeter/voltmeter

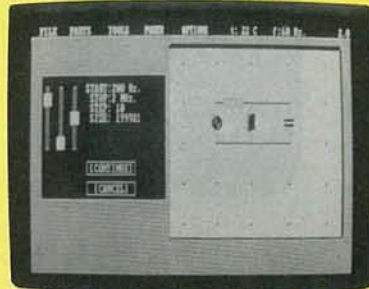

Parallel Resonance LC Tank Circuit using sweep generator to vary voltage across tank, monitoring circuit response

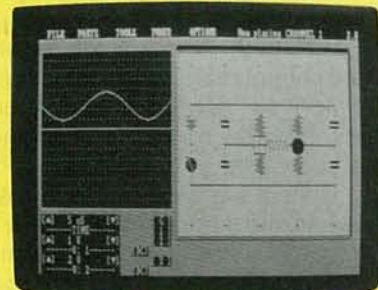

Frequency Compensated Bridge using oscilloscope to measure AC signal offset by DC voltage

PROTO LAB provides a complete lab station of high tech equipment including...

Temperature Adjustment

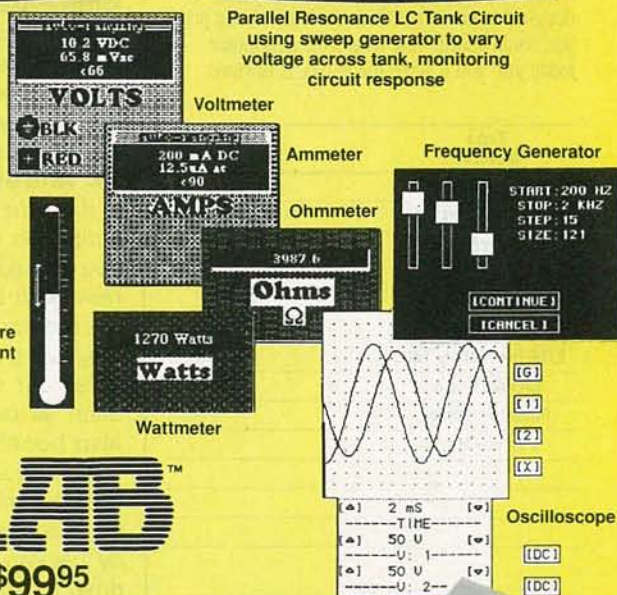

Order today...  
start building  
and testing  
circuits today...

# PROTO LAB™

Complete, for IBM/compatibles\*... ONLY \$9995

For Macintosh with high resolution, enhanced graphics\*\*... \$12995

\*IBM/compatibles require 384K RAM, CGA [640x200] video display and mouse  
\*\*Macintosh requires Macintosh 512E, MAC XL, MAC PLUS, MAC SE, MAC II

Includes lab experiment book and exclusive PROTOWARE™



Call toll-free for details  
1-800-572-1028

**GLOBAL SPECIALTIES**

Global Specialties,  
70 Fulton Terrace, New Haven, CT 06512.  
Telephone: [203] 624-3103. © Interplex Electronics, 1990.  
All Global Specialties breadboarding products made in USA.



A021

CIRCLE 189 ON FREE INFORMATION CARD



# It's no fluke.



Building the best DMM for the money is no accident. The new RMS225 was carefully designed to give you what you wanted at a price you could afford. Visit your local distributor today and you'll agree the choice is obvious.

<b>Fluke Model 77</b>
3-1/2 Digits
3,200 Counts
0.3% Accuracy
Touch Hold®
31 Segment Analog Bar Graph
2,000 Hour Battery Life
10A Range (Fused)
Protective Holster
3 Yr. Warranty
<b>\$159*</b>

® Touch Hold is a registered trademark of the John Fluke Mfg. Co., Inc. \*1990 Fluke and Philips Catalog

**Beckman Industrial™**  
An Affiliate of Emerson Electric Co.

Instrumentation Products Division  
3883 Ruffin Road, San Diego, CA 92123-1898  
(619) 495-3200 • FAX (619) 268-0172 • TLX 249031  
Outside California 1-800-854-2708 Within California 1-800-227-9781  
© 1990 Beckman Industrial Corporation. Specifications subject to change without notice. Fluke is a registered trademark of John Fluke Mfg. Co., Inc.  
JN190-01-1290

CIRCLE 98 ON FREE INFORMATION CARD

capacity of the battery. In a C/10 rating, "C" is the charge capacity in amp-hours, and "10" is the number of hours the battery can supply useful power. Therefore, the capacity divided by that operating interval equals the maximum current safely drawn from or supplied to the battery. The trickle current charge,  $I_c$ , must be less than or equal to the maximum safe current drawn through the battery.

The value of R1 can easily be calculated using

$$R1 = [(V_c - (0.6 \text{ volts} + V_b)] / I_c$$

where  $V_c$  is the circuit voltage,  $V_b$  is the battery voltage, and  $I_c$  is the charging current.

This is just a straight application of Ohm's Law. The reason it seems more complex is that you have to subtract the 0.6 volt-diode drop and battery voltage from the supply voltage.

The capacitor in the circuit is used to filter any voltage glitches and also to provide a few seconds of power if you want to change batteries.

## TWO HARD DISKS

**I have an AT-class computer with a hard disk and am trying to add a second hard disk. The controller card can work with two hard disks, but I'm not having any luck connecting the cables. No matter what I do, the computer never recognizes the second hard disk.—W. Meredith Philadelphia, PA**

If you're installing the second drive simply to increase capacity, maybe you should consider buying a single new hard drive with at least double the memory of your present one. Not only will that give you extra room inside your cabinet for other add-ons such as tape drives, but you might also benefit from increased overall operating speed—your old drive may not be as fast as the newer ones. You can keep your old drive for emergency backup, or you can sell your old drive to someone who doesn't have one. However, if you're determined to add a second drive, read on.

In order to have two hard disks in your computer, you have to tell the computer the second hard disk is there and then you have to cable it so the computer can find it.

Since you have an AT computer, you have to run the setup utility and set the correct type for the second

hard disk. How that is done depends on the BIOS you have since some of them have the setup utility in ROM while others require that you run a program on a disk, such as the IBM AT diagnostics. Be sure and set the type correctly since an incorrect number there can damage the hard drive.

Once you have that done, you have to physically connect the drive to the computer and that involves four things:

1. A power cable has to be connected to the drive.
2. A separate data cable (the thin one) has to be connected from the controller card to the drive.
3. The control cable (the fat one) has to be connected to the drive.
4. The drive select jumpers on the back of the hard drive have to be set to match the type of control cable you're using.

The first two operations are simple and just about the only thing you have to watch out for is the cable's orientation. Pin 1 on the controller card has to be connected to pin 1 on the drive's edge connector.

The last two items on the list go together since the drive select jumper on the back of the disk has to be set according to the type of control cable you're using.

The first hard disk in the system, (your original one), should be attached to the connector at the end of the control cable and the second hard disk, (your new one), should be attached to the connector in the middle of the cable.

If there's a twist in the wires between the connectors for the two hard disks, the drive select jumpers for both hard disks should be set in the second position (sometimes marked as DS2.) If there's no twist in the cable, the drive at the end (your original one) should have the jumper set in the first position and the drive in the middle of the cable, (your new one), should have the jumper in the second position.

The terminating resistor should be removed from the new drive in the middle of the cable and left on the original drive at the end of the cable. If you can't find the terminating resistor or have a hard time trying to remove it, don't worry about it. I've seen several machines in which both drives had the terminating resistors left in and everything worked fine. **R-E**



# Countersurveillance

**Never before has so much professional information on the art of detecting and eliminating electronic snooping devices—and how to defend against experienced information thieves—been placed in one VHS video. If you are a Fortune 500 CEO, an executive in any hi-tech industry, or a novice seeking entry into an honorable, rewarding field of work in countersurveillance, you must view this video presentation again and again.**

*Wake up!* You may be the victim of stolen words—precious ideas that would have made you very wealthy! Yes, professionals, even rank amateurs, may be listening to your most private conversations.

*Wake up!* If you are not the victim, then you are surrounded by countless victims who need your help if you know how to discover telephone taps, locate bugs, or “sweep” a room clean.

There is a thriving professional service steeped in high-tech techniques that you can become a part of! But first, you must know and understand Countersurveillance Technology. Your very first insight into this highly rewarding field is made possible by a video VHS presentation that you cannot view on broadcast television, satellite, or cable. It presents an informative program prepared by professionals in the field who know their industry, its techniques, kinks and loopholes. Men who can tell you more in 45 minutes in a straightforward, exclusive talk than was ever attempted before.

## Foiling Information Thieves

Discover the targets professional snoopers seek out! The prey are stock brokers, arbitrage firms, manufacturers, high-tech companies, any competitive industry, or even small businesses in the same community. The valuable information they filch may be marketing strategies, customer lists, product formulas, manufacturing techniques, even advertising plans. Information thieves eavesdrop on court decisions, bidding information, financial data. The list is unlimited in the mind of man—especially if he is a thief!

You know that the Russians secretly installed countless microphones in the concrete work of the American Embassy building in Moscow. They converted



**1-800-522-6260**

**HAVE YOUR  
VISA or MC CARD  
AVAILABLE**

what was to be an embassy and private residence into the most sophisticated recording studio the world had ever known. The building had to be torn down in order to remove all the bugs.

## Stolen Information

The open taps from where the information pours out may be from FAX's, computer communications, telephone calls, and everyday business meetings and lunchtime encounters. Businessmen need counselling on how to eliminate this information drain. Basic telephone use coupled with the user's understanding that someone may be listening or recording vital data and information greatly reduces the opportunity for others to purloin meaningful information.

The professional discussions seen on the TV screen in your home reveals how to detect and disable wiretaps, midget radio-frequency transmitters, and other bugs, plus when to use disinformation to confuse the unwanted listener, and the technique of voice scrambling telephone communications. In fact, do you know how to look for a bug, where to look for a bug, and what to do when you find it?

Bugs of a very small size are easy to build and they can be placed quickly in a matter of seconds, in any object or room. Today you may have used a telephone handset that was bugged. It probably contained three bugs. One was a phony bug to fool you into believing you found a bug and secured the telephone. The second bug placates the investigator when he finds the real thing! And the third bug is found only by the professional, who continued to search just in case there were more bugs.

The professional is not without his tools. Special equipment has been designed so that the professional can sweep a room so that he can detect voice-activated (VOX) and remote-activated bugs. Some of this equipment can be operated by novices, others require a trained countersurveillance professional.

The professionals viewed on your television screen reveal information on the latest technological advances like laser-beam snoopers that are installed hundreds of feet away from the room they snoop on. The professionals disclose that computers yield information too easily.

This advertisement was not written by a countersurveillance professional, but by a beginner whose only experience came from viewing the video tape in the privacy of his home. After you review the video carefully and understand its contents, you have taken the first important step in either acquiring professional help with your surveillance problems, or you may very well consider a career as a countersurveillance professional.

## The Dollars You Save

To obtain the information contained in the video VHS cassette, you would attend a professional seminar costing \$350-750 and possibly pay hundreds of dollars more if you had to travel to a distant city to attend. Now, for only \$49.95 (plus \$4.00 P&H) you can view *Countersurveillance Techniques* at home and take refresher views often. To obtain your copy, complete the coupon below or call toll free.

<b>RADIO-ELECTRONICS VIDEO OFFER</b>	<b>RE</b>
500-B Bi-County Blvd. Farmingdale, NY 11735	
Please rush my copy of the Countersurveillance Techniques Video VHS Cassette for \$49.95 plus \$4.00 for postage and handling.	
No. of Cassettes ordered _____	
Amount of payment \$ _____	
Bill my <input type="checkbox"/> VISA <input type="checkbox"/> MasterCard	
Card No. _____	
Expire Date _____ / _____	
Signature _____	
Name _____	
Address _____	
City _____ State _____ ZIP _____	
All payments in U.S.A. funds. Canadians add \$4.00 per VHS cassette. No foreign orders. New York State residents add applicable sales tax.	



# LETTERS

Write to Letters, Radio-Electronics, 500-B Bi-County Blvd., Farmingdale, NY 11735

## LOGIC ANALYZER REANALYZED

The review of the Photronics low-cost logic analyzer (*Editor's Workbench*, **Radio-Electronics**, August 1990) does a terrible injustice to the product in stating that its "low speed" and "8-bit operation" are insufficient. That fact is that its speed and data width are usually *more* than adequate for the application areas for which it was designed.

The LA1 is primarily intended for digital troubleshooting in areas that require more than a dual-trace oscilloscope, a digital voltmeter, and a logic probe while not requiring the power, expense, and complexity of a typical logic analyzer designed for microprocessor applications. When an actual situation places the designer in that predicament, the need for a medial solution becomes obvious. A few examples that prompted the design of the LA1 are stepper-motor logic circuits, remote-control circuits using the popular 40-kHz IR encoding, and countless applications in the non-microprocessor prototype circuits breadboarded by the professional as well as hobbyists and students. Many of those applications do not require all eight data channels or the full bandwidth of the LA1.

Perhaps the label "logic analyzer" automatically conjures up the thought of complex, high-speed, wide-bus microprocessor analysis; nonetheless, that is the most appropriate label for the LA1, which completely accomplishes its design goal by introducing a cost-effective means of obtaining that worthy capability at the other end of the spectrum.

DALE NASSAR  
PRESIDENT, PHOTRONICS  
Amite, LA

*Perhaps I should have said "insufficient for the things people normally use logic analyzers for," which does not include IR decoding, stepper-motor circuits, and so on. I liked the device quite well as a teaching aid, but I remain skeptical of its utility outside the educational environment. That is not to denigrate the device; a balanced review must point out both*

*the strengths and the limitations of a product.—Jeff Holtzman, Computer Editor*

## CABLE SCRAMBLING

I read with interest Robert Grossblatt's *Drawing Board* column, entitled "Scrambling and Macrovision," in the July issue of **Radio-Electronics**. I am only sorry that, as a new subscriber, I have missed some very important information in earlier issues.

However, having worked for the "Phone Factory" for a number of years before retiring, I am well acquainted with COAM (customer owned and maintained) equipment and the pitfalls of the "rules." With divestiture, as Mr. Grossblatt said, we can now connect "most anything" to the line on the COAM side of the RJ block—as long as it doesn't "upset" or interfere with the network. Cable TV, as a franchised company, should operate under the same rules. If they do not want a channel to be available to me, then they shouldn't put it on the network to begin with.

The power company doesn't say that you have to pay higher rates if you have a microwave oven, hair dryer, TV, etc., and I see no reason for any utility to have special concessions. So if they don't want me to have what is on the network, then don't provide it and trap it out—make me the responsible party, not them.  
DELBERT McMULLEN  
*Independence, MO*

## THE "LONG RANGER"

I am responding to the article "Whatever Happened to AM Radio?" (**Radio-Electronics**, September 1990). After 38 years as a small-market chief engineer and announcer, I feel I have some understanding of AM/FM radio.

A new business climate exists today. Most business firms in this rural area are chain outfits. They advertise little on radio, FM or AM. Ten years ago almost all were Mom-and-Pop concerns and, though some didn't

contribute heavily, nearly all advertised. TV and cable were no competition for commercials then or now. But they have captured a large portion of the *audience*. Today, the weekly newspapers, shoppers' guides, and sales flyers get the bulk of advertising dollars.

There are too many AM stations, especially at night. We can receive a half dozen that are relatively free from interference. But one picture is worth a thousand words, so we watch TV at night. And some areas have too many stations, in the day and evening.

The National Association of Broadcaster's (NAB) grand scheme to institute the National Radio Systems Committee's (NRSC) pre-emphasis to AM is largely a wild idea, in my opinion, and will cause additional interference (albeit some improvement in the cheap sets with poor audio quality). The plan is to change back in the future, removing pre-emphasis. Why not attack the problem head on? Yes, even manufacture our own receivers if the Japanese won't cooperate. We have the know-how, the facilities, and plentiful parts.

AM radio, as we old-timers remember it, is gone. But with some prudent managing it is far from dead. In fact, we just might see an AM resurgence in the future—it is definitely the long ranger!

GENE VINSON  
*Thomasville, AL*

## MORE ON AM RADIO

Mr. Dexter's article about the problems facing AM radio contained a serious technical error. Mr. Dexter wrote that AM transmissions are limited to a bandwidth of 10 kHz, and an audio response upper limit of 5 kHz. Actually, the FCC has always allowed AM stations to transmit audio out to 15 kHz (the same as FM radio), with a corresponding RF bandwidth of 30 kHz. AM radio's poor sound quality is because almost all AM receivers have a 10-kHz bandwidth, limiting received audio response to 5 kHz.

When broadcasting began, there was no such thing as "high fidelity."



# DAMARK

INTERNATIONAL, INC.

**ORDER TODAY!**  
**1-800-729-9000**  
 THE "GREAT DEAL" CATALOG

## GoldStar



### 286 AT COMPUTER with 14" HIGH RESOLUTION VGA COLOR MONITOR & 30MB HARD DRIVE

- 80286 microprocessor, 2.5/6.25MHz switchable.
- One MB RAM on motherboard, expandable to four MB.
- 30 MB hard drive.
- One 5.25" 1.2MB floppy drive.
- High resolution VGA monitor: 640 x 480.
- Socket for 80287 math coprocessor.

- 16-bit VGA card; 800x600 res.
- 3 expansion slots—two 16-bit & one 8-bit.

- IBM compatible.
- 1 serial port.
- 1 parallel port.
- PS/2 compatible 6-pin mouse port.
- Real time clock/calendar.
- Phoenix 286 ROM BIOS.
- AT style 101-key enhanced keyboard.
- Includes MS-DOS 4.01 with DOS Shell utilities and GW BASIC™.
- PC dim.: 4-1/4"H x 15"W x 15-1/2"D.
- Monitor dim.: 13.9"W x 14.7"D x 14.1"H.
- One Year Mfr. Warranty!
- Factory New!

**FREE BONUS SOFTWARE:**  
 Spinnaker "Easy Writer" word processing, "Ace2" interaction game & "Splash" demo program. Also includes coupon to buy "Splash" at great savings!

Mfr. Sugg. Retail: **\$2,293.00**  
**DAMARK \$ 999<sup>99</sup>**  
 PRICE

Item No. B-2405-149047  
 Insured Ship/Hand.: \$49.00

## SONY CORDLESS HEADPHONES

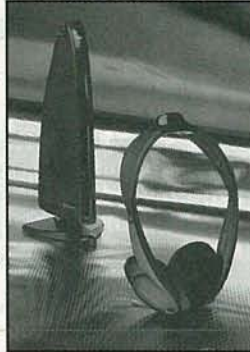

- Infrared wireless stereo headphone system with built-in rechargeable battery.
- Comfortable semi open-air earpads.
- Headphone range: up to 23 feet.
- Volume controls for left & right channels.
- Automatic level-control circuitry for crisp, clean listening.
- Frequency response: 18-22,000Hz.
- Sleek pyramid transmitter serves as a recharger too. Up to 6 hours of operation per charge.
- Japanese construction.
- Lightweight, headphones only 4 oz.
- Easy to use—to listen just plug transmitter into your stereo, TV or VCR.
- Includes AC adaptor and mini-plug adaptor.
- Pyramid transmitter dim.: 9"H x 3-1/2"W x 4"D.
- Model #: MDR-IF5K.
- One Year Mfr. Warranty!
- Factory New!

Mfr. Sugg. Retail: **\$199.95**  
**DAMARK \$ 129<sup>99</sup>**  
 PRICE

Item No. B-2405-148023  
 Insured Ship/Hand.: \$6.50

## XEROX FAX TELECOPIER



- Send and receive documents—simply hook up your telephone to the fax.
- Send a portion of a document or the entire document!
- Select from fast or standard sending speeds.
- Test Document feature allows you to check for copy quality problems.
- Group II compatible.
- Jam removal function.
- Ready lamp informs you to load document.
- Fast sending speed: 4 minutes.
- Fault lamp indicator.
- On-line lamp indicates machine is connected to phone line.
- Documents sent can be from 8 to 8-1/2"W x 5 to 11-3/4"L.
- Model #: 455.
- Dim.: Approx. 18" x 18" x 5-1/2".
- Factory serviced, but like new!
- 90 Day Warranty!

Mfr. Sugg. Retail if new: **\$2,199.00**  
**DAMARK \$ 299<sup>99</sup>**  
 PRICE

Item No. B-2405-117556  
 Insured Ship/Hand.: \$20.00

## Southwestern Bell Freedom Phone

### CORDLESS SPEAKER PHONE FF1700



- Range: approx. 1000 ft. with built-in range extending antenna.
- 46/49 MHz duplex.
- Cordless, integrated speakerphone with volume control.
- 2 separate keypads: one on handset and one in base.
- 9 number auto dialing plus auto redial.
- Built-in two-way intercom with hold.
- 10-channel selectable.
- Pulse/tone switchable.
- Digital coded security.
- Status-indicator lights.
- Includes 3 rechargeable nickel cadmium batteries.
- Snap-out battery pack.
- Color: Almond.
- Dim.: 10"D x 2-1/2"H x 6-1/2"W.
- Model #: FF-1700.
- Factory serviced, but like new.
- 90 Day Manufacturer's Warranty!

**Dual keypad, speaker- phone!**

Mfr. Sugg. Retail if new: **\$179.95**  
**DAMARK \$ 79<sup>99</sup>**  
 PRICE

Item No. B-2405-150680  
 Insured Ship/Hand.: \$7.00

## TOSHIBA 24-PIN DOT MATRIX PRINTER



- 24-pin letter quality printer.
- Print speed: 216 CPS draft; 72 CPS letter quality, 32K buffer.
- Includes: 12 Multi-Strike Ribbons PLUS 2 Font Cards—no choice on font cards received.
- Built-in rear tractor.
- Friction feed.
- Auto loading, single sheet guide for letterhead & cut sheets & friction feed.
- Front panel LCD display includes: type fonts, pitch, emulation, lines per inch, quiet mode and page length.
- 360 x 360 graphics.
- Tractor feed and tear bar for continuous forms.
- IBM emulation.
- Single or continuous feed paper loading.
- Parallel/serial ports included.
- Model #: P321SL.
- Dim.: 16.3"W x 3.9"H x 15"D.
- 1 Yr. Ltd. Mfr. Warranty!
- Factory New!

**Sheetfeeder**  
 • Model #: MS-17.  
 Mfr. Sugg.: **\$349.00**  
**DAMARK \$ 49<sup>99</sup>**  
 PRICE

**Includes printer ribbon & font cards.**  
 Mfr. Sugg. Retail: **\$1019.00**  
**DAMARK \$ 299<sup>99</sup>**  
 PRICE

Item No. B-2405-149468  
 Insured Ship/Hand.: \$29.00

## SmartMax Fax/Phone Auto Switch



**FACTORY NEW!**

- No need for a dedicated fax line.
- Fax/phone auto switch allows your new fax to share existing phone line.
- Works on Group 3 fax machines.
- Single switch to lock out either voice or fax calls.
- Front panel status lights indicate modes of operation.
- SmartMax handles power outages by automatically switching to phone-only mode.
- Allows manual override so you can send a fax to the person you're talking to on the phone.
- 24-Hour customer service line.
- Easy installation.
- U.L. listed.
- FCC certified.
- Dim.: 4" x 7" x 1-1/2".
- Wt.: 2-1/2" lbs.
- Model #: MX 1030.
- 2 Yr. Mfr. Warranty!

Mfr. Sugg. Retail: **\$245.00**  
**DAMARK \$ 99<sup>99</sup>**  
 PRICE

Item No. B-2405-128934  
 Insured Ship/Hand.: \$7.50

**FOR FASTEST SERVICE CALL TOLL FREE**  
**1-800-729-9000**

CUSTOMER SERVICE: 1-612-531-0082

NAME \_\_\_\_\_  
 ADDRESS \_\_\_\_\_  
 CITY \_\_\_\_\_ ST \_\_\_\_\_ ZIP \_\_\_\_\_  
 PHONE \_\_\_\_\_

CARD NO. \_\_\_\_\_ EXP. DATE \_\_\_\_\_ SIGNATURE \_\_\_\_\_

Send To: DAMARK INTERNATIONAL, INC., 7101 Winnetka Ave. N., Minneapolis, MN 55428-1619

DELIVERY TO 48 U.S. CONTINENTAL STATES ONLY



Check/Money Order

SUB TOTAL

Total S/H/I

GRAND TOTAL

B-2405

Copyright 1990, DAMARK International, Inc. All rights reserved.

DECEMBER 1990



# No other training— anywhere—shows you service computers

Only NRI walks you through the step-by-step assembly of a powerful AT-compatible computer system you keep—giving you the hands-on experience you need to work with, troubleshoot, and service all of today's most widely used computer systems. With NRI at-home training, you get everything you need to start a money-making career, even a computer service business of your own.

No doubt about it. The best way to learn to service computers is to actually *build* a state-of-the-art computer from the keyboard on up. As you put the machine together, performing key tests and demonstrations at each stage of assembly, you see for yourself how each part of it works, what can go wrong, and how you can fix it.

Only NRI, the leader in career-building electronics training for more than 75 years, gives you such practical, real-world computer servicing experience. Indeed, no other training—in school, on the job, *anywhere*—shows you how to troubleshoot and service computers like NRI.

**You get in-demand computer skills as you train with your own AT-compatible computer system—now with 20 meg hard drive and 1 meg RAM**

With NRI's exclusive hands-on training, you actually build and keep the powerful new AT-compatible West Coast 1010 ES computer, complete with 1 meg RAM and 20 meg hard disk drive.

You start by assembling and testing the "intelligent" keyboard, move on to test the circuitry on the main logic board, install the power supply and 5-1/4" floppy disk drive,

**NEW!**

Now includes AT-compatible computer with 1 meg RAM and 20 meg hard drive!

then interface your high-resolution monitor. But that's not all.

**Only NRI gives you a top-rated micro with complete training built into the assembly process**

Your NRI hands-on training continues as you install the powerful 20 megabyte hard disk drive—today's most-wanted computer peripheral—included in your course to dramatically increase your computer's data storage capacity while giving you lightning-quick data access.

Having fully assembled your West Coast 1010 ES, you take it through a complete series of diagnostic tests, mastering professional computer servicing techniques as you take command of the full power of your computer's high-speed 80286 microprocessor.

In no time at all, you have the confidence and the know-how to work with, troubleshoot, and service every computer on the market today. Indeed, you have what it takes to step into a full-time,

**HARD DISK DRIVE**  
20 megabyte hard disk drive you install internally for greater disk storage capacity and data access speed.

**AT-COMPATIBLE COMPUTER**  
80286 CPU (12 MHz clock, 0 wait states), 1 meg RAM (expandable to 4 meg), 1.2 meg high-density floppy disk drive.

**DIGITAL MULTIMETER**  
Professional test instrument for quick and easy circuit measurements.

**LESSONS**  
Clearcut, illustrated texts build your understanding of computers step by step.

**SOFTWARE**  
Including MS-DOS, GW-BASIC, word processing, database, and spreadsheet programs.

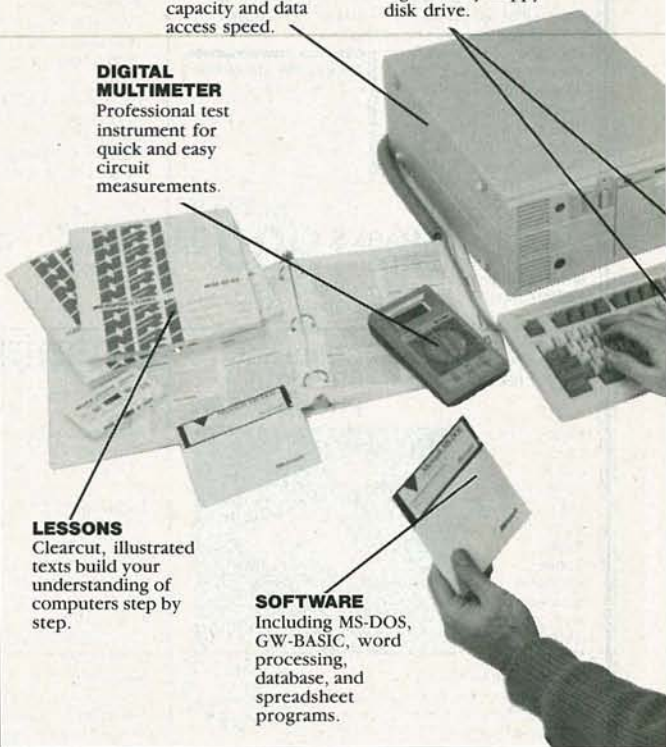

money-making career as an industry technician, even start a computer service business of your own.

**Voice synthesis training adds an exciting new dimension to your computer skills**

Now NRI even includes innovative hands-on training in voice synthesis, one of today's most exciting and widely applied new developments in computer technology.

You now train with and keep a full-featured 8-bit D/A converter that attaches in-line with your computer's parallel printer port.

**NEW!**



# in school, on the job, how to troubleshoot and like NRI

## MONITOR

High-resolution, nonglare, 12" TTL monochrome monitor with tilt and swivel base.

## TECHNICAL MANUALS

You get "inside" your Packard Bell computer system with exclusive NRI Training Kit Manuals plus technical specs direct from the manufacturer.

## DISCOVERY LAB

Complete breadboarding system to let you design and modify circuits, diagnose and repair faults.

## DIGITAL LOGIC PROBE

Gives you first-hand experience analyzing digital circuit operation.

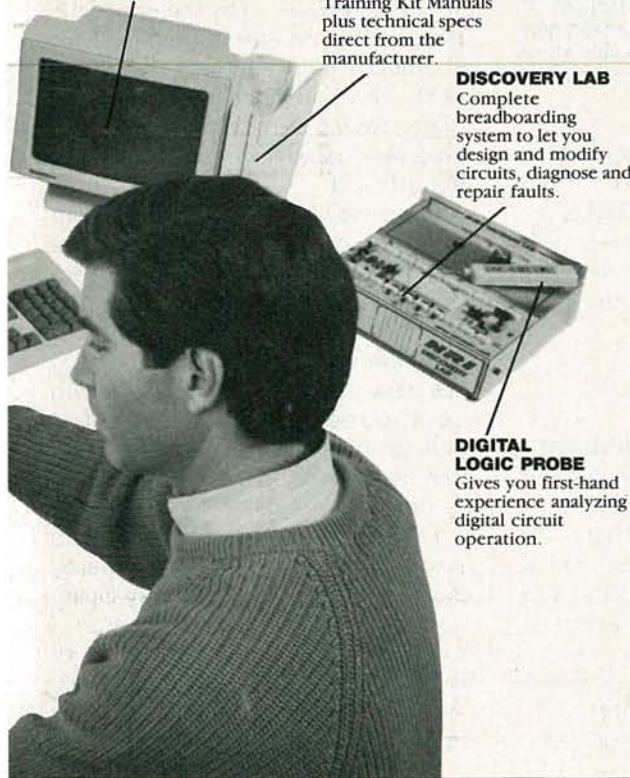

one more way NRI gives you the confidence-building experience you need to feel at home with the latest advances in computer technology.

## No experience needed, NRI builds it in

You need no previous experience in computers or electronics to succeed with NRI. You start with the basics, following easy-to-read instructions and diagrams, moving step by step from the fundamentals of electronics to sophisticated computer servicing techniques.

With NRI's unique Discovery Learning Method, you're sure to get the kind of practical hands-on experience that will make you fully prepared to take

advantage of every opportunity in today's top-growth field of computer service.

With NRI, you learn at your own pace in your own home. No classroom pressures, no night school, no need to quit your present job until you're ready to make your move. And all throughout your training, you have the full support of your personal NRI instructor and the NRI technical staff.

## Your FREE NRI catalog tells more

Send today for your free full-color catalog describing every aspect of NRI's innovative computer training, as well as hands-on training in robotics, video/audio servicing, telecommunications, electronic music technology, and other growing high-tech career fields.

If the coupon is missing, write to NRI School of Electronics, McGraw-Hill Continuing Education Center, 4401 Connecticut Avenue, NW, Washington, DC 20008.

AT is a registered trademark of International Business Machines Corporation

Using your D/A converter along with the exclusive text-to-speech software also included, you explore the fascinating technology behind both digitized and synthesized computer speech.

You discover how you can use your computer to access and play back a variety of prerecorded sounds... you see how to add speech and sound effects to programs written in BASIC, C, Pascal, and others... you even learn how to produce high-quality speech directly from your own original printed text.

NRI's exclusive new hands-on training in voice synthesis is just

## NRI

**School of Electronics**

McGraw-Hill Continuing Education Center  
4401 Connecticut Avenue, NW  
Washington, DC 20008

For career courses approved under GI Bill

check for details

**CHECK ONE FREE CATALOG ONLY**

<p><input type="checkbox"/> <b>Computers and Microprocessors</b></p> <p><input type="checkbox"/> Robotics</p> <p><input type="checkbox"/> TV/Video/Audio Servicing</p> <p><input type="checkbox"/> Computer Programming</p>	<p><input type="checkbox"/> Security Electronics</p> <p><input type="checkbox"/> Electronic Music Technology</p> <p><input type="checkbox"/> Basic Electronics</p> <p><input type="checkbox"/> Telecommunications</p>
---	---

Name \_\_\_\_\_ (Please Print) \_\_\_\_\_ Age \_\_\_\_\_

Address \_\_\_\_\_

City/State/Zip \_\_\_\_\_

Accredited Member, National Home Study Council

3-120



Many AM stations used standard telephone lines, which have upper limits of 5 kHz, to send audio from the studio to the transmitter. AM radios were built with narrow bandwidth IF filters to minimize interference. Even when high fidelity was introduced in the 1950's and 1960's, AM stations still used standard phone lines to link the studio with the transmitter. In the 1980's, almost all stations converted to high-fidelity 15-kHz telephone lines, but AM radios were still built with narrow bandwidths, due to the added expense entailed in a "wideband" option.

The standards proposed by the NRSC are intended as a compromise between interference and audio fidelity. Under the plan, AM stations will limit audio response to 10 kHz, thus limiting RF bandwidth to 20 kHz. The improvement in sound quality involves AM radios, which will be built with a "wideband" function that will receive the entire 10-kHz audio signal. As mentioned in the article, AM broadcasts will be pre-emphasized and "wideband" AM radios will have a corresponding de-emphasis curve, reducing noise while keeping audio response flat out to 10 kHz. Although not quite the equal of FM radio's 15-kHz audio response, wideband AM comes very close to matching FM's sound, and will dramatically improve the public's enjoyment of music broadcasts on AM radio.

Although I am only 16 years old, I have devoted much time to the study of radio, especially AM radio.

MATTHEW BAILEY  
Stone Mountain, GA

#### A VOICE OF EXPERIENCE

**Radio-Electronics** certainly fills a gap in the information world, not only for the novice who is anxiously pursuing the fascinating and useful study of electronics, but also for keeping more experienced readers posted. In addition, the magazine provides recreation in the form of construction projects, featuring unique and useful devices for us to build.

I have a suggestion to offer regarding the excellent series called "Introduction to Microwave Technology" by Joseph J. Carr. In the September issue, on page 69, it states that the three traditional methods for generating RF energy were spark gaps, Alexander alternators, and vacuum tubes. It appears that arc generators

were omitted from that category, although they were commonly found on board ships where the principle power source was 115 VDC. The arc signals were characterized by a much smoother wave band than spark sets, and were preferred by ship operators. They also were much more efficient than spark sets. (A sketch of such a device appears in Fig. 1.)

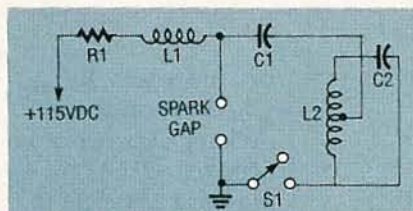

**FIG. 1—THIS CIRCUIT SHOWS an arc-generator, which was used on-board ships where the primary power source was 115 volts DC.**

Also on page 69 is a reference to using a Ford Model A ignition coil for a spark source of power. That is apparently an oversight, since the coils in demand were the vibrator-driven, type that were found on the Ford Model T.

FRANK J. BURRIS  
Fallbrook, CA

#### BUILD A RESISTANCE STANDARD

A "standard resistance" value is a necessity for a calibration laboratory. However, those certified standards can represent a sizable investment. If you are performing calibration services in the field as a secondary function, buying a "standard" can be difficult to justify. However, there is a way in which a "resistance standard" can be designed, fabricated, and certified for a nominal sum.

First, select the value of resistance that you need most, and then obtain a precision resistor of that value. That resistor should be a 1%-or-better tolerance component. Verify the *true* resistance of the device on a certified instrument that is at least ten times the accuracy of the resistor. That reading, taken between 72°F and 78°F, becomes the "certified value."

For example, I made a 1.62-kilohm resistor standard. I used a Dale 50-watt, 1%, wire-wound resistor as a "standard" value, and verified its true value with a 4½-digit DMM certified to have a 0.1% ± 2 LSD (least significant digit) error factor on the 0–2-kilohm range. The test leads were "zeroed" to eliminate their resis-

tance from influencing the readings. The ambient temperature on the surface of the component was verified to be 75°F. I made a series of 10 individual resistance measurements at 10-minute intervals, which prevented the component's value from changing due to internal heating caused by current from the measuring instrument flowing through the resistor. That change could be 1–2 ohms in a less expensive resistor but, since we are building a "certified standard," the marked value should be as accurate as possible. The ten readings were identical: The resistor proved to have an value of 1617 ohms. That is within the 1% tolerance specified.

The value derived by the use of the precision ohmmeter is the "true" or "certified" resistance of the component. The "nominal" value is 1620 ohms. Now that the numerical values have been established, we can package the unit.

Because it is a "traveling standard" we cannot always control the environment in which it will be used. We must provide a thermal mass to surround the resistor, and thereby act as a temperature stabilizer. Encasing the resistor in a thermal insulating compound prevents a sudden change of environmental temperature from affecting the measured value of the resistor.

I soldered two #16 insulated leads soldered to the resistor, and lowered it into a mold cavity (an empty Spam can sprayed with mold release). I placed the resistor in the center of the cavity and used a casting resin to fill the mold. The resin took two hours to set and 24 hours to cure.

Once the casting was removed from the mold, I repeated the initial resistance readings to ensure that the value of the resistor had remained constant. After performing the second resistance verification, I drilled two mounting holes through the casting. I bolted the casting into a small cabinet and sealed the enclosure with rivets. My new traveling resistance "standard" is marked:

"RESISTANCE STANDARD."

"NOMINAL VALUE—1.62K @ 1%"

"CERTIFIED VALUE—1,617 OHMS @ .185%"

"(Certified in thermal isolation mass at 75°F)"

CHARLES H. STURKEY  
Newhall, CT



# Welcome to. . .

# SCIENCE **PROBE!**<sup>®</sup>

The Amateur Scientist's Journal

Embark on an irresistible new journey into the realm of mystery, challenge, and exploration! The perfect magazine for the budding scientist, the serious amateur, the professional who would like to relax, and those who simply want to gaze at the stars.

Articles to appear in early issues of **SCIENCE PROBE!** are:

**LIGHTNING—CAPTURE IT ON FILM**  
**MONITORING ULTRAVIOLET FROM THE SUN**  
**MOBILE-MOUNT EXPERIMENTAL WIND TUNNEL**  
**CHECKING OUT ACID RAIN**  
**AERIAL PHOTOGRAPHY FROM KITES AND BALLOONS**  
**MINIATURE TRACKING TRANSMITTER**  
**KILLER BEE IDENTIFICATION**  
**HOW TO OBTAIN ANIMAL EYESHINE PHOTOGRAPHS**

If you're fascinated by science in all its many forms, if you are compelled to experiment and explore, then **SCIENCE PROBE!** is your kind of magazine!

## SCIENCE PROBE!

7 REM1

500-B Bi-County Boulevard  
Farmingdale, NY 11735

Please forward my Premier Edition of **SCIENCE PROBE!** as soon as it comes off the press. I am enclosing \$3.50-U.S.A. (\$3.95-Canada) plus \$1.00 for shipping and handling. Better still, please enroll me as a charter-member subscriber and send the next four (4) quarterly issues of *Science Probe*. I am enclosing \$9.95-U.S.A. (Canada: \$14.95 U.S.A. Funds)

Premier Edition only     First Four Issues (1 Year)  
Offers valid in the U.S.A. and Canada only. No foreign orders.

Name \_\_\_\_\_

Address \_\_\_\_\_

City \_\_\_\_\_ State \_\_\_\_\_ ZIP \_\_\_\_\_

All Orders payable in U.S.A. Funds only.

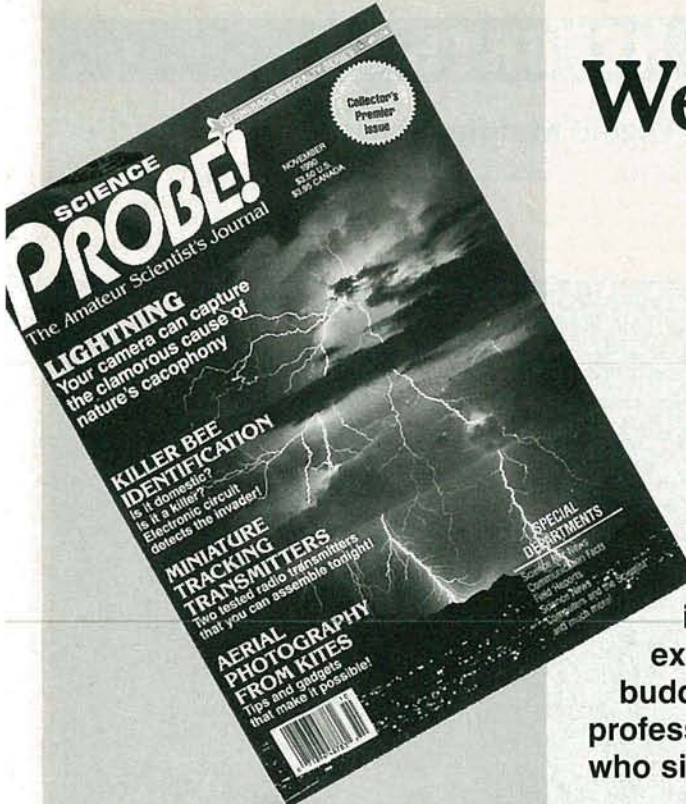

**SCIENCE PROBE!** — the *only* magazine devoted entirely to Amateur Scientists! If you are fascinated by science in all its many forms . . . if you can't stay away from a microscope, telescope, calipers, or test tube — we invite you to share the wonders in every issue of **SCIENCE PROBE!** You will join a community of Amateur and Student Scientists who enthusiastically seek scientific knowledge or follow scientific pursuits for their own sakes and not merely as a profession.

Obtain your personal *premier* edition of **SCIENCE PROBE!** by visiting a quality Newsstand, Convenience Store, or Supermarket this Fall or by reserving your personal copy through the mail by completing the coupon below.

From the very first issue of **SCIENCE PROBE!** you will be involved in a world of scientific facts, experiments, and studies pursued by amateur scientists who are university students, inventors, academicians, engineers, or office workers, salesmen, farmers—whose *quest* is to probe into the mysteries of science and reveal them to all.

Plan to become a **SCIENCE PROBE!** reader!

ON SALE AT QUALITY NEWSSTANDS, CONVENIENCE STORES AND SUPERMARKETS  
STARTING SEPTEMBER 13, 1990 — \$3.50-U.S.A. — \$3.95-Canada



# EQUIPMENT REPORTS

## Micronta's Voice Meter Digital Multitester

Using a digital multimeter isn't a difficult thing to do—or at least it shouldn't be. On a benchtop, that may be true. But in the real world of field measurements, using a multimeter can often try your patience—and your balance. Some of us have not-too-fond memories of measurements made on top of a ladder or catwalk, with half of our bodies reaching for the test points and the other half simultaneously stretching toward the meter to read its display. Others can relate to making under-dash automotive measurements where it's difficult to get your head positioned to see where you put the multimeter probes, let alone see the display.

Of course, multimeter manufacturers are more than happy to find solutions to the problems that their users encounter. We've seen several techniques that are used to freeze the display and hold a reading of interest. While they work well, and are a perfect solution for many situations, they all share one feature that is a failing in other situations: You have to look at the display to determine the reading.

Radio Shack (700 One Tandy Center, Fort Worth Texas 76102, and more than 7000 locations nationwide) has come up with a different solution: their Micronta *Voice Meter*. At the push of a probe-mounted button, the meter announces the measurement in a clear voice.

The *Voice Meter* doesn't look much different from many other digital multimeters. Its gray plastic case measures roughly  $7 \times 3 \times 1\frac{1}{4}$  inches, and features a  $3\frac{3}{4}$ -digit (3000-count) LCD readout, a power switch, and a six-position rotary function-selector. The six measurement functions are: DC volts, AC volts, diode check, resistance, DC current, and AC current.

DC and AC voltages are measured in five and four ranges respectively: 3000 volts with a resolution of 1 volt; 300 volts with a resolution of 0.1 volt; 30 volts with a resolution of 0.01 volt;

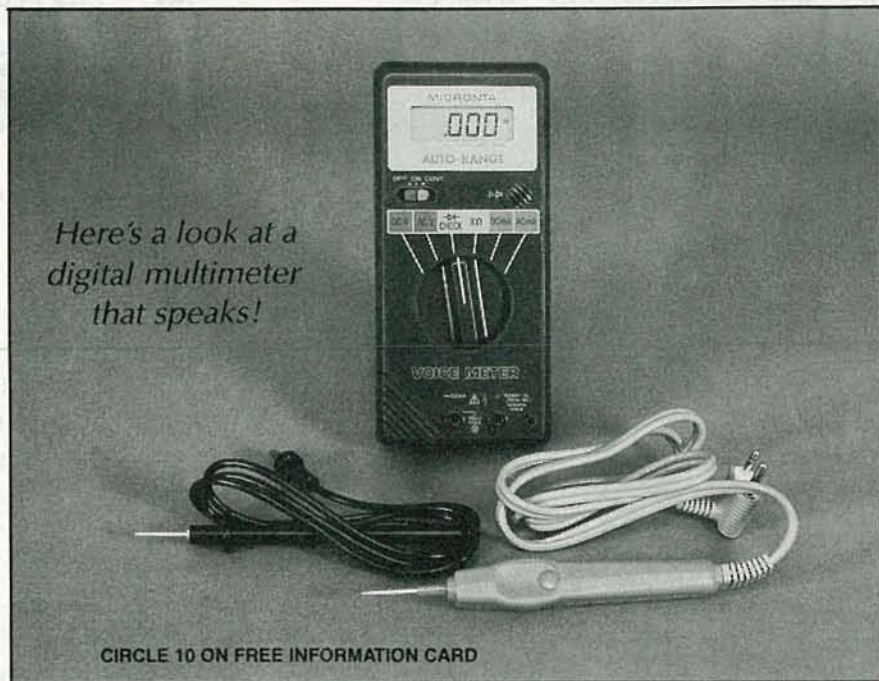

3 volts with a resolution of .001 volt; and (for DC only) 300 millivolts with a resolution of 0.1 mV.

Resistance is measured over six ranges, from 300 ohms through 30 megohms, with resolutions that range from 0.1 ohms in the 300-ohm range to 10K in the 30-megohm range. DC and AC current are measured in a single range of 300 milliamps, with a resolution of 0.1 milliamp.

Using the *Voice Meter* isn't significantly different from using standard multimeters. In fact, you don't have to use the voice feature if you choose not to. If you do choose the voice feature, getting the meter to speak is as simple as pressing a button on the positive probe. Unfortunately, if you need the voice capability, you must use the probe supplied with the meter.

While we initially found the voice to be a novelty, it quickly got on our nerves when we made repeated measurements. Despite the *Voice Meter's* clear, slow, easy-to-understand voice, we preferred simply glancing at the meter when making most measurements because it was

faster and quieter. (No volume control is provided on the meter). However, for our tests where we couldn't see the meter's face, the voice, of course, proved invaluable.

The *Voice Meter* is powered by four "AA" batteries. When the batteries are low, a BATT annunciator makes you aware of the fact. If you don't notice it, you will be prompted by an insistent "Replace batteries" announcement when you try to get a voice reading.

Our overall impression of Radio Shack's talking multitester was favorable. The only feature we didn't like was that the test probes don't offer sheathed banana plugs—an important safety consideration when you're making high-voltage measurements.

Although we liked the meter, we doubt it will find favor in professional circles. Most professional users—except those who really need voice capability—will want more features, ruggedness, and higher accuracy. However, most of those professionals will find the \$99.95 *Voice Meter* a perfect addition to their home workbench. **R-E**



# WITH CIE, THE WORLD OF ELECTRONICS CAN BE YOUR WORLD, TOO.

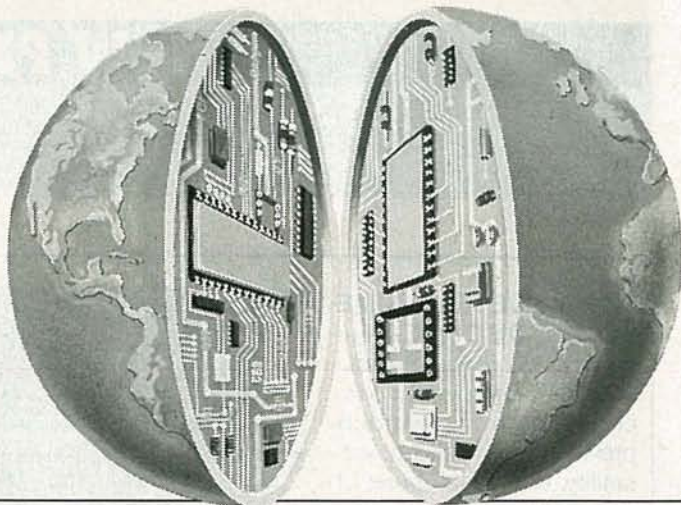

**L**ook at the world as it was 20 years ago and as it is today. Now, try to name another field that's grown faster in those 20 years than electronics. Everywhere you look, you'll find electronics in action. In industry, aerospace, business, medicine, science, government, communications—you name it. And as high technology grows, electronics will grow. Which means few other fields, if any, offer more career opportunities, more job security, more room for advancement—if you have the right skills.

## SPECIALISTS NEED SPECIALIZED TRAINING.

It stands to reason that you learn anything best from a specialist, and CIE is the largest independent home study school specializing exclusively in electronics, with a record that speaks for itself. According to a recent survey, 92% of CIE graduates are employed in electronics or a closely related field. When you're investing your time and money, you deserve results like that.

## INDEPENDENT STUDY BACKED BY PERSONAL ATTENTION.

We believe in independent study because it puts you in a classroom of one. So you can study where and when you want. At your pace, not somebody else's. And with over 50 years of experience, we've developed proven programs to give you the support

such study demands. Programs that give you the theory you need backed with practical experience using some of the most sophisticated electronics tools available anywhere, including our Microprocessor Training Laboratory with 4K of random access memory. Of course, if you ever have a question or problem, our instructors are only a phone call away.

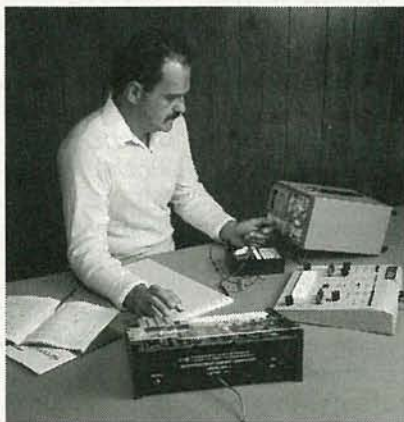

## START WHERE YOU WANT, GO AS FAR AS YOU WANT.

CIE's broad range of entry, intermediate, and advanced level courses in a variety of career areas gives you many options. Start with the Career Course that best suits your talents and interests and go as far as you want—all the way, if you wish, to your Associate in Applied Science Degree in Electronics Engineering Technology. But wherever you start, the time to start is **now**. Simply use the coupon below to send for your FREE CIE catalog and complete package of career information. Or phone us, toll-free, at **1-800-321-2155** (in Ohio, 1-800-523-9109). Don't wait, ask for your free catalog now. After all, there's a whole world of electronics out there waiting for you.

# CIE

**Cleveland Institute of Electronics, Inc.**  
1776 East 17th Street, Cleveland, Ohio 44114  
Member NHSC  
Accredited Member National Home Study Council

ARE-182

**CIE** **Cleveland Institute of Electronics, Inc.**  
1776 East 17th Street, Cleveland, Ohio 44114

**YES...** I want to learn from the specialists in electronics—CIE. Please send me my FREE CIE school catalog, including details about CIE's Associate Degree program, plus my FREE package of home study information.

Name (print): \_\_\_\_\_

Address: \_\_\_\_\_

City: \_\_\_\_\_ State: \_\_\_\_\_ Zip: \_\_\_\_\_

Age: \_\_\_\_\_ Area Code/Phone No.: \_\_\_\_\_ / \_\_\_\_\_

Check box for G.I. Bill bulletin on educational benefits:

Veteran  Active Duty

**MAIL  
TODAY!**



# NEW PRODUCTS

Use the Free Information Card for more details on these products.

## PORTABLE REAL-TIME OSCILLOSCOPE.

The model 2252 programmable 100-MHz-bandwidth oscilloscope from Tektronix provides the precision, versatility, and ease-of-use of an analog scope, plus the ability to record the displayed signal on paper at the push of a button. The fully automated oscilloscope ensures measurement accuracy with its integrated digital voltmeter, "Smart Cursors," and precision counter/timer. The scope also features four channels, automatic setup, and dual time bases. Fully programmable over the standard IEEE-488.2 interface bus, the instrument can be controlled remotely from a PC.

A unique sequential-sampling technique digitizes a repetitive signal for hardcopy output on an Epson-compatible printer. All displayed channels, scale factors, and active measurements can be transferred to the printer via a Centronics interface. Test results can be quickly documented, or unknown signals can be recorded for later review.

All oscilloscope functions, including instrument setup, signal acquisition,

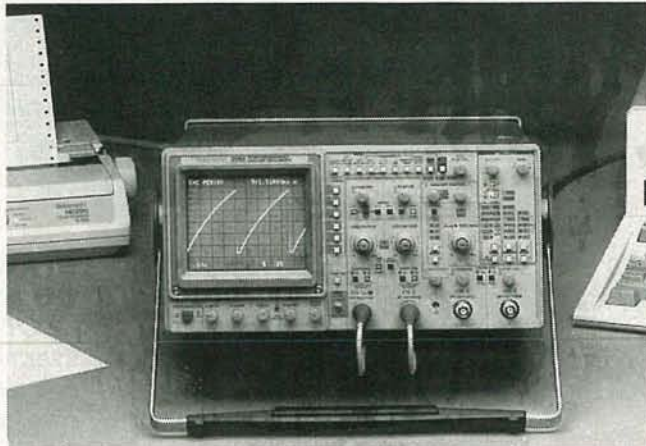

CIRCLE 16 ON FREE INFORMATION CARD

and measurement controls, are accessible over the standard GPIB. The interface and computer analysis make automated and repetitive testing applications easier and less time consuming than many other methods. The scope is supported by test-development software from Tektronix.

The 2252 provides a full complement of automatic measurements. The voltmeter includes "Smart Cursors," which automatically track changes in voltage measurements and visually indicates where measurements are being made on the waveform. The 200-MHz counter/timer delivers crystal-controlled, 10 parts per million

accuracy for timing measurements such as automatic rise/fall time and propagation delay calculations. All measurements are made on the real-time analog signal. With its time-averaging counter, the scope is capable of up to 10-picosecond timing resolution at any sweep speed. Voltage measurements made using the voltmeter have better than 10-bit vertical accuracy. Gated measurements can be made on any portion of the signal.

The 2252 real-time oscilloscope, including both Centronics and GPIB interfaces, has a list price of \$3,495.00—**Tektronix**, P.O. Box 1700, Beaverton, OR 97075; Tel: 1-800-426-2200.

The pen is easy to use. Normal writing pressure opens the tip and starts the flow of overcoat. Traces as narrow as  $\frac{1}{16}$  inch are possible, and the pen contains enough coating material—a polymer that is available in several colors and clear—to insulate and protect approximately 60 feet of exposed traces. The material dries in 5–10 minutes and can be heat cured at 50°C–100°C for enhanced performance. Maximum working temperature is 200°C. The wide temperature range permits both spot solder mask for in-line soldering operations and a durable overcoating for solder-mask repair of open traces and exposed connections after soldering. The overcoating is safe for gold, silver, copper, and solder alloys, and is flexible when cured.

The 3300 *Circuit Works Overcoat Pen* costs \$9.95 plus shipping (\$1.00 U.S. Mail or \$2.50 UPS)—**Planned Products**, 303 Potrero, Suite 53, Santa Cruz, CA 95060; Tel: 408-459-8088; Fax: 408-459-0426.

## AUTORANGING DIGITAL MULTIMETER.

Designed for convenient testing and troubleshooting, *B&K-Precision's* model 2701 autoranging DMM has a belt-clip and test-lead clips built into its case for hands-free use and safe storage of probes. The compact, hand-held multimeter allows single-handed operation in hard-to-reach locations. It can be used to test AC and DC voltage and current, as well

## SOLDER-MASK REPAIR PEN.

An easy way to insulate, protect, and repair circuit boards, components, and delicate electronics is provided by the 3300 *Circuit Works Overcoat Pen*. The pen applies a tough, conformal coating to insulate against shorting, arcing, and static discharge



CIRCLE 17 ON FREE INFORMATION CARD

while it protects against moisture, abrasion, chemicals and other environmental hazards. Particularly useful in the design, prototyping, and repair of PC boards, the overcoat pen improves the reliability and safety of modifications when used to repair solder masks.





CIRCLE 18 ON FREE INFORMATION CARD

as for resistance, diode, and continuity checks. The 2701 has a 3½-digit LCD. Its functions include auto-ranging, "High" and "Low" power ohms, and data hold. A 9-volt battery provides 800 hours of continuous operation.

The 2701 autoranging digital multimeter costs \$69.00.—**B&K-Precision**, Maxtec International Corp., 6470 West Cortland Street, Chicago, IL 60635; Tel: 312-889-1448.

**FREON-GAS ANTI-DUST SPRAY.** Containing no CFC's, *Dust-A-Way* from *Jensen Tools* removes dust, lint, and other foreign particles from delicate equipment with no risk to the ozone. Depressing the trigger valve on the 12-ounce can delivers a quick burst of dry, inert freon gas precisely where it is needed. The spray is recommended for use on electrical, electronic, optical, and delicate mechanical devices.

*Dust-A-Way* freon gas



CIRCLE 19 ON FREE INFORMATION CARD

spray costs \$7.95 for a 12-ounce can.—**Jensen Tools Inc.**, 7815 South 46th Street, Phoenix, AZ 85044.

**RACK-MOUNT LINE CONDITIONER.** Providing affordable, effective voltage regulation in a compact unit, the *Tripp Lite LCR-2400* rack-mount line conditioner is designed to meet the needs of recording studios, testing labs, and industrial settings where 19-inch racks are used. With a 2400-watt output (20 amps maximum) and 14 AC outlets, the *LCR-2400* can simultaneously run a wide variety of equipment, test instruments, or appliances. Various input voltages from 87 to 140 VAC are controlled to 120-VAC output within ANSI C84.1 specifications to protect equipment from brown-outs or over-volt-



CIRCLE 20 ON FREE INFORMATION CARD

ages. Built-in surge suppressors protect sensitive devices from spikes, line noise, and RFI/EMI interference. Two isolated filter bands prevent connected equipment from interacting with each other. The *LCR-2400* has a multi-color LED readout that indicates the level of line-input voltage and reacts to changes as they occur.

The *LCR-2400* rack-mount line conditioner has a suggested retail price of \$459.00.—**Tripp Lite**, 500 North Orleans, Chicago, IL 60610-4188; Tel: 312-329-1777; Fax: 312-644-6505.



### With The Market Proven VA62A Universal Video Analyzer™

Are you finding it tough to service today's hi-tech VCR and TV circuits? Successful video servicers have told us that, to them, the new technology meant lost profit and troubleshooting grief until they tried the VA62A's time tested, functional analyzing methods. "The VA62A cuts servicing time and increases profits . . ."

\*Based on a nationwide survey of users who reported an average time savings of 54% compared to their previous test equipment.

# Cut Your Video Servicing Time by 54%\*



**\$3,495 Patented**

You can prove it to yourself, in your shop, absolutely risk free—and share in the profits successful video servicing can bring. Call **1-800-SENCORE (736-2673)** and ask about our exclusive VA62A instrument evaluation program. Tech-Tape Video Preview and FREE full line color catalog are also available.

**SENCORE®**  
3200 Sencore Drive, Sioux Falls, SD 57107  
100% American Made

CIRCLE 194 ON FREE INFORMATION CARD





**An ETCHED  
circuit board  
from a  
Printed PAGE  
in just 3 Hours**

The ER-4 PHOTO ETCH KIT gives you the tools, materials and chemicals to make your own printed circuit boards. The patented Pos-Neg™ process copies artwork from magazines like this one without damaging the page. Use the circuit patterns, tapes and drafting film to make your own 1X artwork. Or try the Direct Etch™ system (also included), to make single circuit boards without artwork. The ER-4 is stocked by many electronic parts distributors, or order direct, postpaid.

ER-4 PHOTO ETCH KIT (NJ and CA residents add sales tax) ..... \$38.00  
**DATAK'S COMPLETE CATALOG** lists hundreds of printed circuit products and art patterns. Also contains dry transfer letter sheets and electronic title sets for professional looking control panels. **WRITE FOR IT NOW!**

**DATAK Corporation • 55 Freeport Blvd, Unit 23 •  
 Sparks, NV 89431**

CIRCLE 196 ON FREE INFORMATION CARD

## Professional Tool Case

**SPECIAL  
\$59.95**  
 Reg. \$80.00\*

**Makes  
a Great  
Holiday  
Gift!**

Model REIM5

- Two removable pallets hold over 60 tools
- Case top has built-in document holder
- Case bottom is partitioned into 3 areas

A handsome black case to organize and transport your valuable tools and instruments. This is the same quality case used by literally thousands of professional field engineers. Case is made of high impact polypropylene, and has snap-action key locks and a padded handle.

Size: 17½" x 12½" x 5".

Tools are not included.

Offer expires January 31, 1991.

**To order call:  
 1-800-225-5370**  
 In MA: (508) 682-2000  
**Same Day Shipment!**  
**Money Back Guarantee!**

Terms: Visa, MC, Amex;  
 PO's from qualified firms accepted.  
 Add \$5.50 for packing and delivery



## FREE CONTACT EAST CATALOG

Contains thousands of products for testing, repairing & assembling electronic equipment. To get your free catalog, call (508) 682-2000.

CIRCLE 55 ON FREE INFORMATION CARD

## LOGIC ANALYZERS.

Philips' PM 3580/PM 3585 family of logic analyzers feature quick set-up time—users need less than 30 minutes to get an instrument up and running. Pop-up menus and VGA graphics offer a simple interface for new users, and provide experienced users with short cuts for quick operation. Faster analysis is obtained by reducing state and timing measurements to one probe connection, requiring only one set-up to be learned, and providing fully-integrated state and timing triggering. All measurements are time tagged with up to 5-nanoseconds resolution.



CIRCLE 21 ON FREE  
INFORMATION CARD

The logic analyzers feature a unique dual-analyzer-per-pin architecture that allows both state data (relating to software functioning) and timing data (relating to hardware performance) to be acquired from the system simultaneously on up to 96 channels, using just a single set of probes. Performance specifications are 50-MHz state, up to 200-MHz timing, and 2 kilobytes of memory per channel. Windows allow the display of state and timing or two views of state or timing data.

Other features include a large, high-resolution screen, a video-output socket for connection to an external large-screen VGA monitor, and a parallel-printer port for hardcopy output. Also provided is an RS-232 serial port for diagnostic testing and future options, and BNC trigger

connectors for easy trigger of other instruments, or for external triggering of the logic analyzer from another instrument.

The PM 3580/PM 3585 family of logic analyzers ranges in price from \$4,250 for the PM 3580/30 with 32 channels of 50-MHz state recording and 32 channels of 100-MHz timing and 1K deep memory, to \$10,950 for the PM 3585/90 (pictured), which offers 96 channels of 50-MHz state and 96 channels of 200-MHz timing recording with 2K memory.—  
**John Fluke Mfg. Co., Inc.**, P.O. Box 9090, Everett, WA 98206; Tel: 800-44-FLUKE, ext. 77.

## DIGITAL SIGNAL PROCESSING BOARD.

Dalanco Spry's model 250 digital signal processing (DSP) board has analog and digital inputs and outputs for the PC/AT and bus-compatible microcomputers. The board is based on the 40-MHz Texas Instruments' TMS320C25 DSP, and can accommodate the faster TMS320C25-50, the EPROM-based TMS320E25, and the newer TMS320C26. The model 250 can be used in stand-alone mode in embedded systems when equipped with the TMS320E25. The DSP board provides data acquisition for eight single-ended channels at 12-bit resolution and a maximum 300-kHz sampling rate. Two analog-output channels are provided, as are a buffered digital I/O expansion connector and the serial (codec) interface of the TI DSP. The board can be populated with up to 64K words of zero-wait-state program RAM and up to 128 words of one-wait-state data RAM. The data RAM is simultaneously available to both the PC



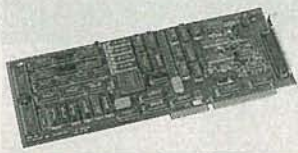

CIRCLE 22 ON FREE INFORMATION CARD

and the TMS320 DSP through the use of an on-board memory controller.

The model 250 features high throughput and is easily accommodated in multiple-board systems. PC-to-data RAM-transfer speeds may be as high as 3 megabytes per seconds. The maximum continuous throughput to disk is thus limited only by the capabilities of the host PC's disk system. Software that is bundled along with the model 250 includes assembler, debugger, FFT's, signal and spectrum display, digital filter examples, record and playback to and from disk, and a waveform editor.

The model 250 digital signal processing board is priced starting at \$1095 (40-MHz TMS320C25, 4K words of program RAM, and 32K words of data RAM).—**Dalanco Spry**, 89 Westland Avenue, Rochester, NY 14618; Tel: 716-473-3610.

**HANDSHAKING MODEM.** Offering full-duplex data transmission at rates of up to 19.2 kiloband and a bi-directional control signal—all over two twisted pairs—*Telebyte Technology's* model 204 *Handshaking Modem* can provide a "hardware handshake" for devices such as laser printers and various terminals.

The "handshake" is typically used when terminals are connected to a PBX switch, which uses the handshake to determine if the terminal is active or if its power has been turned

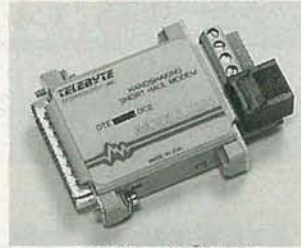

CIRCLE 23 ON FREE INFORMATION CARD

off. Housed in a small plastic case, the full-duplex modem measures only 2 x 2 3/4 x 3/4-inches.

The model 204 samples clear-to-send (pin 4), request-to-send (pin 5), and transmit data of the RS-232 serial interface, and derives its operating power from them—no battery or external power supply is required. The standard-data I/O occurs on pins 2 and 3 of the RS-232 connector. The control signal uses DTR (data terminal ready) as the handshake input and DCD (data carrier detect) as the hand-

shake output. The input and output are switchable, to accommodate connection of the modem to either a DTE or DCE device. The control signal input also controls the data flow from the modem. Data can be transmitted when the control signal is high. The modem requires no separate power inputs.

Data transmission between modems uses differential baseband signaling techniques, and common-mode signal rejection capability is greater than 20 volts. Those features are there to allow error-free operation in all kinds of noisy environments.

The model 204 costs \$89.00 in unit quantity and \$68.00 in quantities of 100.—**Telebyte Technology Inc.**, 270 East Pulaski Road, Greenlawn, NY 11740; Tel: 1-800-835-3298 or 516-423-3232; Fax: 516-385-8184. **R-E**

# The Ultimate in Home Control

## Heath®

Just imagine, one press of a button and you can turn off your stereo, turn on your TV and VCR, start a videotape, and dim the lights. The best part is you've done it all from your favorite chair.

The One For All remote Whole House Controller, Command Center and Lamp Module make it all possible.

Installation is a snap. The remote Whole House Controller operates virtually any infrared-controlled device, and when used with the Command Center can control lights throughout your house. Just point the remote Whole House Controller at the Command Center and press a button. You've got home control.

Expand your reach to additional lights and small appliances with other X-10 modules available from the Heath Catalog. Call 1-800-44-HEATH for your FREE copy.

**Order Today**  
**\$119.95\***

Use Order Code 601-044 when ordering the One For All System URS-6000.

**Call Toll-Free**  
**1-800-253-0570**

\* Price does not include shipping and handling, or applicable sales tax for MI and CA deliveries



© 1990 Heath Company, Benton Harbor, MI



Lamp Module    Controller    Command Center



CIRCLE 86 ON FREE INFORMATION CARD



## NEW LIT

Use The Free Information Card for fast response.

**ELECTROMECHANICAL DESIGN HANDBOOK;** by Ronald A. Walsh. TPR, Division of TAB Books Inc., Blue Ridge Summit, PA 17294-0850; Tel. 1-800-233-1128; hardcover; \$49.50.

The fields of electrical and mechanical engineering are closely linked in the design and development of today's manufactured products. This book fills an important gap in the libraries of engineers and designers whose work requires them to cross the boundaries between electrical and mechanical design. Including information about both disciplines, this well-organized book provides practical product-design data, working procedures, and formulas in one comprehensive volume. The broad range of subject matter covered includes the following: spring design; standard fasteners and bonding methods; prototype construction; product liability, testing, and patents; basic pneumatic, hydraulic, air-handling, and heat equations and their uses; sheet-metal design and layout; and the selection of bearings and gears. In-depth treatments of frequently encountered topics are also presented, including descriptive geometry statics and dynamics, the fundamentals of circuit design, electronic components, fabrication techniques, drives, and linkages and mechanisms. The book provides real-world examples and more than 500 detailed illustrations. The emphasis throughout the pages of



CIRCLE 10 ON FREE INFORMATION CARD

this handbook is on the practical design data needed in the day-to-day development of parts, mechanisms, and assemblies.

**'90/'91 CATALOG;** from Parts Express International Inc., 340 East First Street, Dayton, OH 45402; Tel: 513-222-0173; Fax: 513-222-4644; free.

Packed full of electronic parts and accessories, this catalog will interest both professionals and hobbyists. In its pages are capacitors; resistors; speakers and accessories; semiconductors; connectors; wire and cable; TV, CATV, and VCR repair parts; technical books and schematics; alarm equipment;



CIRCLE 11 ON FREE INFORMATION CARD

tools; chemicals; switches; and computer accessories. (Customers outside the U.S. and its territories must send \$5.00 for postage to receive the Parts Express catalog.)

**MONITOR POCKET GUIDE;** from Display Technologies, Inc., 1355 Holmes Road, Elgin, IL 60123; Tel. 708-931-2100; Fax: 708-931-2120; free.

This 4 x 9-inch brochure contains complete information on 7½- and 9-inch color monitors and monochrome models that range in size from 5 to 21 inches. The guide includes easy-to-reference tabbed cards that list specifications such as CRT size, video and power inputs, horizontal



CIRCLE 12 ON FREE INFORMATION CARD

and vertical frequencies, and bandwidth, for each of Display Technology's products. Available options are also listed, and mechanical drawings of the products appear on the back of the cards. Highlighted in the brochure are the Color Pix.L monitors, which feature Sony Trinitron CRT technology. In addition, the pocket guide contains a listing of sales offices and guidelines for choosing a monitor supplier.

**BROADCAST DATA SYSTEMS: TELETEXT AND RDS;** by Peter L. Mothersole and Norman W. White. Butterworths, 80 Montvale Avenue, Stoneham, MA 02180; Tel: 617-438-8464; hardcover; \$39.95.

Data transmission over TV and radio channels—commonly called teletext

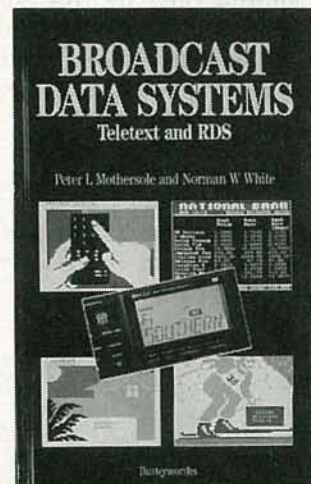

CIRCLE 13 ON FREE INFORMATION CARD

and Radio Data System (RDS), respectively—are becoming important aspects of modern broadcasting technology. This book covers both established television and radio practices and the computer technology that is used in the teletext and RDS systems. Background information concerning the development of teletext is presented, along with the data-signal format and coding methods used. The various components required to form a complete system are described. Other chapters cover such subjects as preparing and recording subtitles, the networking of teletext data signals and regional ser-



vice requirements, teletext decoders, and the re-transmission of decoded teletext signals as a video signal. The measuring techniques required to maintain broadcast networks and to test decoders for both teletext reception and data distribution are described. The recent development of RDS, which allows digital data to be combined with a VHF radio signal, is discussed. The necessary techniques for both coding and decoding the signal are explained, and various applications are detailed—including the use of RDS to provide a local traffic-information service by interrupting network programming.

**LOW-COST HIGH-QUALITY OSCILLOSCOPE PROBES;** from Avex Probes Inc. (API), 1683 Winchester Road, P.O. Box 1026, Bensalem, PA 19020; Tel: 1-800-87-PROBE; Fax: 215-638-9108; free.

A variety of monolithic and modular oscilloscope probes are featured in this six-page brochure. Product descriptions are accompanied by photographs and specifications, and a handy cross-reference chart is included. Also highlighted in the catalog are a wide variety of probe accessories, and a 40-piece connector/adapter kit.



CIRCLE 14 ON FREE INFORMATION CARD

**GLOSSBRENNER'S COMPLETE HARD DISK HANDBOOK;** by Alfred Glossbrenner and Nick Anis. Dvorak Osborne McGraw-Hill, 2600 Tenth Street, Berkeley, CA 94710; softcover with diskettes; \$39.95.

This encyclopedic volume is filled with clearly presented information on hard-disk drives for computer users of all levels of expertise. The book includes practical advice and convenient tips about selecting, buying, and installing a hard disk; loading and organizing the hard disk for

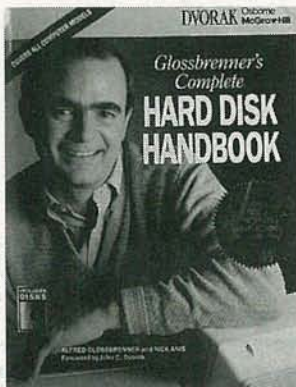

CIRCLE 15 ON FREE INFORMATION CARD

maximum efficiency; restoration and recovery techniques; networking; and special formatting procedures. The first section of the book is dedicated to a "Quick-Start Guide" to get readers painlessly started using their hard-disk drives. The ins and outs of using DOS are explained in detail. The book describes how to avoid problems by following guidelines for maintenance, security, back-up techniques, and file recovery. Included with the book are two 5½-inch floppy disks that contain nearly 50 programs, including tutorials, software tools, and utilities. Money-saving coupons for many items are also provided in the back of the book. R-E

# CABLE - TV

## SIGNAL REMOVERS

- FOR ELIMINATION OF SEVERE INTERFERENCE
- FOR "CENSORING" OF ADULT BROADCASTS



FOR FULL DESCRIPTION OF USES ask for our free brochure

- ATTENUATION - 45 dB TYPICAL
- BANDWIDTH - 4 MHz AT 5 dB POINTS
- INSERTION LOSS - 2 dB

MODEL	TUNING RANGE	FOR CHANNELS	PASSBAND	PRICE	SHIPPING
23H	50-66 MHz	2.3 (or 6 meter ham)	50-300 MHz	\$30	NO SHIPPING or C.O.D. CHARGES
46FM	66-108 MHz	4.5.6 (or any FM)	50-300 MHz	\$30	
1417	120-144 MHz	14(A) 15(B) 16 (C) 17(D)	50-400 MHz	\$30	
1822	144-174 MHz	18(E) 19(F) 20(G) 21(H) 22 (I)	50-400 MHz	\$30	
713	174-216 MHz	7.8.9.10.11.12.13	50-400 MHz	\$30	

3 for \$75 - 10 for \$200 - mix or match

CALL TOLL FREE FOR C.O.D. OR SEND CHECK TO ORDER  
FAST DELIVERY  
30 DAY MONEY BACK GUARANTEE (3 FILTER LIMIT)

**Star Circuits**

P. O. Box 94917  
Las Vegas, NV 89193-4917

1-800-433-6319

## SWITCHABLE SCOPE PROBE



ONLY \$35

- 3 POSITION SWITCH 1X, 10X, REF.
- COMPENSATION FOR ALL SCOPES
- SNAP ON ROTATING GROUND
- SATISFACTION GUARANTEED
- REPLACEABLE TIP

\$89 KIT

TOLL FREE (800) 772-1519

FREE CATALOG OF TEST LEAD KITS & ACCESSORIES

CALL FOR NEAREST DISTRIBUTOR

MODEL	ATTEN.	BW MHz AT-3DB	LENGTH FT. M	RISETIME ns	LOADING PF MΩ	PRICE
4101	Switchable 1x/10x/R	15/200	4 1.2	25/1.4	65/14 1/10	35.00
4103	1x	25	4 1.2	1.4	45 1	30.00
4104	10X	200	4 1.2	1.4	14 10	33.00
4110	100x	250	4 1.2	1.4	7 100	49.00
4115	MASTER KIT	INCL. 1EA. 4101, 4103, & 4104				89.00

CIRCLE 179 ON FREE INFORMATION CARD

PROBE MASTER  
4898 RONSON CT.,  
SAN DIEGO, CA 92111  
FAX (619) 560-7354



# RADIO SHACK PARTS PLACE<sup>SM</sup>

WHERE SANTA STOCKS HIS WORKSHOP!



## PARTS HOTLINE

Radio Shack has a huge selection of popular electronic components. Plus, we can special-order 10,000 items from our warehouse—ICs, tubes, semiconductors, phono cartridges and styli, even SAMS® manuals. Service is fast and there's no minimum order or postage charge.



## BATTERY HOTLINE

In addition to our large in-store stock, we can now supply almost any currently manufactured consumer-type battery—for cordless phones, computer memory, camcorders, transceivers, pagers and more. Service is fast and there are no postage or handling charges.



**Studfinder.** Ends guessing, easy to use! Senses changes in wall density to find wooden studs fast—also wires, conduit, pipes. Battery extra. #64-2825 ..... 19.95



**Super Calculator!** The EC-4035 makes electronics math a snap. Displays and computes with electrical units—V, A, mA, mW. 110 functions. #65-983 ..... 39.95

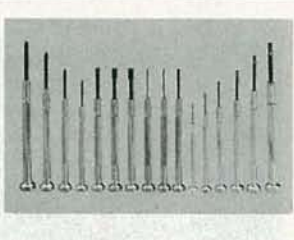

**16-Piece Precision Tool Kit.** Top-quality jeweler's-type phillips, blade and nutdrivers plus hex keys and a torque bar. Fitted molded case. #64-1961 ..... 10.95



**100-Watt Soldering Gun.** Pull the trigger for full temperature in seconds. Built-in light. The comfort-molded handle stays cool. UL listed AC. #64-2193 ..... 10.95



**NEW! Semiconductor "Sub" Book.** Our 1991 edition lists over 95,000 types and the Radio Shack replacements. #276-4014 ..... 3.99

**Getting Started in Electronics.** By Forrest Mims III. The perfect introduction to project building. 128 pages. #276-5003 ..... 2.49

## ELECTRONICS STOCKING STUFFERS!



**Engineer's Mini-Notebook Series.** By Forrest Mims III. Great gifts! Project ideas and useful data in Mims' famous, friendly style—big diagrams, handlettered text. With tips and suggestions for further experiments.

- NEW! Science Projects.** #276-5018 .. 1.49
- Timer ICs.** 555/556 ICs. #276-5010 ... 99¢
- Op Amp ICs.** #276-5011 ..... 1.49
- Optoelectronics.** #276-5012 ..... 1.49
- Basic Circuits.** #276-5013 ..... 1.49
- Digital Logic Circuits.** #276-5014 ... 1.49
- Communications Projects.** #276-5015, 1.49
- Formulas and Tables.** #276-5016 ... 1.49
- Schematic Symbols.** #276-5017 ..... 1.49

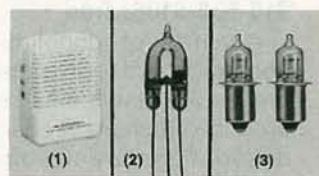

- (1) **Mini Audio Amp/Speaker.** Ideal testbench amp, also great for computer voice/music synthesis. Battery extra. #277-1008 ..... 11.95
- (2) **Long-Life Xenon Strobe Tube.** With data. #272-1145 ..... 3.29
- (3) **Halogen Flashlight and Lantern Bulbs.** HPR50. 6-volt. #272-1189, HPR52. 3V. #272-1190 .. Each 3.95



**Pocket-Size Digital Multimeter With Autoranging.** Super gift for anyone working with electronics. This tester folds, with its probes, to fit a shirt pocket. Features easy-to-read LCD display, continuity sounder. Measures to 400 volts AC/DC, 2 megohms resistance. 4 1/4 x 2 1/8 x 5/16". #22-171 ..... 39.95

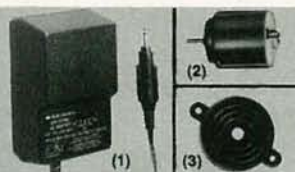

- (1) **Universal AC Adapter.** 3, 4.5, 6, 7.5 or 9VDC output. With 6-piece Adaptaplug® set. #273-1650 ..... 12.95
- (2) **1 1/2-3VDC Motor.** About 1 1/2" long. #273-223 ..... 99¢
- (3) **DC Pulsing Buzzer.** Extra loud! #273-066 ..... 4.29

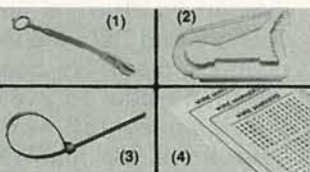

- (1) **NEW! Reusable Cable Ties.** #278-1622 ..... Pkg. of 10/4.99
- (2) **"Universal" Cable Clips.** #278-1647 ..... Pkg. 10/2.79
- (3) **NEW! In/Outdoor Wire Ties.** #278-1652 ..... Pkg. of 30/2.99
- (4) **Markers.** 630 stick-on letters. #278-1650 ..... Set/1.79

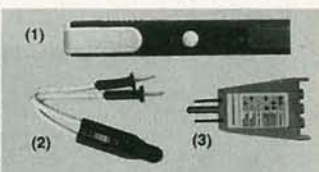

- (1) **NEW! AC Sensor.** Indicates presence of 70 to 440VAC without direct electrical connection. Safety first! #22-103 ..... 9.95
- (2) **NEW! Circuit Tester.** 90-300V AC/DC. #22-102 ..... 1.99
- (3) **AC Outlet Fault-Finder.** 3-prong for grounded outlets. #22-101 .. 5.95

Since 1921 Radio Shack has been the place to obtain up-to-date electronic parts as well as quality tools, test equipment and accessories at low prices. Over 7000 locations to serve you—NOBODY COMPARES

Prices apply at participating Radio Shack stores and dealers. Radio Shack is a division of Tandy Corporation

**Radio Shack**  
AMERICA'S TECHNOLOGY STORE

CIRCLE 78 ON FREE INFORMATION CARD



THE INTERSIL ICM7216 frequency-counter IC's (models A-D) have an impressive array of functions. All have a high-frequency oscillator, decade time-base counter, 8-decade data counter and latches, 7-segment decoder, digit multiplexers, and 8-digit multiplexed LED-display drivers.

There are four models; the 7216A and 7216B are universal counters, capable of measuring input frequency, oscillator frequency, frequency ratio, period, and time interval, and can perform unit counting. The frequency counter discussed here uses the 7216C with a common-anode display (the 7216D is similar). It'll become one of the most versatile pieces of test equipment on your bench, and simply fun to use. You can build it for about \$80.

#### Circuit description

Figure 1 shows the pinouts for all four 7216 versions; the 7216A/B use two inputs for measurements like the ratio of two fre-

# BUILD THIS BENCHTOP FREQUENCY COUNTER

**Add frequency-measurement capabilities to your workbench with this inexpensive counter.**

CARL BERGQUIST

quencies. The 7216C/D use single inputs, but have external decimal point (EX DP INPUT) inputs (pin 13), and MEASUREMENT IN PROGRESS outputs (pin 2).

The frequency counter schematic is shown in Fig. 2. IC2 decade counts the input frequency, stores the result in latches, drives an 8-digit multiplexed LED display, and blanks all leading zeros. While the internal os-

cillator normally uses 10-MHz crystal XTAL1, an external source can go on J3 to pin 24 of IC3 (EXT OSC INPUT). Some other 7216C features are display blanking, measurement holding, and display test-reset.

Since IC2 is designed for a maximum reading of 10 MHz, IC1, a 7490 decade counter, expands the range to 100 MHz by connecting pin 1 (B<sub>IN</sub>) to pin 12 (Q<sub>A</sub>) for the maximum count period. Pin 8 (Q<sub>C</sub>) is tied to pin 28 (INPUT A) of IC2 for measurement. For more expansion, IC3, a CD4017 decade counter, is an adjustable divide-by-N.

As mentioned earlier, there are four ranges, and operation is possible with or without IC3. When S8 is set to OUT, IC3 isn't used, and the display reads 1:1, showing the actual undivided frequency of the input on J1 or J2 in kHz. Obviously, if the frequency of the input goes below the nominal minimum possible for any given range, the display will read zero.





## PARTS LIST

All resistors are 1/4-watt, 5%, unless otherwise noted.

R1—3300 ohms  
 R2—100,000 ohms  
 R3, R5—10,000 ohms  
 R4—22 megohms  
 R6—22,000 ohms  
 R7—500,000-ohm front panel potentiometer  
 R8—470 ohms  
 R9—1-megohm PC-board potentiometer  
 R10—1000 ohms

### Capacitors

C1—100 pF, ceramic disc  
 C2—27 pF, ceramic disc  
 C3—6–50-pF PC-board trimmer  
 C4, C8—0.1  $\mu$ F, ceramic disc  
 C5—3300  $\mu$ F, 25-volt electrolytic  
 C6—1  $\mu$ F, 10-volt electrolytic  
 C7—100 pF–1  $\mu$ F PC-board trimmer

### Semiconductors

D1–D4—1N914 diode  
 BR1—1.5-amp bridge rectifier  
 DSP1–DSP4—MAN6710, 2-digit, red, common-anode, 0.506-inch, 7-segment LED displays  
 IC1—7490 BCD counter  
 IC2—Harris 7216C frequency counter (Digi-Key ICM7216CJJI)  
 IC3—CD4017 decade counter  
 IC4—7805 5-volt DC regulator  
 IC5—555 timer  
 LED1—miniature red T-1 light-emitting diode  
 LED2—standard green, jumbo, diffused, T-1-3/4 light-emitting diode

### Switches

S1, S5—SPST momentary push button  
 S2–S4—SPST ON/OFF push button  
 S6—SP4T rotary switch  
 S7—SP9T rotary switch  
 S8—DPDT toggle switch  
 S9—SPST ON/OFF push button

### Other components

J1, J2—RCA jack  
 T1—120-to-12.6-volt, 1.2-amp, AC power transformer  
 F1—1.5-amp fuse with holder  
 PL1—120-volt AC power cord  
 XTAL1—10-MHz crystal

**Miscellaneous:** Plastic cabinet (minimum size 8  $\times$  6.25  $\times$  3-inches, 7805 heat sink, bezel for LED2, 5-pin cabinet-mounted terminal strip, knobs, dry transfer lettering, hardware, solder, wire, etc.

**NOTE:** The MAN6710's are available from Quality Technologies Corp., 3400 Hillview Ave., Palo Alto, CA 94304, (415) 493-0400 or (800) 533-6786. The 7216C is available from Digi-Key Corp., 701 S. Brooks Ave., P.O. Box 677, Thief River Falls, MN 56701-0677, (218) 681-6674 or (800) 344-4539. The cabinet is available for \$14.95, from Chaney Electronics, 932 North 94th Way, Scottsdale, AZ 85258, or P.O. Box 4116, Scottsdale, AZ 85261, (602) 451-9407 or (800) 227-7312.

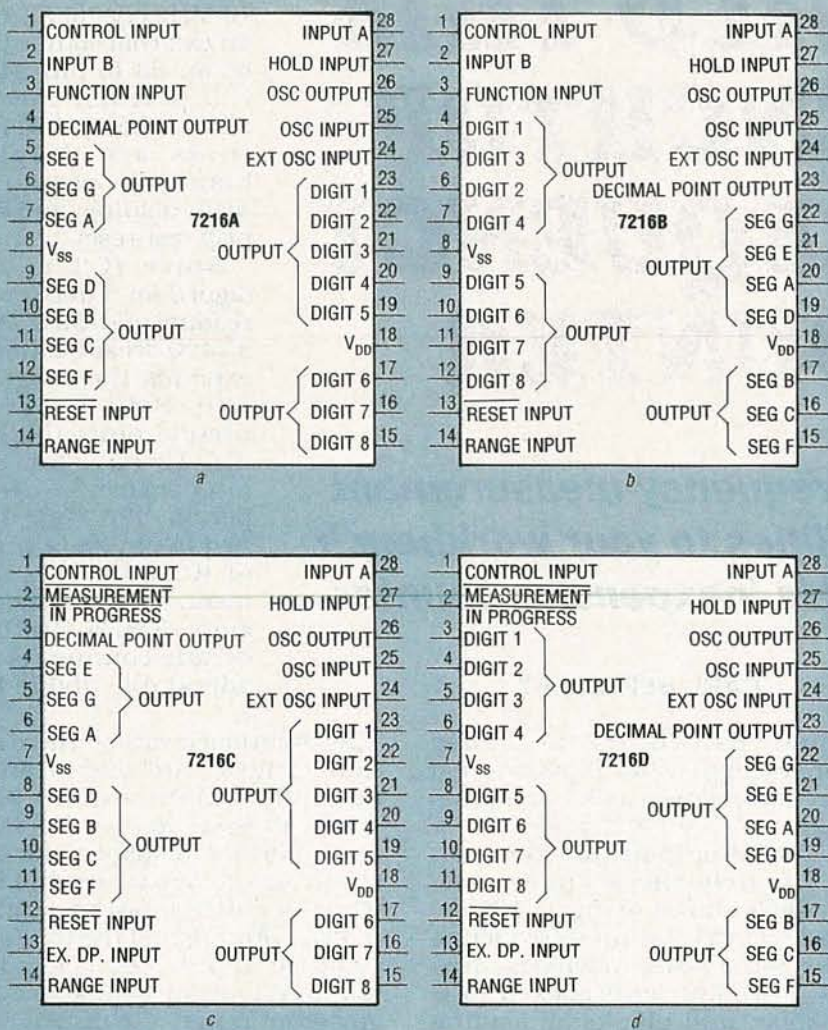

FIG. 1—THE PINOUTS OF ALL FOUR VERSIONS of the 7216. The 7216A/B both take two inputs, for measurements like the ratio of two frequencies, while the 7216C/D have single inputs.

If the frequency counter had adequate bandwidth, it could actually read from 1 kHz–99,999,999 kHz without IC3, or 1 kHz–99.999999 GHz. Of course the frequency response isn't nearly that good, and the counter actually works up to only about 1.8 GHz (using IC3), regardless of S6 or S7.

With S6 set to 0.1 second with IC3 out, the counter displays 0.1 kHz–9,999,999.9 kHz, or 100 Hz–9.9999999 GHz. Setting S6 to 1 second, it displays 0.01 kHz–999,999.99 kHz, or 10 Hz–999.99999 MHz. And, setting S6 to 10 seconds, it displays 0.001 kHz–99,999.999 kHz, or 1 Hz–99.999999 MHz.

If S8 is set to IN, IC3 is on, and the display reading has to be multiplied by the divider factor setting of S7 to get the actual fre-

quency. The maximum divider ratio of 18 may seem like an odd value to end with, but IC3 didn't have enough taps to divide by 20. Never use an input exceeding  $V_{DD}$ ; you'll destroy IC2. Reduce the input gain with R7 and increase for a stable reading.

Regarding DSP1–DSP4, the MAN6710 2-digit, 7-segment LED displays, the digit drivers are in order along the bottom, with the view from the front. Pin 14 is the digit driver for the left-hand digit, and pin 13 is for the right-hand digit. The left-hand digit in DSP4 has the segments and decimal point labeled for reference. The segment driver pins go on the left side in pairs; the former in each pair is a left-hand segment, the latter a right-hand segment. Thus, for example, pin 16 is  $A_L$ , and pin 11 is  $A_R$ .



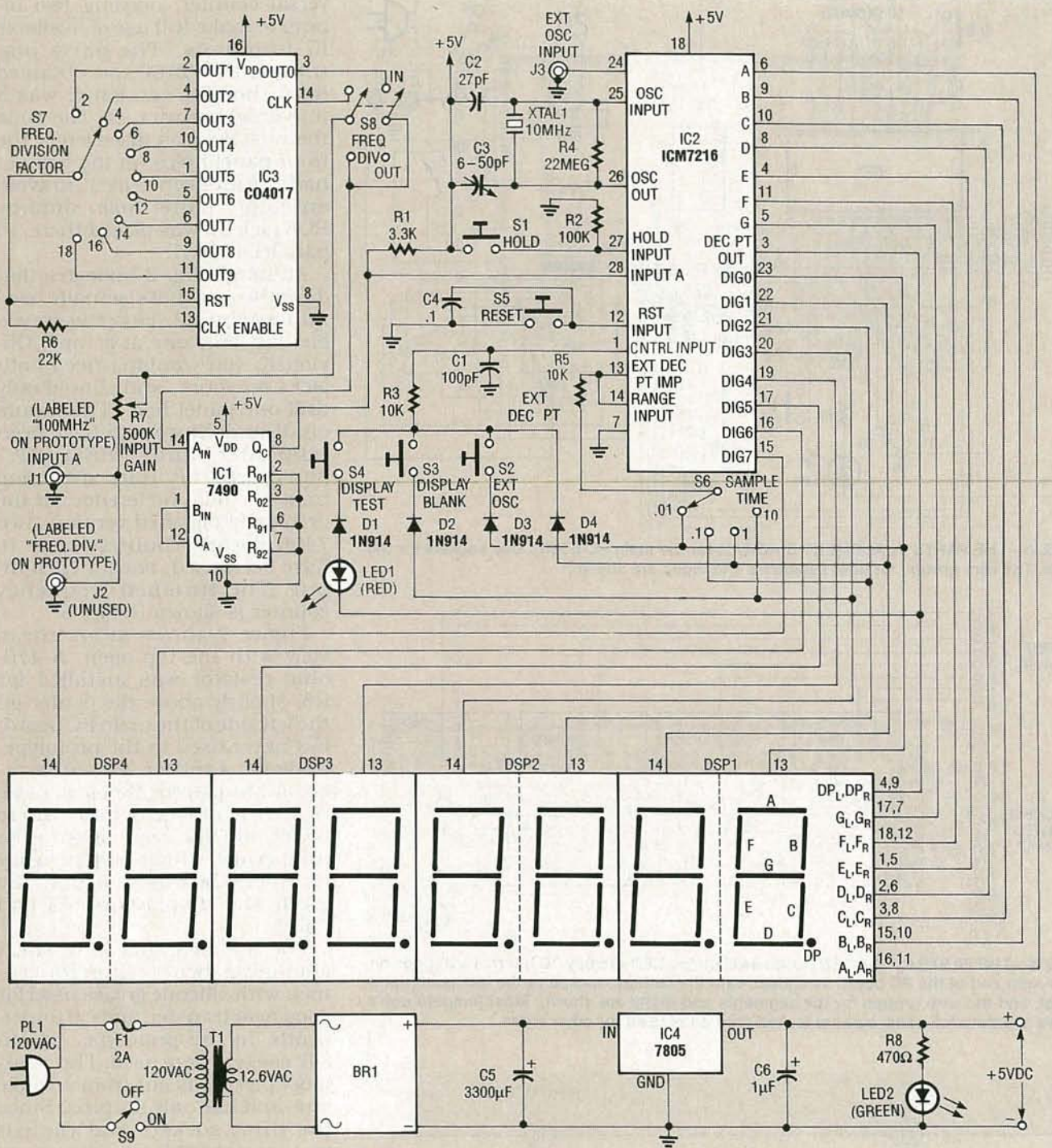

FIG. 2—THE FREQUENCY COUNTER SCHEMATIC; IC2, the 7216C, counts input frequency in decades, stores the result in latches, and drives an 8-digit multiplexed LED display, with leading zero blanking. While the internal oscillator normally uses with 10-MHz crystal XTAL1, J3 takes an external source. Other 7216C features include display blanking, measurement holding, and display test/reset.

### Construction

The parts-placement diagram for the main PC board is shown in Fig. 3, and the display board is shown in Fig. 4; the foil patterns are also provided in this article. The prototype version omitted the power supply now incorpo-

rated in the main PC board. Use 18-pin DIP sockets for the LED-display PC board, and appropriate sockets for the main PC board. The wire groups for both the segments and the digits are indicated in both Figs. 3 and 4, and are omitted for clarity.

The Monsanto MAN6710's are 2-digit, 7-segment, multiplexed, common-anode LED displays; their pinouts are shown in Fig. 5. The B, D, F, and DP segments were connected by PC-board foils, and the A, C, E, and G segments using jumpers; the G jumpers criss-cross the display PC board as they progress. Use multi-colored wire to identify the various segments and digits; digit drivers D1-D8 go to the top of



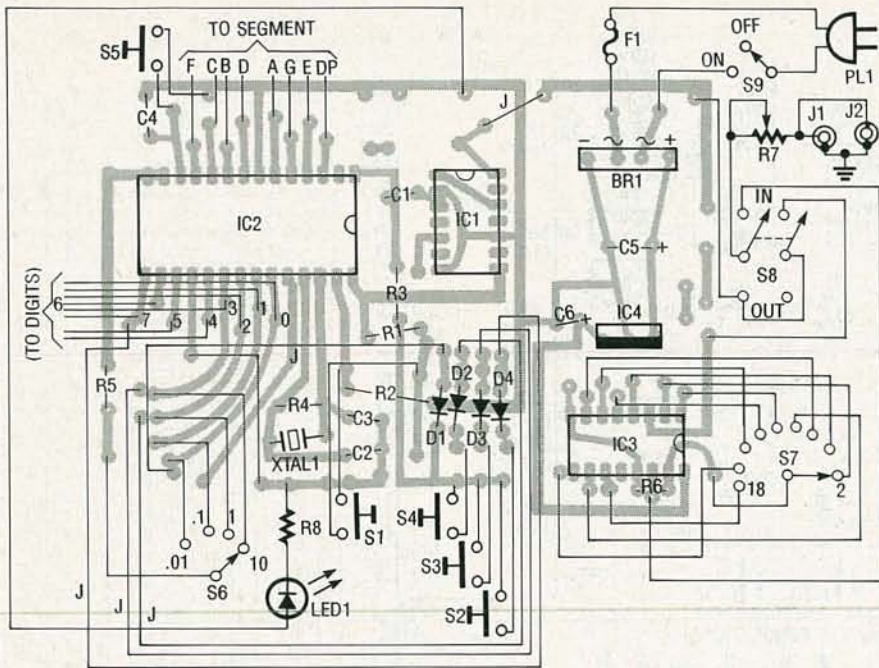

FIG. 3—THE PARTS PLACEMENT DIAGRAM for the main PC board. Use sockets for the IC's. The wire groups for both segments and digits are shown.

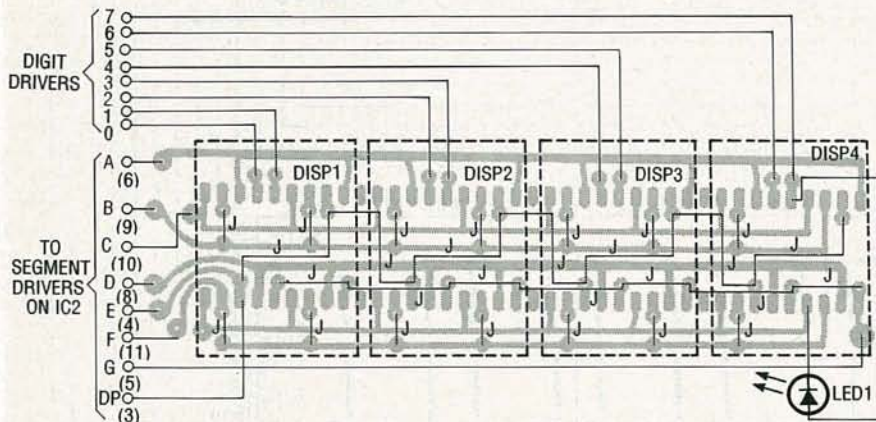

FIG. 4—THE PARTS PLACEMENT DIAGRAM for the LED-display PC board. LED1 goes on the right end of the PC board as shown, with the cathode tacked to the foil itself (not a pad), and the wire groups for the segments and digits are shown. Most jumpers don't have separate foil pads, and are tacked onto pads used for other wires.

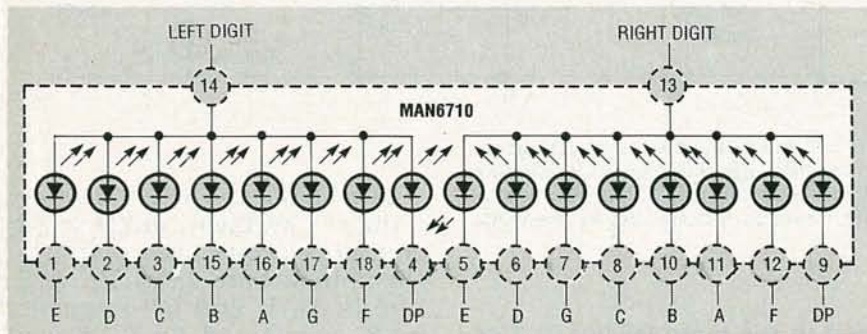

FIG. 5—PINOUTS FOR THE MAN6710 2-DIGIT, 7-segment, common-anode, multiplexed LED display.

the display board. Several jumpers must be tack soldered to the pads on the foil side of the display board.

The reason J1 and J2 are connected together is because in the prototype, the original plan (later abandoned) was to make a uni-

versal counter, needing two inputs to make full use of available IC functions. The parts distributor the 7216C was obtained from thought version C was a universal counter. By the time the mistake was discovered, the front-panel holes on the cabinet had already been drilled. To avoid an empty panel hole, dummy RCA jack J2 was placed there, in parallel with J1.

Although Fig. 2 indicates that J1 is the one that's actually used rather than J2, either was usable, but only one at a time. Obviously, you wouldn't need both jacks on yours, and should only drill one panel hole. The inputs on J1 and J2 were to have been "100 MHz" and "FREQ DIV," purely arbitrary titles stemming from personal preference. In the originally planned version, two 7490 decade counters were to have been used, one for each input. The finished frequency counter is shown in Fig. 6.

Figure 7 shows an overhead view with the top open. A 470-ohm resistor was installed for R8, slightly above the center on the left side of the main PC board, but never used in the prototype. Instead, another 470-ohm resistor was placed off-board, in series with LED2, behind where LED2 and its bezel fit into the front panel. The prototype really used four boards, but only the main and display boards had foils.

The IC4 heatsink is of sheet aluminum, bent to fit in the cabinet, with silicone grease used for good heat transfer, and C6 underneath. In the prototype, 24-pin DIP sockets were used. The right-most piece was cut from a whole one, and has only six pins. Since the three sockets and the cut piece at right fit flush against one another, there's an unused hole between individual displays. To avoid cutting a socket, use 18-pin versions in yours. The 5-pin terminal strip is used as a feed point for the +5 volts from IC4.

Figure 8 shows a closeup view of the LED-display PC board from the foil side. Since three holes were needlessly drilled for J1-J3, there wasn't enough room left for S8, so a notch was cut in the lower left corner of the display PC board, clearly visible in Fig. 8. The wires to LED1 are at upper





FIG. 6—THE FINISHED FREQUENCY COUNTER, shown in display-test mode, with all digits and decimal points lit. J1 and J2 are wired together, but one is unnecessary (see text).

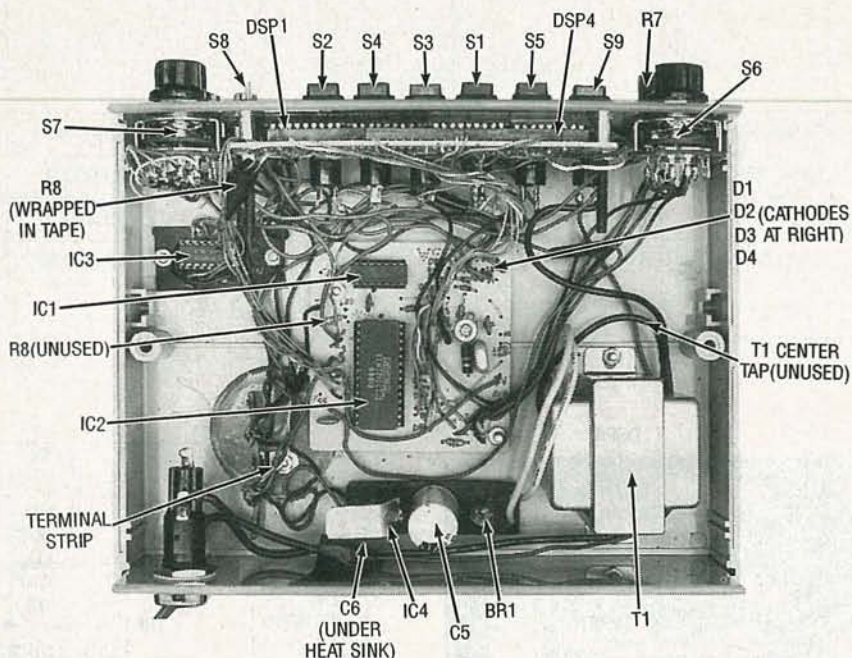

FIG. 7—AN OVERHEAD VIEW OF THE PROTOTYPE; R8 on the main PC board wasn't used. Another off-board 470-ohm resistor is in series with LED2, and IC3 and IC4 were later added to the main PC board. The IC4 heatsink is sheet aluminum with silicone grease; C6 is underneath. The prototype had three complete 24-pin DIP sockets for the LED displays, and part of another, with an unused hole between displays; use 18-pin sockets in yours. The markings shown on D2 and D4 are wrong; the cathodes all point right. The terminal strip is a feed point for the +5 volts from IC4.

right: normal polarity is reversed, with black going to the anode, and white to the cathode. Note the unused pads between individual LED displays, where they fit against one another on the component side.

The prototype cabinet is 8 × 6.25 × 3-inches; drill the front panel holes, and do the labeling before installing the switches, jacks, and display. Use dry transfer lettering with a light coat of clear enamel to prevent damage. The prototype has the labels of the digit drivers used on S6 for setting the display decimal point;

instead, use the sample times shown in Fig. 2. Mount T1, anchor the PC boards, and check for wiring errors.

#### Power-up, test, and calibration

When you apply power, LED2 should glow. Press S4 (DISPLAY TEST), and the display should show all 8's and decimal points, and LED1 should light. If not, disconnect the power and recheck the wiring. With S8 in the OUT position, IC1 is off; set R7 for maximum gain, and apply a signal of known frequency no more than 5 volts in magnitude to J1 or

## Become an EKI Certified Electronics Technician



with EKI's home-study program.

**FREE**  
FULL COLOR  
**CATALOG**

Features:

- Low cost (only \$39 per module)
- 32 modules
- Used in schools all over the world
- Fast delivery
- No contract to sign
- Go at your own pace
- Can be completed in less than 6 months

CALL OR WRITE TODAY:



1-800-453-1708  
1-714-833-8711

McCARTHY  
**EKI** 16631 NOYES AVE  
IRVINE CA 92714

DECEMBER 1990



TABLE 1—IDEAL FREQUENCY COUNTER DISPLAY RANGES FOR ALL S6/S7 SETTINGS

Frequency Divider Setting (S7)	1	2	4	6	8
Sample Time Setting (S6), s					
0.01	1-99,999,999	2-199,999,998	4-399,999,996	6-599,999,994	8-799,999,992
0.1	0.1-9,999,999.9	0.2-19,999,999.8	0.4-39,999,999.6	0.6-59,999,999.4	0.8-79,999,999.2
1.0	0.01-999,999.99	0.02-1,999,999.98	0.04-3,999,999.96	0.06-5,999,999.94	0.08-7,999,999.92
10.0	0.001-99,999.999	0.002-199,999.998	0.004-399,999.996	0.006-599,999.994	0.008-799,999.992
Frequency Divider Setting (S7)	10	12	14	16	18
Sample Time Setting (S6), s					
0.01	10-999,999,990	12-1,199,999,988	14-399,999,986	16-1,599,999,984	18-1,799,999,982
0.1	1.0-99,999,999.0	1.2-119,999,998.8	1.4-139,999,998.6	1.6-159,999,998.4	1.8-179,999,998.2
1.0	0.10-9,999,999.90	0.12-11,999,999.88	0.14-13,999,999.86	0.16-15,999,999.84	0.18-17,999,999.82
10.0	0.010-999,999.990	0.012-1,199,999.988	0.014-1,399,999.986	0.016-1,599,999.984	0.018-1,799,999.982

Note: The actual frequency response is limited to approximately 1.8 GHz for all S6/S7 settings; all values shown here in kHz.

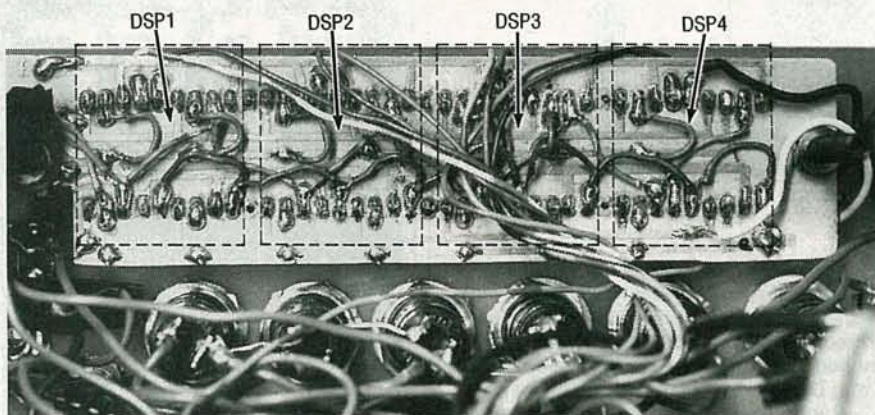

FIG. 8—A CLOSEUP OF THE FOIL SIDE OF THE LED-display PC board. Most jumpers go directly to the foil-side pads; there are no separate holes. Since holes were drilled for J1-J3, there wasn't room for S8, so a notch was cut in the lower left corner. The wires to LED1 (beneath the PC board) are at upper right, black to anode, white to cathode. The pads between the displays are unused, where they fit against one another on the component side.

J2 from a digital pulse generator.

Tune C3 until the display shows the same frequency as your standard, and the counter is calibrated. Switch S6 controls the number of digits of resolution following the decimal point. The frequency is in kHz, so 1 kHz on the 10-second setting of S6 should show up as 1.000. As you increase the sample time on S6, the accuracy increases but so

does the measurement interval. On the 0.1-second setting, the reading is to one decimal place but takes only 0.1 second, whereas on 10.0-second setting, there should be three decimal places, but the sample time also increases accordingly.

The setting on S7 is the factor an input frequency is divided by. Thus, a 100-MHz signal reads 50 MHz on setting S7 to 2, 25 MHz

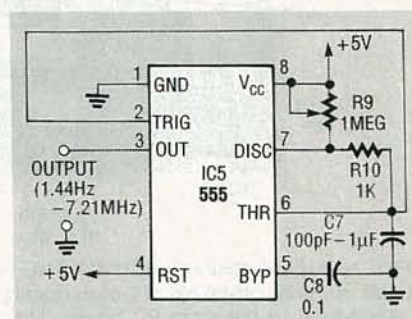

FIG. 9—AN OPTIONAL 555-TIMER ASTABLE square-wave generator for debugging the frequency counter. Both R9 and C7 are variable, to vary the output frequency from 1.44 Hz-7.21 MHz. The breadboard with this circuit on it appears in the lead photo.

on setting S7 to 4, etc. Conversely, 100 MHz on the display on setting S7 to 10 implies a 1-GHz input. S5 resets the display to zero, S1 retains a readout as long as needed, S3 just blanks the display, S2 introduces clocking from an external source on J3, and LED1 indicates overflow.

A simple astable multivibrator square-wave generator is shown in Fig. 9 for calibrating the frequency counter. Adjusting R9 and C7 will vary the output frequency from 1.44 Hz-7.21 MHz. R-E



# OFF THE BENCH AND RUNNING

When **OPTOELECTRONICS** took frequency counters off the bench we created a whole new dimension - Frequency Finding.

Our Handi-Counters™ make Frequency Finding a reality by allowing you to pick-up radio transmitters at the maximum possible distance.

Monitoring Enthusiast, Security Specialists, Broadcast and Design Engineers, Two Way and Amateur Radio Operators and Service Technicians have all made the move. **Shouldn't you?**

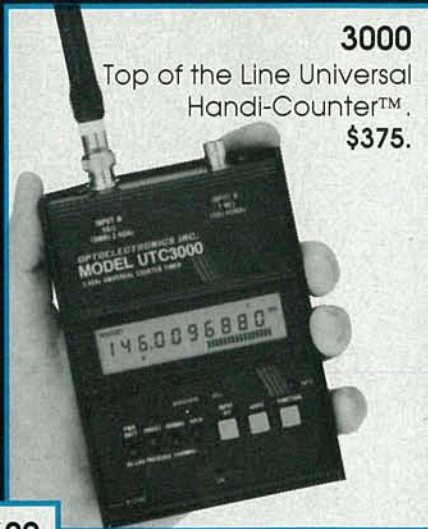

**3000**  
Top of the Line Universal Handi-Counter™. \$375.



**2600**  
Super Sensitive RF Frequency Finder. \$325.



**2210A**  
Full Range Pocket Size LED. \$239.



**8030**  
Bench Portable (Fits in an attache case) with ALL the Handi-Counter™ Features plus More. \$579.

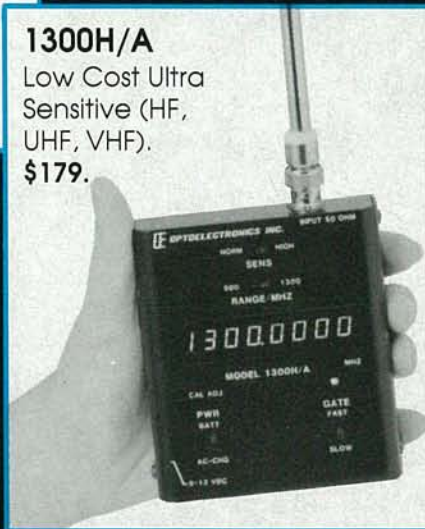

**1300H/A**  
Low Cost Ultra Sensitive (HF, UHF, VHF). \$179.

Model	Range Low High	Display 8 Digit LED	Display 10 Digit LCD	Signal Strength Bargraph	Universal Counter	TCXO Option
8030	10Hz 2.4GHz		•	•	•	± 1ppm add \$125.
3000	10Hz 2.4GHz		•	•	•	± 2ppm add \$ 80.
2600	1MHz 2.4GHz		•	•	•	± 2ppm add \$ 80.
2210A	10Hz 2.4GHz	•				± 5ppm add \$ 75.
1300H/A	1MHz 1.3GHz	•				± 5ppm add \$ 75.

Sensitivity: <1 to <10mV typical. NiCads & AC Charger/Adapter included. Carry Case, Antennas and Probes extra. One year parts & labor warranty on all products.

## OPTOELECTRONICS

Toll Free Order Line:  
**1-800-327-5912**

In Florida call (305)771-2050  
FAX (305)771-2052

5821 NE 14th Avenue • Ft. Lauderdale, FL 33334  
Visa, MC, COD, Cash, M.O. accepted. Personal Check allow 3 weeks. 5% Shipping, Handling, (Maximum \$10) U.S. & Canada. 15% outside continental U.S.A.





# THE CHRISTMAS CARD

*This electronic Christmas tree is sure to make anyone's Christmas a little brighter.*

RON HOLZWARTH

HERE'S A PROJECT THAT YOU'LL BE happy to display in your front window this Christmas season—it also makes a great gift that anyone else would love to display in his or her window. The electronic Christmas tree is actually made from a printed circuit board with traces that form the branches of the tree. Different colored LED's mounted on the board simulate Christmas-tree lights. A built-in microphone picks up any audio signals—such as Christmas music—and different strings of LED's light according to the spectral distribution of the audio within a frequency band selected by the constructor. When installed in the custom metal frame, all of the electronics and the batteries are hidden behind the black mat and protected by the front glass. The end result is an attractive little Christmas tree whose lights will blink in unison with any kind of audio.

The photographs cannot convey the effect of the flashing lights, nor the vivid impression of seeing sound. Music becomes a quickly moving pattern of dancing lights. In fact, any sound becomes an interesting display as the microphone, which tops the tree, picks up any sound in the room. For the hearing-impaired,



it opens up a new window to sound.

The project is also good for those who wish to learn about audio. For example, the tuning fork option only receives frequencies very near A440. But, it is hard to vocalize anything at any pitch without generating a display. In fact, singing notes far lower than A440 generates various displays. In addition, inflections, such as the rise in pitch that usually accompanies the conclusion of a question, are quite visible.

The unit is powered from four AA batteries, although an AC adapter jack is also included so that battery power can be conserved. It is a good idea to use an AC adapter whenever possible, as battery life is limited to about eight hours, depending on the volume level of the audio signal (more or less LED's will light), and the options selected.

The strings of LED's can be more accurately thought of as bar graphs. The device includes an amplitude-discrimination circuit that selects the harmonics of greatest amplitude and displays those harmonics in bar mode, at which time all others are in dot mode.

An interesting experiment would be to interface the board with other circuitry. The outputs of the drivers are TTL- and CMOS-compatible. Since most LED posts can be wire-wrapped, wiring selected outputs to an input port is easy. The device can then function as a front end to allow your computer to monitor sound waves without the complexity of digital filtering. The outputs can also be used to operate relays, allowing lights of any power level to be used.

### Circuit operation

Although the circuit may at first seem complicated, it really isn't. Figure 1 shows a block diagram of the circuit. Signals from the microphone are amplified, filtered, and automatically adjusted for gain in the automatic gain control (AGC) section. The sections that follow are duplicated four times. All four sections are identical except for the frequencies that they handle. Each section has a level-adjust potenti-

ometer, a bandpass filter, level shifter, demodulator and discriminator, and a display driver. Each display driver drives a separate LED bar graph at the output. Three of the bar graphs (A-C) contain ten individual LED's, and one of them (D) contains twenty.

Let's take a look at the schematic in Fig. 2. Power for the unit is supplied by the 4 AA batteries mounted on the board or supplied through the power jack (J1) on the back of the board. Since a bridge rectifier (consisting of diodes D1-D4) is used, DC of either polarity can be used, as well as AC. The batteries are disconnected whenever a plug is in the power jack.

Two large electrolytic capacitors, C19 and C20, damp any transients caused by power surges when a large number of LED's are lit. A voltage divider is formed by IC14, an LM336-2.5, which operates much like a Zener diode, but without nearly as much variation in reference voltage. The device has three terminals, and physically looks like a transistor. However, the third terminal is not needed in this application, so the device is drawn in the schematic as a Zener diode. The reference voltage from IC14 is divided and then wired to op-amp IC1-c which is in a buffer configuration. The output of IC1-c (pin 8) then serves as an analog ground for later portions of the circuit.

The output from the electret microphone (MIC1) appears as an AC waveform. It is amplified by IC1-b, which is configured as a non-inverting amplifier with an adjustable gain set by potentiometer R8.

The next stage is a bandpass filter (IC1-a), which selects the frequencies to be used by later portions of the circuit. Following the initial filter is the AGC that limits the signal when the output reaches approximately 1.1 volts peak-to-peak. The gain will increase slowly during periods of silence, reaching maximum sensitivity after approximately three

seconds.

The AGC section consists of op-amp IC1-d configured as a non-inverting amplifier. When the output of IC1-d increases, Q2 turns on and allows a small amount of current to flow into C4. That will raise the gate voltage of Q1, effectively lowering the resistance of R12, thus decreasing the gain of the amplifier as a whole. In the rest of the discussion, only one filter (filter A which controls bargraph A) will be described, as the others are identical except for a few resistor values.

A level-adjust potentiometer (R17) is next, followed by a buffer (IC2-a). As the potentiometer setting is increased, the amplitude of the filter output increases, causing more LED's to light at the output.

The stage that follows is nothing more than a summing amplifier. The input signal is summed with a portion of the output from the filter that follows. With a little positive feedback from the filter output, the Q is increased. Within the feedback network is another filter which has a resistive divider attached to it that causes it to act as a unity-gain filter.

The next section is the level shift, which is necessary since the output of the filter appears as an oscillation about the analog ground. The display drivers require an input measured from true ground, hence the level shift section is needed to amplify the

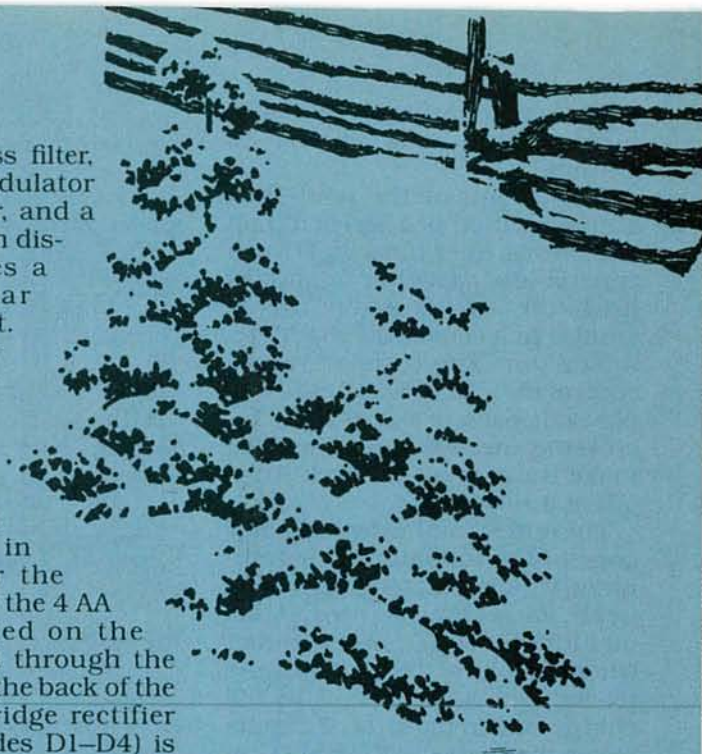



output as well as lower the waveform so that it is relative to ground.

The output of the level-shift section, which is a series of half sine waves, goes through D7 to a resistor and capacitor in parallel (R61 and C14). Note that this is similar to a conventional AM demodulator. The resistor values control the rate at which the display falls back to a zero state. Increasing the resistor values will make the display fall back (turn off) at a slower rate.

The output of the demodulator goes to the amplitude discriminator, which is an op-amp configured as a comparator. Germanium diode D11 will conduct whenever one of the filter outputs reaches 0.2 volts. Thus, C18 will charge and remain at 0.2 volts below the highest DC level. That causes the comparator for the filter output of the highest DC level to switch its output to a high state. That output connects to the control input of one section of a 4066 bilateral switch which connects power to pin 9 of the corresponding LED driver putting it in bar mode.

Resistor R65 is of a much larger value than R61–R64. Thus, when the filter output begins to decrease, the driver returns to dot mode and does not go back to bar mode until the output increases. The time constant is set so that the voltage has significantly decreased in about one second, so the rhythm of the music is displayed as the LED's shift to bar mode at each beat. Varying the RC time constant will make the device operate differently.

Bargraph D is driven by two drivers (IC12 and IC13) stacked end-to-end. They are made to function exactly as the others as far as the dot-to-bar mode transition is concerned. The display drivers (IC9–IC13) control the lighting of the LED's according to the input voltage. A databook should be consulted if you wish to know more about the operation of the display drivers.

### Filters and Q

The Q of a filter defines how narrow the passband is. It is equal to the center frequency divided by the difference in frequency between the -3-dB points. The -3-dB frequency is

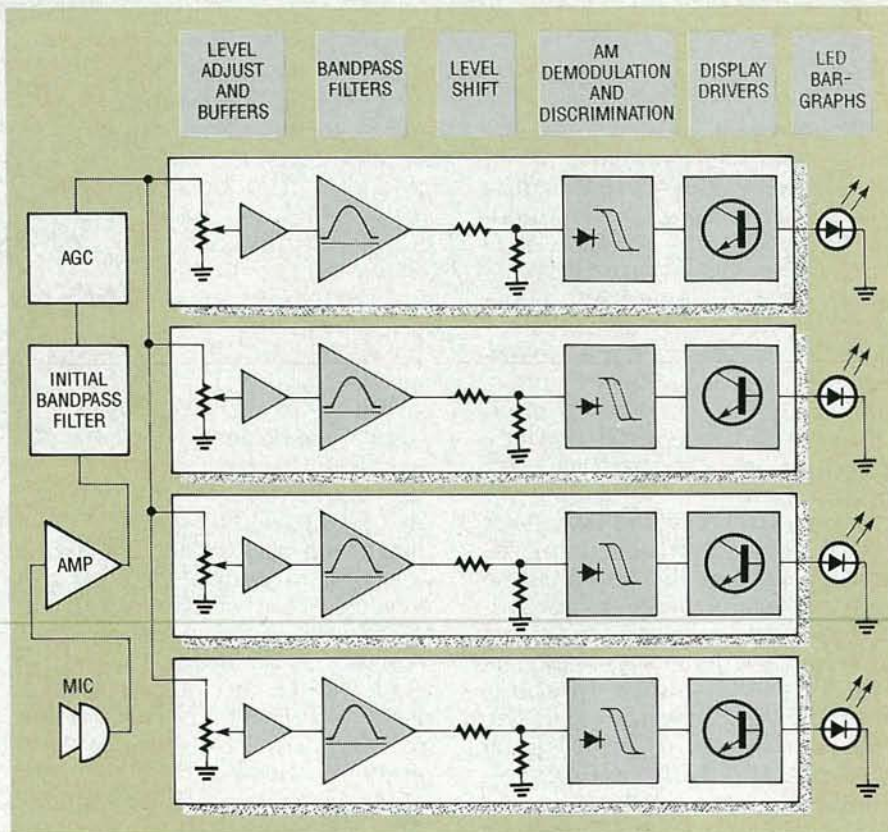

FIG. 1—BLOCK DIAGRAM OF THE CIRCUIT. Signals from the microphone are amplified, filtered, and automatically adjusted for gain.

the frequency at which the peak-to-peak voltage is attenuated by one half from that at the center frequency, assuming a constant voltage at the input.

Assuming we want a center frequency of 440 Hz, which is the American tuning standard for musical instruments, and we want A flat (415.3 Hz), one half step down, to be a -3-dB frequency, and A sharp (466.16 Hz), for the other -3-dB point,  $440 / (466.16 - 415.3) = 8.65$ . That would be the Q required for an attenuation of one half when stepping up or down one key on a piano.

Interestingly enough, the same Q is required to accomplish that across the entire keyboard. This is a necessary consequence of our tuning scale, which is now defined as the twelfth root of two multiplied repeatedly at each step. A logarithmic scale was thus developed by musicians centuries before mathematicians had opened their eyes, so to speak— $17/18$  has been used for the approximation of this factor, which results in an error of less than one percent. It has been used for the construction of

guitars and similar stringed instruments for over three hundred years.

The Delyiannis-Friend bandpass filter (the type used in this project) was first described by T. Delyiannis in 1968. It has a number of advantages over some other filters, such as reduced sensitivity to component tolerances, minimal parts count, and a relatively easy-to-understand design algorithm. It has been described as a bridged-T RC circuit with an op-amp to provide negative feedback.

There are only two parameters needed to design a bandpass filter. They are the center frequency desired for the passband, and the Q, or quality factor. The bandpass filter in its simplest configuration is shown in Fig. 3. That filter has a bandpass center frequency of  $1/2\pi$  Hz. The first step in designing is to assign numerical values—that is, substitute the Q required. Assuming a Q of 4,  $1/2Q = 0.125$ , and  $4Q^2 = 64$ .

After assigning numerical values for each of the components, the filter is scaled up in frequency by dividing the capacitor values



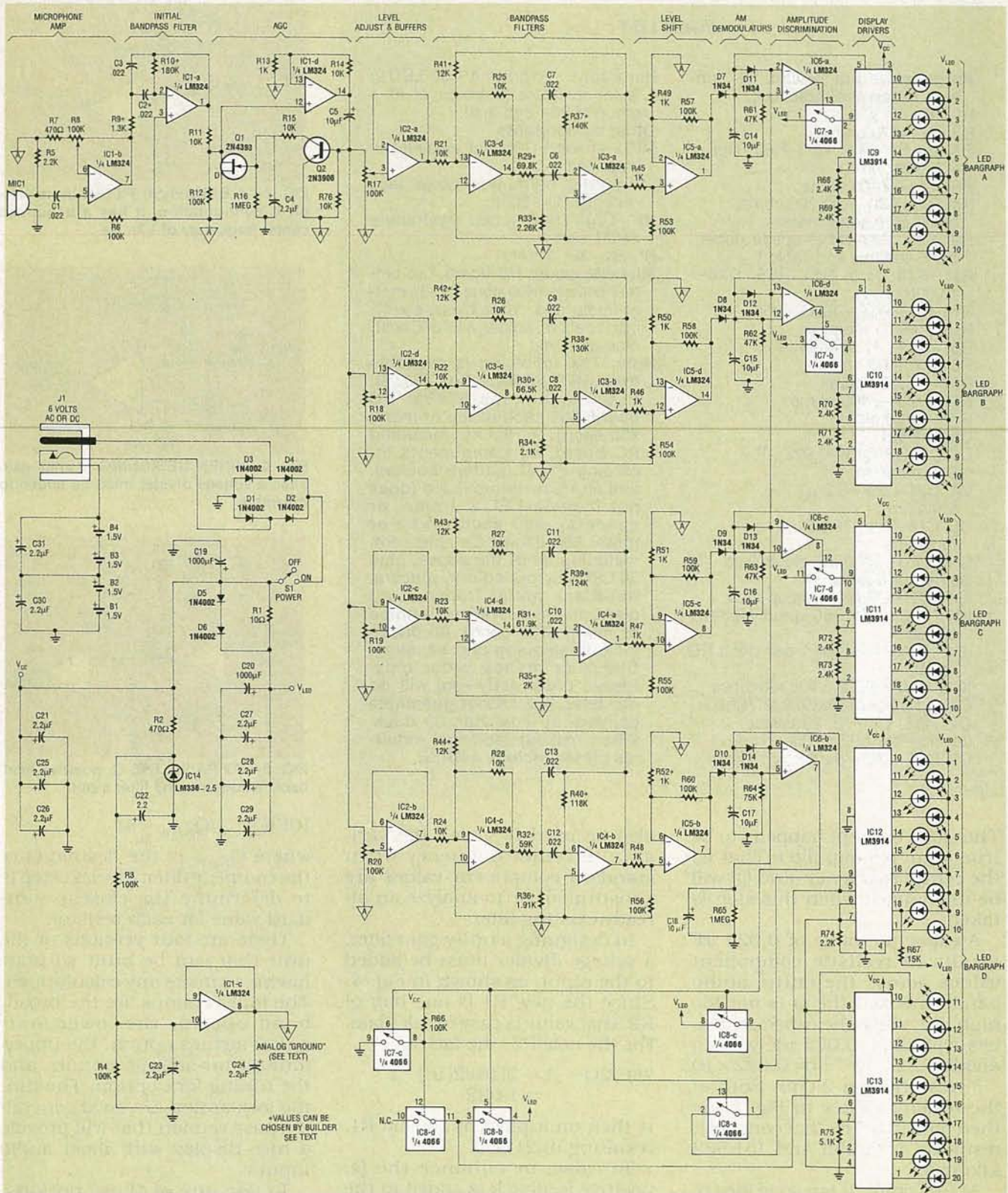

FIG. 2—CHRISTMAS TREE SCHEMATIC. Power for the unit is supplied by the 4 AA batteries or via the power jack on the back of the unit.

by the difference in frequency required. Assume the frequency required is 440 Hz. The difference in frequency required is equal to:

$$f_{\text{NEW}}/f_{\text{OLD}} = 440/(1/2\pi) = 880\pi$$

The capacitor value (0.125 F) is then divided by this number, giving  $4.52 \times 10^{-5}$ , the new capacitor value for our filter.

The next step, scaling to real-

istic values, is best described by an analogy. In an RC network, the time constant remains unchanged if the capacitor value is divided by any constant, just as long as the resistor values are multiplied by the same constant.



## PARTS LIST

All resistors are 1/4-watt, 5%, unless otherwise indicated.

R1—10 ohms  
 R2, R7—470 ohms  
 R3, R4, R6, R12, R53—R60, R66—100,000 ohms  
 R5, R74—2200 ohms  
 R8, R17—R20—100,000 ohms, multiturn potentiometer  
 R9, R10, R29—R44—option dependent, see text and Table 1  
 R11, R14, R15, R21—R28, R76—10,000 ohms  
 R13, R45—R52—1000 ohms  
 R16, R65—1 megohm  
 R61—R63—47,000 ohms  
 R64—75,000 ohms  
 R67—15,000 ohms  
 R68—R73—2400 ohms  
 R75—5100 ohms

### Capacitors

C1—C3, C6—C13—0.022  $\mu$ F, 5% metal film  
 C4, C21—C29—2.2  $\mu$ F, tantalum  
 C5, C14—C18—10  $\mu$ F, tantalum  
 C19, C20—1000  $\mu$ F, electrolytic

### Semiconductors

IC1—IC6—LM324 quad op-amp  
 IC7, IC8—CD4066 quad bilateral switch  
 IC9—IC13—LM3914 bar/dot LED driver  
 IC14—LM336Z 2.5-volt reference  
 Q1—2N4393 or 2N3972 MOSFET  
 Q2—2N3906 PNP transistor  
 D1—D6—1N4002 rectifier diode  
 D7—D14—1N34 germanium diode

Bargraph1—Bargraph4—50 LED's, assorted colors (3 groups of 10, 1 group of 20—see text)

### Other components

MIC1—1-volt PC-mount electret microphone  
 J1—coaxial barrel-type power jack (Shogyo SJ-0202)  
 S1—C&K 7000-series right-angle SPDT switch  
 B1—B4—AA battery

**Miscellaneous:** PC board, two battery holders (Keystone 2223), metal frame and cover glass, six 5/8-inch spacers, solder, a bit of Christmas spirit, etc.

**Note:** The following is available from ART WORKS, Box 753, St. Francis, Kansas 67756: PC board, \$35 each (three or more, \$30 each); Partial kit, including PC board, all components including S1, J1, battery holders, and all 1% resistors listed (does not include LED's, frame, or spacers), \$90 each (three or more, \$80 each); Complete kit, including all of the above, plus 50 LED's in four colors, spacers, flat-black metal frame, front glass and mat, \$125 each (three or more, \$100 each). All prices include shipping and handling. Check or money order only. Please order early—we will do our best, but cannot guarantee delivery in less than 30 days. When making technical inquiries please include a SASE.

The same concept happens to be true in an op-amp filter. That is, the center frequency (and  $Q$ ) will be unchanged when this step is taken.

A capacitor value of 0.022  $\mu$ F results in realistic component values across the entire audio band, provided the  $Q$  is not too high. So, since the capacitor values will all be 0.022  $\mu$ F, we can divide  $4.52 \times 10^{-5}$  by  $0.022 \times 10^{-6}$ , resulting in 2,055. Both of the resistor values in Fig. 3 are then multiplied by that constant, resulting in 2,055 and 131,533 kilohms.

At this point, it is a good idea to check your work. The values just obtained should be substituted into the following equation:

$$f = \frac{1}{2\pi C \sqrt{R_1 R_2}} \\ = \frac{1}{2\pi (0.022 \times 10^{-6} \times \sqrt{2,055K \times 131,533K})}$$

The result should be the original frequency. That equation can

also be used to check the variance in center frequency when standard component values are substituted, or to analyze an already existing filter.

In designing a unity-gain filter, a voltage divider must be added to the input, as shown in Fig. 4. Since the new R1 is one half of R2, that value is easy to calculate. For the new R3, the factor

$$2Q^2/2Q^2 - 1 = \frac{2(16)/2(16) - 1}{1} \\ = 1.032$$

is then multiplied by the old R1, resulting in 2121.5.

To raise, or enhance the  $Q$ , positive feedback is added to the filter input, as in Fig. 5. The values for R1, R2, and R3 of Fig. 5 do not need to have the same scale factor as used before. A fine value for R1 and R2 is 10K; R3 will then be

$$10K(Q_{NEW}/Q_{NEW} - Q)$$

or, for our example,

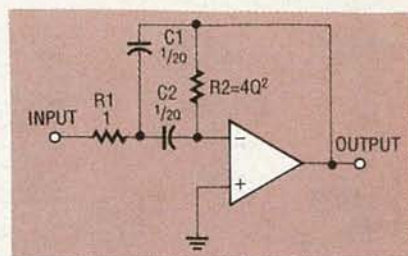

FIG. 3—A BANDPASS FILTER in its simplest configuration. It has a bandpass center frequency of  $1/2\pi$  Hz.

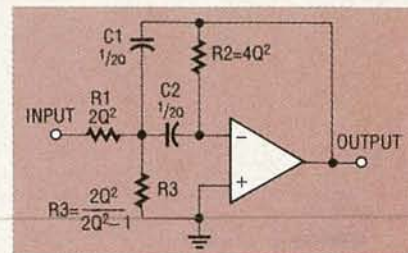

FIG. 4—WHEN DESIGNING a unity-gain filter, a voltage divider must be added to the input.

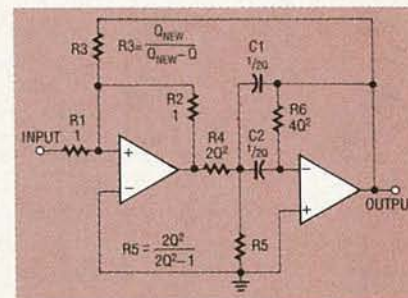

FIG. 5—TO RAISE THE  $Q$ , positive feedback is added to the filter input.

$10K(Q_{NEW}/Q_{NEW} - 4)$

where  $Q_{NEW}$  is the desired  $Q$  of the complete filter. The last step is to determine the closest standard value for each resistor.

There are four versions of the unit that can be built without having to make any calculations. The four versions are the broadband option, the lower-four-guitar-strings option, the upper-four-guitar-strings option, and the tuning fork option. The tuning fork option is a good general-purpose version that will provide a nice display with most audio inputs.

To use any of those options, you must refer to Table 1; it shows the resistor values you'll need to use for the four filters to achieve the specified frequencies. Also, depending on which option you choose, the initial bandpass filter must be set up accordingly.

To use Table 1, first refer to the top section to determine the re-



sistor values for the initial band-pass filter, the other four band-pass frequencies, and any special provisions for the particular option. Then, from the bottom section, determine the resistor values for the other four filters according to the frequencies listed in the top section. The resistor numbers shown (R29, R33, and R37) are for filter A. For filter B, add 1 to the resistor number (for example, R29 becomes R30, etc.). For filter C, add 2 to the resistor number, and for filter D, add 3.

Although you can assign any of the four frequencies to any of the four filters, the display will be most interesting if you use the lowest frequency for filter A, next highest for B, and so on. Note that where it says to delete a component, you should leave it out but DO NOT jumper the pads on the board. Where it says to jumper a component, you should leave it out and solder a jumper between the pads.

### Construction

If you like, you can etch your own PC board since the foil patterns for the double-sided board are provided. However, an etched, drilled, plated-through, and silkscreened board is available from the source mentioned in the parts list. Keep in mind that the cosmetic effect of the green mask, silver branches, and white snow will be lost if you make your own board. Locating the components for installation is also easier using the pre-made silkscreened board. Complete and partial kits for the Christmas tree are also available.

Before beginning construction, you have to decide on how you want your LED's arranged. The author's intention was to make each detected harmonic a separate color. However, you are free to arrange the LED's in any pattern you choose, and you can also use whatever colors you like. In any case, the silk screening on the pre-made board indicates which bar graph each light belongs to; there are short white lines between the LED leads. The lines going up (from left to right) are for bargraph A, the horizontal lines are for bargraph B, and the ones going down (from left to right) are for bargraph C. Bar-

TABLE 1

#### Lower Four Guitar Strings Option: (E3, A3, D4, G4)

Initial Filter Q = 1.5                      Center Frequency = 270 Hz  
R9 = 9.1K                                      R10 = 82K                                      R41-R44 = 11K

#### Upper Four Guitar Strings Option: (D4, G4, B4, E5)

Initial Filter Q = 1.5                      Center Frequency = 470 Hz  
R9 = 5.1K                                      R10 = 47K                                      R41-R44 = 11K

#### Tuning Fork Option: (A4 flat, A4, A4 sharp, B4)

Initial Filter Q = 5.8                      Center Frequency = 470 Hz  
R9 = 1.3K                                      R10 = 180K                                      R41-R44 = 12K

#### Broadband Option: (E2, A3, B4, F6 sharp)

(Jumper C2, delete C3)  
R9 = 1K    R10 = 100K                                      delete R41-R44

Note (frequency)	R29	R33	R37
E3 (164.81 Hz)	174K	5.62K	348K
A3 (220 Hz)	133K	4.22K	261K
D4 (293.66 Hz)	97.6K	3.16K	196K
G4 (392 Hz)	73.2K	2.37K	147K
A4 flat (415.3 Hz)	69.8K	2.26K	140K
A4 (440 Hz)	66.5K	2.10K	130K
A4 sharp (466.16 Hz)	61.9K	2K	124K
B4 (493.88 Hz)	59K	1.91K	118K
E5 (659.26 Hz)	44.2K	1.40K	88.7K
E2 (82 Hz)	11K	delete	680K
A3 (220 Hz)	4.22K	delete	261K
B4 (493.88 Hz)	1.8K	delete	118K
F6 sharp (1480 Hz)	620 ohms	delete	39K

NOTE: All versions except the broadband option require 1% resistors.

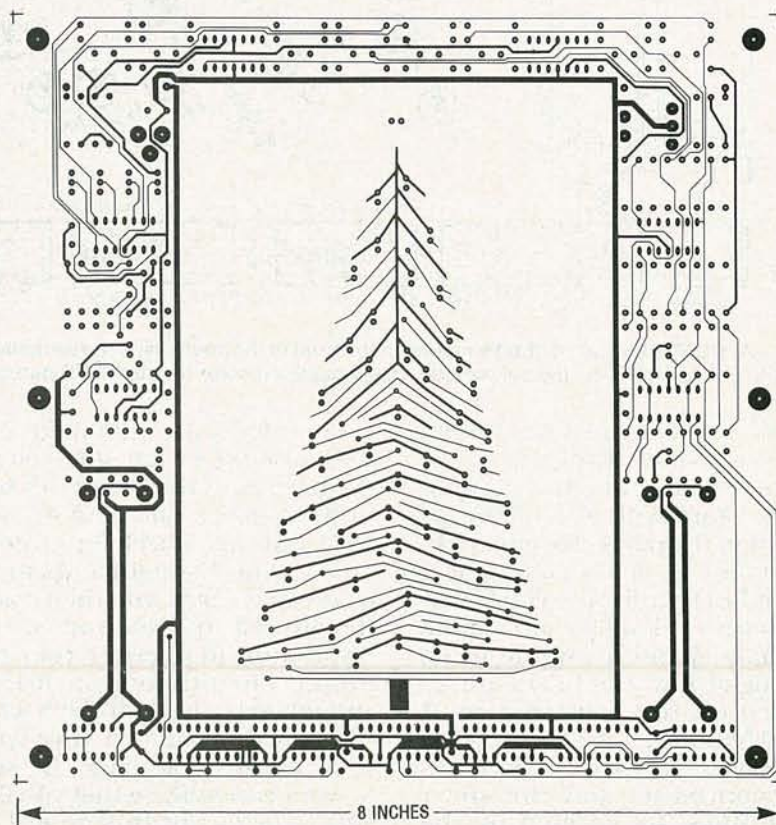

COMPONENT SIDE of the Christmas tree at half the actual size.



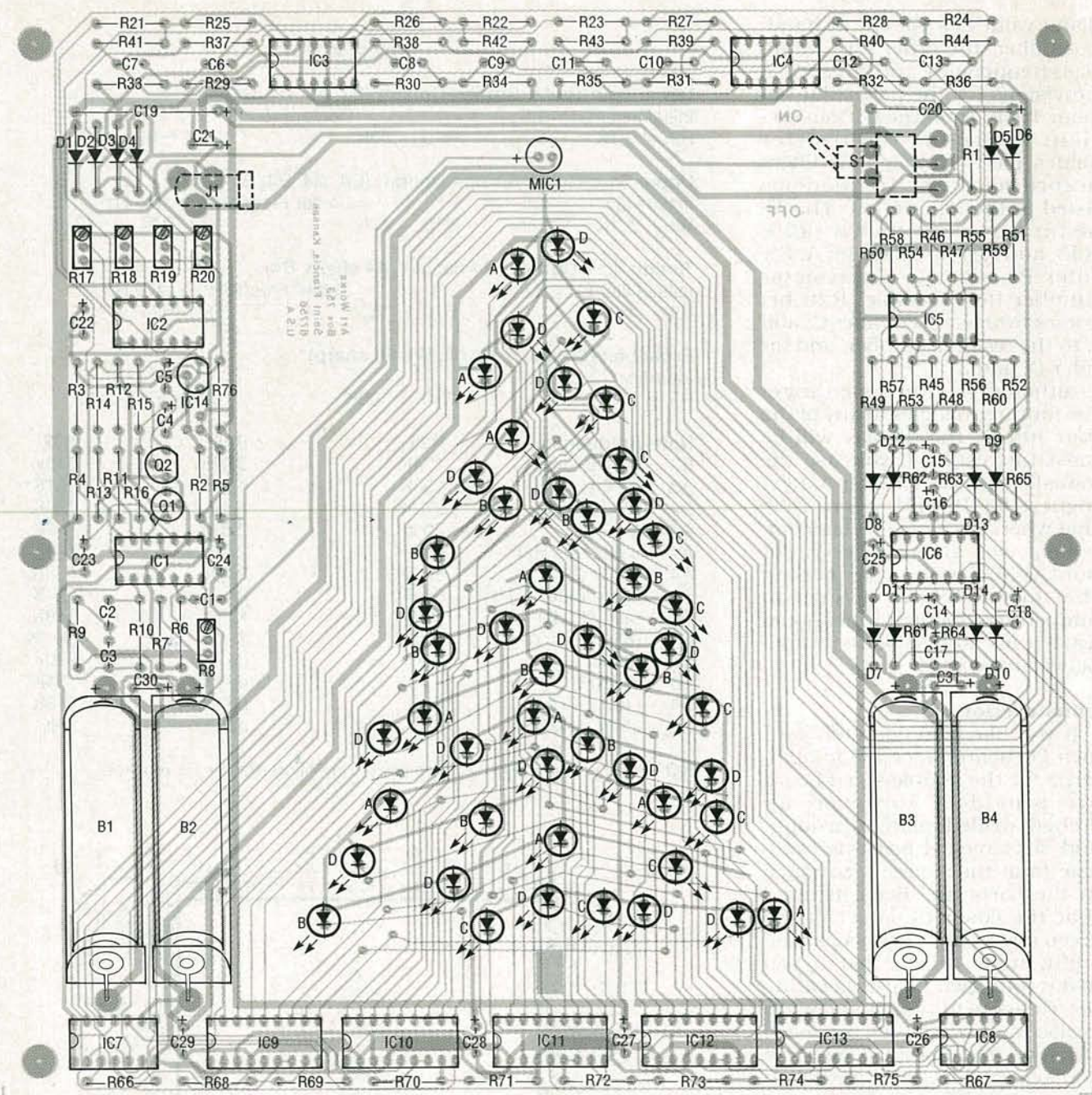

FIG. 6—ALL OF THE COMPONENTS mount on the front of the board, with the exception of J1 and S1; they mount on the solder side. Use a separate color for each LED bargraph.

graph D is indicated by the absence of a short white line.

When installing the components, start with the LED's, as shown in the parts-placement diagram of Fig. 6. The letters next to the LED's indicate which bargraph they belong to. You should probably spend a minute or so looking at how the LED's are arranged on the printed circuit board because, once the device is assembled, the pattern becomes very confusing and the short white lines are covered by the LED's.

The LED's are installed with the cathode (the flat side) toward the bottom of the board. It's best to first solder one lead of each LED and then check for uniform positioning. Straighten them out where necessary, and then solder the other leads. Remember, that if you want to interface your tree to other circuitry later on, to leave enough extra lead on the back of the board to allow a wire-wrap connection to be made. Be sure to work carefully, so that you'll be able to bring out this project for many a Christmas to come. If you

install all the components properly, it's very likely that the device will operate correctly right off the bat.

From the photo in Fig. 7, you can see the six spacers that are installed on the board to hold it in place within the metal frame. It's a good idea to install the spacers now, since they will protect the LED's from being damaged and can also support the board steadily. Now continue installing the rest of the components on the board.

You must now decide what fre-



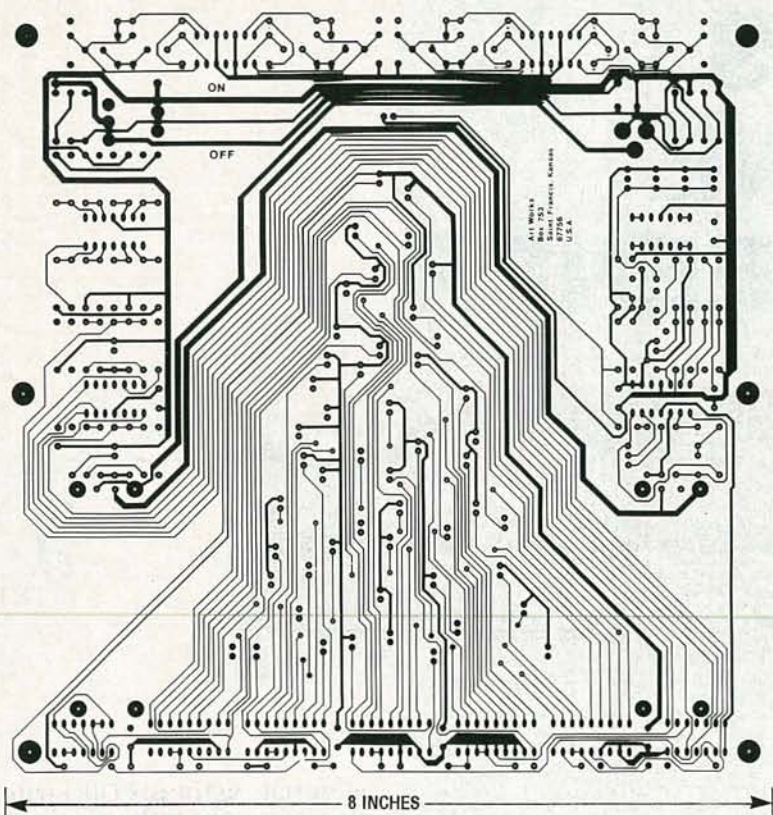

SOLDER SIDE of the Christmas tree at half the actual size.



FIG. 7—THE SPACERS THAT HOLD THE BOARD in place in the metal frame should be installed early to prevent damage to soldered components.

quencies your Christmas tree will respond to. If your device is to be an assistance to the hearing-impaired, the broadband option will be the best, as both low frequencies and the high pitch of a police siren will be detected. For a musical version, you will have to make a decision based on your instrument of choice. Perhaps you can consult with a musician friend on this. You can re-tune the device at any time by simply changing a few resistors. All the components required for each suggested version are included in the kit. Remember that the initial filter must be "in harmony" with the other filters. They cannot detect frequencies that the initial filter doesn't pass. Refer to Table 1 when choosing frequency determining resistor values, or you are free to calculate your own values.

A word to the wise: put a set of batteries in the holders before soldering them. If you don't, the contacts on the battery holders are too close together which makes battery changing extremely difficult. Also, remember that the ON/OFF switch and the DC power jack mount on the solder side of the board as indicated by the dashed lines in Fig. 6.

### Checkout

After checking for incorrectly installed components, poor solder joints, and shorts, and making sure to correct any problems, install a set of batteries or connect a 6-volt power source to the power jack. Turning the power switch on will cause many of the LED's to light. After which point, they will step down to position one, then go out. This is normal operation as the device approaches steady state. Slowly increase the gain of the initial amplifier by turning R8 clockwise. Go back and forth between one of the level-adjust potentiometers and R8, increasing them a little bit each time until one of the bargraphs responds to the sound of your voice. Make sure that none of the potentiometers are set too high, as troublesome oscillations may occur.

Alternatively, connect a voltmeter to the junction of R15 and R16 and increase the setting of R8 until speaking directly into

*continued on page 90*



# BUILD THIS TELEPHONE CALL SCREENER

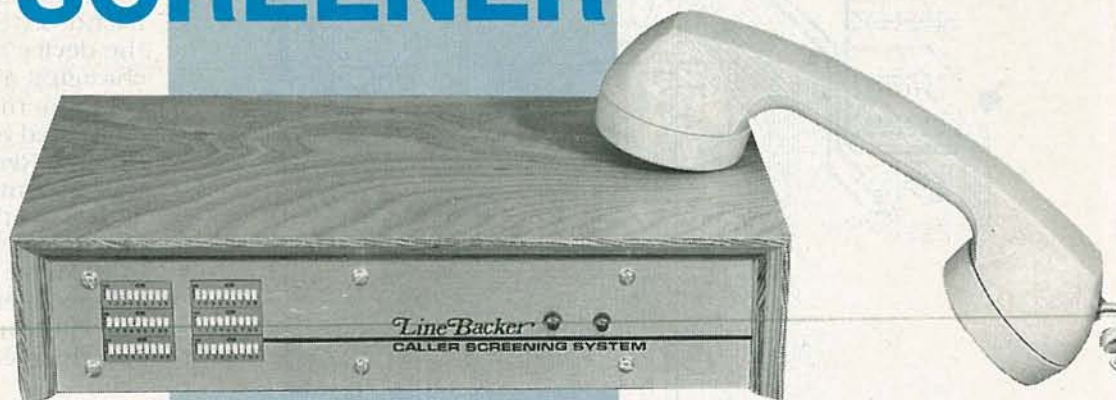

LAST MONTH WE COVERED ALL OF the operating theory concerning the CallScreen unit. This month we will finish up the story by building the unit.

## Construction

Construction of the CallScreen essentially involves stuffing the two PC boards; the main board and the front-panel board. The use of PC boards with plated-through holes will greatly ease and speed up the assembly.

The main PC board includes circuitry for the call routing adapter (CRA). The parts-placement diagram for the main board is shown in Fig. 3. If that feature is not going to be used, the CRA corner of the PC board can be removed with a hack saw. Then the ringer transformer can be placed in the cutout space. That will result in a very compact unit if a wall-type power transformer is used. Also, the CRA can be connected as an outboard unit in its own project box; all you have to do is make the nine connections to the main board. You can combine CRA switches S101 and S102 into a single DPDT center-off toggle switch.

The telephone input/output connections to the main board are made using a standard telephone extension cord cut in half, with the cut ends soldered directly to the main board. That

***Get ready to give out your access codes, but only to the people who you want to hear from!***

JOHN G. KOLLER

makes it easy to place the CallScreen out of sight. The CRA jacks, however, are mounted directly to the PC board. All parts on the main board are mounted on the component side.

The parts-placement diagram for the front-panel PC board is shown in Fig. 4. All parts mount on the component side of the board with the exception of the six DIP switches and the two screen-status indicators (LED1 and LED2); those parts mount on the solder side so they can protrude through the front-panel cutouts (see Fig. 5).

The builder may wish to simplify both the assembly and cutting out the front panel by

eliminating the six DIP switches. You can simply hard wire your selected codes during assembly. Future code changes could be made but would require moving jumper wires. Hard wiring of access codes is done by soldering a 2-inch wire to the common foil of each of the six DIP-switch traces. The wires are then soldered to the selected digit pads. Figure 4 shows the outline of the code-selector switches and the digits (1-9) accessed by each switch position. Remember that as the DIP switches are on the solder side.

When soldering components to PC boards without plated-through holes, always make sure that the leads are soldered on both sides. Missed solder connections are a frequent source of problems during the initial check out. Also, if a PC board without plated-through holes is used, hard wiring of the code connections is recommended. That's because, with the DIP switches in place, top soldering cannot be done. However, one way around that is to use adhesive copper foil attached to the bottom of the switch body and soldered to the common row of connections. The end of the copper foil is then brought out from under the end of the switch and connected to the common foil. A copper pad without holes is provided on the foil for this purpose.



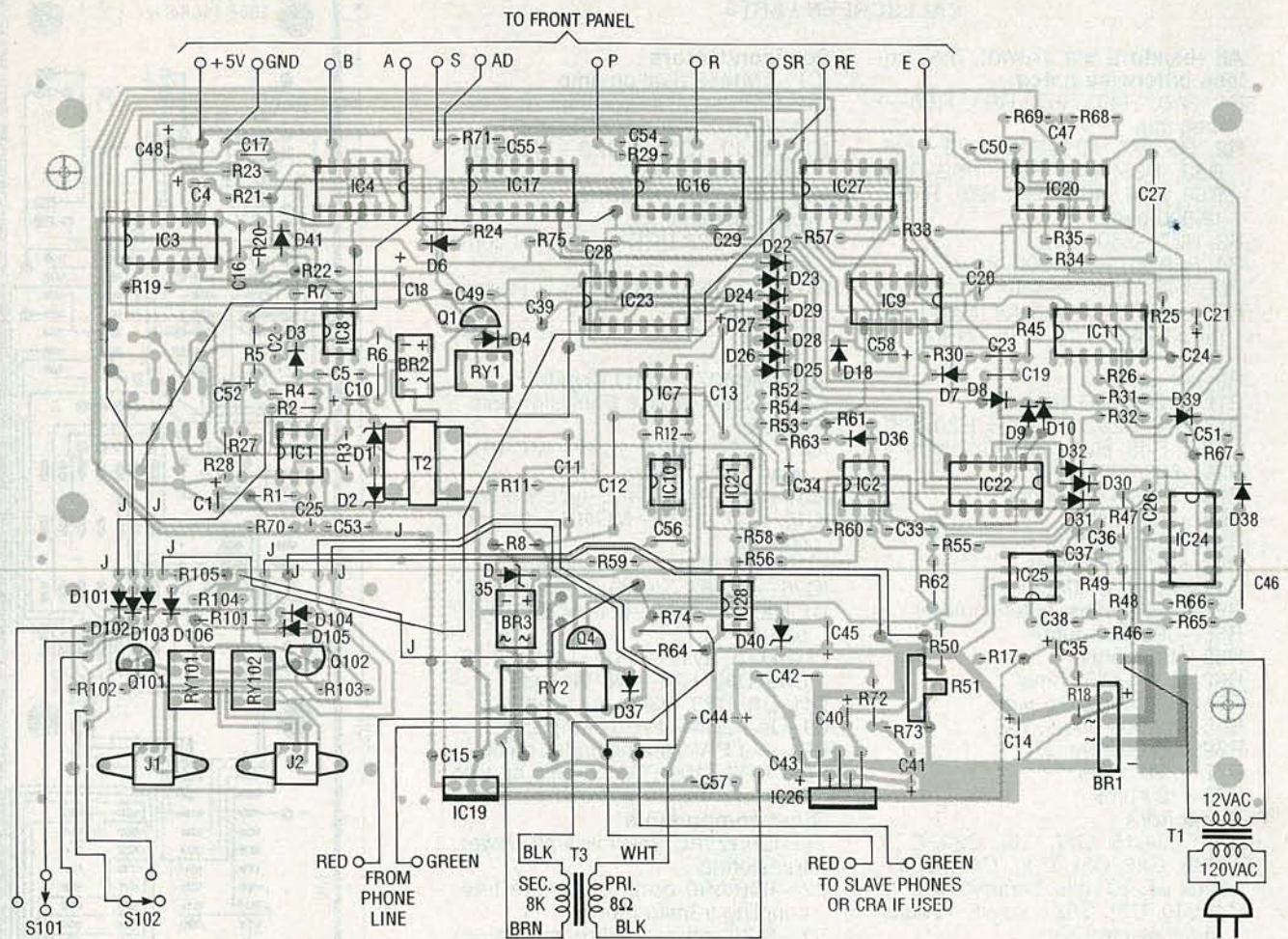

FIG. 3—PARTS-PLACEMENT DIAGRAM for the main board. Note that the CRA parts also mount on this board, although the two circuits are completely separate.

On the assembly drawing for the front-panel PC board (Fig. 4), leads are shown for the local screen-mode select switches. When used, they are simply SPST momentary pushbuttons. Typ-

ically, they are not used since most modern telephones are of the Touch-Tone® type, and screen-mode changes can be made from any such phone connected to the CallScreen output

jack. When the CRA is switched on, remote screen selection from connected telephones is automatically disabled as a security measure in case an answering machine or FAX machine an-

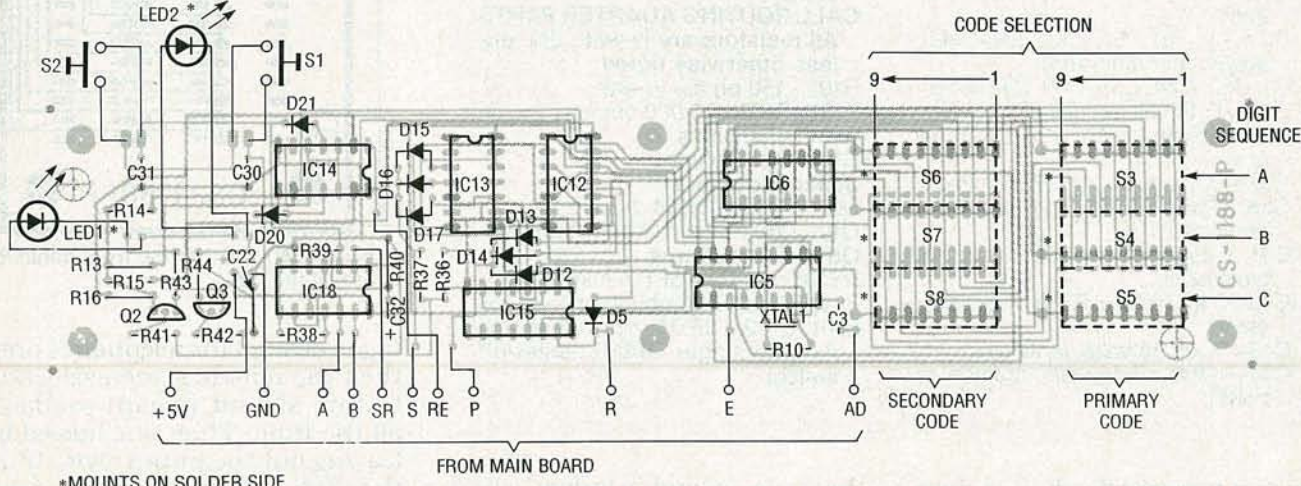

FIG. 4—PARTS-PLACEMENT DIAGRAM for the front-panel PC board. The DIP switches can be left out if you hard wire the access codes.



## CALLSCREEN PARTS

**All resistors are 1/4-watt, 5%, unless otherwise noted.**

R1, R10, R46, R57, R65, R68—1 megohm  
 R2, R5, R7, R17-R19, R23, R26, R32, R33, R36-R42, R52-R55, R58, R60, R63, R67, R70, R75—10,000 ohms  
 R3, R27—560 ohms  
 R4, R29, R71—47,000 ohms  
 R6—560 ohms, 1/2-watt  
 R8—metal-oxide varistor (MOV) surge suppressor, 130 VRMS, 15 joules  
 R9—not used  
 R11, R12—2200 ohms  
 R13-R16, R20, R24, R25, R30, R31, R34, R45, R61—100,000 ohms  
 R21—680,000 ohms  
 R22, R50—4700 ohms  
 R28—680 ohms  
 R35—51,000 ohms  
 R43, R44—180 ohms  
 R47-R49—200,000 ohms  
 R51—2000 ohms, potentiometer  
 R56—390,000 ohms  
 R59—100 ohms  
 R62, R74—470 ohms  
 R64—150 ohms, 1/2-watt  
 R66—82,000 ohms, 1%  
 R69—33,000 ohms  
 R72—220 ohms  
 R73—10 ohms

### Capacitors

C2, C3, C16, C17, C19, C20, C23, C25, C28-C31, C39, C47, C56—0.02  $\mu$ F, 20 volts, ceramic disc  
 C4, C10, C21, C52—22  $\mu$ F, 16 volts, radial electrolytic  
 C5, C15, C22, C24, C26, C33, C49, C50, C51, C54, C55, C57—0.1  $\mu$ F, 20 volts, ceramic disc  
 C6-C9—not used  
 C11—0.33  $\mu$ F, 250 volts, polypropylene  
 C12—0.47  $\mu$ F, 250 volts, polypropylene  
 C13—10  $\mu$ F, 50 volts, axial electrolytic  
 C14—2200  $\mu$ F, 25 volts, radial electrolytic  
 C18—100  $\mu$ F, 10 volts, radial electrolytic  
 C27—4.7  $\mu$ F, 10 volts, axial electrolytic, non-polarized  
 C1, C32, C34, C35, C40, C48, C58—10  $\mu$ F, 10 volts, radial electrolytic  
 C36—0.039  $\mu$ F, 20 volts, ceramic disc  
 C37—0.01  $\mu$ F, 20 volts, ceramic disc  
 C38, C53—0.05  $\mu$ F, 20 volts, ceramic disc  
 C41, C45—470  $\mu$ F, 10 volts, radial electrolytic  
 C42, C46—0.22  $\mu$ F, 50 volts, polyester  
 C43—1  $\mu$ F, 35 volts, tantalum  
 C44—4700  $\mu$ F, 16 volts, radial electrolytic

### Semiconductors

IC1—LM1458 dual op-amp  
 IC2, IC25—LM741 op-amp  
 IC3—MC4001 quad NOR gate  
 IC4, IC12-IC14, IC22—MC4081 quad AND gate  
 IC5—SSI 202 DTMF receiver (Silicon Systems, Inc.)  
 IC6—MC4028 BCD-to-decimal converter  
 IC7—TCM1520 ring detector (Texas Instruments)  
 IC8, IC21—4N33 Darlington optocoupler  
 IC9—MC4071 quad OR gate  
 IC10, IC28—MCT-2 transistor optocoupler  
 IC11, IC20, IC24, IC27—MC4011 quad NAND gate  
 IC18—MC4013 dual D-type flip-flop  
 IC15-IC17, IC23—MC4017 decade counter  
 IC19—MC7805 5-volt regulator  
 IC26—LM383 7-watt power amplifier  
 D1, D2, D35, D40—5.1-volt Zener diode  
 D3-D10, D12-D18, D20-D32, D36-D39, D41—1N914 diode  
 D11, D19, D33, D34—not used  
 Q1-Q4—2N4401 NPN transistor  
 BR1—50-PIV 1.5-amp bridge rectifier  
 BR2, BR3—100-PIV 0.5-amp bridge rectifier

### Other components

T1—120/12VAC 950 milliamp power transformer  
 T2—600/600-ohm telephone line coupling transformer  
 T3—8/8K ohm 10-watt matching transformer (use 8-ohm and 0.625-watt taps on a 70-volt line transformer)  
 XTAL1—3.58-MHz colorburst crystal  
 S1, S2—SPST momentary pushbutton switch  
 S3-S8—9-position DIP switch  
 RY1—SPST N.O. miniature relay, 5-volt, 70-ohm coil (or nearly any other 5-volt miniature relay)  
 RY2—DPDT miniature relay, 12-volt, 290-ohm coil (between 260-400 ohms)

### CALL ROUTING ADAPTER PARTS

**All resistors are 1/4-watt, 5%, unless otherwise noted.**

R101—150 ohms, 1/2-watt  
 R102, R103—10,000 ohms  
 R104—330 ohms  
 R105—1000 ohms

### Semiconductors

D101-D106—1N914 diode  
 Q101, Q102—2N4401 NPN transistor

### Other components

RY101, RY102—SPDT miniature relay, 12-volt, 320-ohm (nominal) coil  
 S101, S102—SPDT miniature switch (or use single DPDT center-off switch)

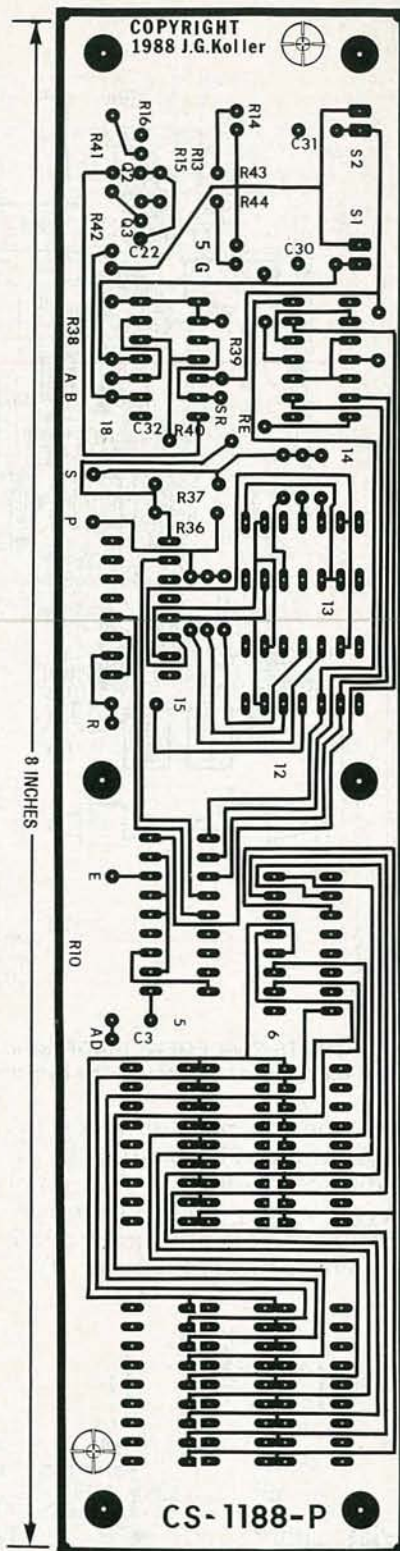

COMPONENT SIDE of the front-panel PC board, at full size.

ing is desired for telephones only, then the remote screen selection feature should remain available all the time. That is achieved by leaving out the jumper wire from the CRA terminal E to the main-board TPV.

When the two boards are

swers a processed call. It is done so that the screen modes cannot be changed by the caller during

the seven-second "window" when an off-hook is raised at the Call-Screen/CRA output. If call rout-



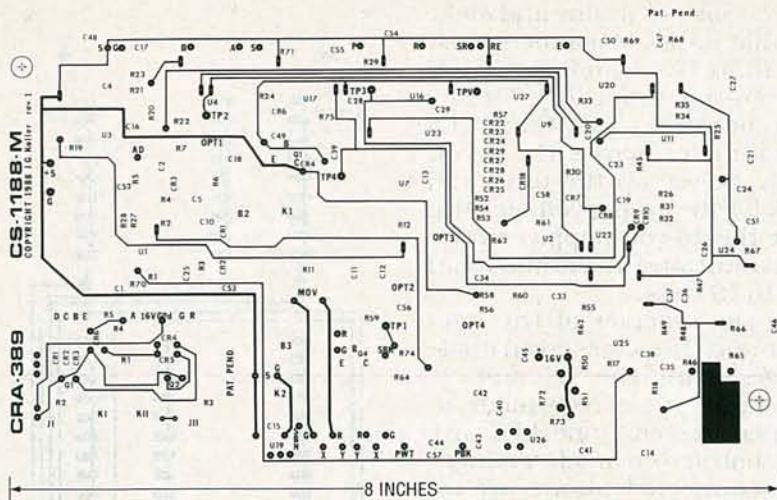

COMPONENT SIDE of the main circuit board, shown here at half of its actual size.

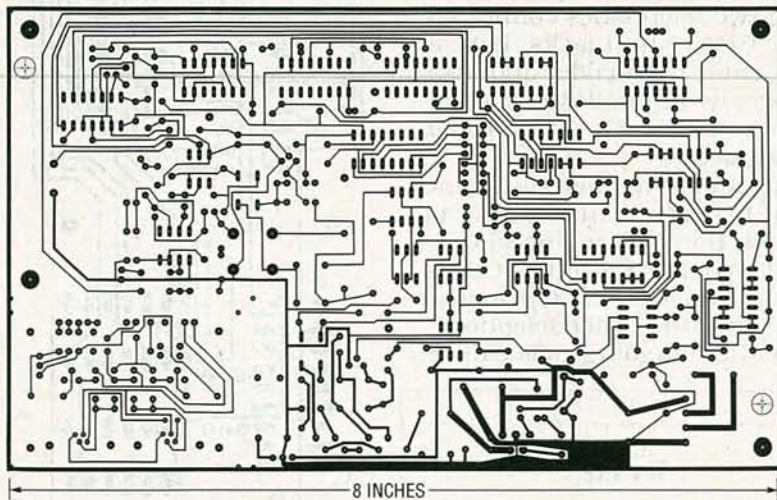

SOLDER SIDE of the main circuit board, shown here at half of its actual size.

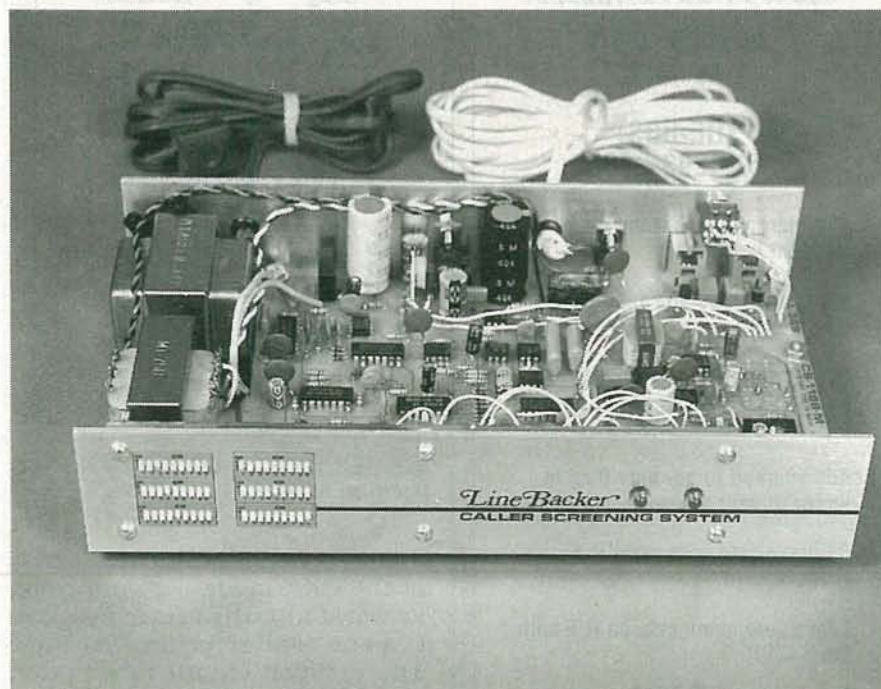

FIG. 5—THE SIX DIP SWITCHES and the two screen-status indicators (LED1 and LED2) must be mounted on the solder side of the front-panel board so that they can protrude through the cutouts on the cabinet.

## ORDERING INFORMATION

Note: This information supersedes that presented last month. The following is available from Electronic Control Systems, R.D. 2 Box 3308, Wernersville, PA 19565: A set of two double-sided, plated-through PC boards for \$39.95 (add \$2.00 postage and handling); a complete kit including PC boards and all parts except the cabinet for \$139.00 (add \$3.50 postage and handling). Pennsylvania residents add 6% sales tax to all orders; check or money order only.

finished they are connected together and mounted at a right angle to each other in the cabinet. But remember to inspect all wiring and solder joints for poor or non-existent connections before doing so. All interconnections between the two boards should be made with fine gauge hook-up wire (AWG 30) to reduce mechanical stress on the boards during assembly. The boards may be installed in any type of cabinet the builder wishes. If the LED indicators are panel mounted and the code-select DIP switches are replaced with hard wire jumpers, then the front-panel board can be mounted anywhere inside the cabinet.

The two power IC's (IC19 and IC26) must be heat sunk. Their location on the PC board allows them to be bolted directly to the cabinet wall using 6-32 hardware. (Make sure that the nuts used are not so large that the IC cases crack when tightened against the tabs). Both IC heat-sink tabs are at ground potential so they do not require insulating. If a plastic cabinet is used, a strip of aluminum sheet metal may be mounted to the tabs as a heat sink. The majority of heat generated occurs when the screener is ringing telephones, so large sinks are not needed. A 1- $\times$ -5-inch strip of aluminum should be sufficient.

### Power-up

Set the ring-voltage potentiometer (R51) to an initial 10-O'Clock position. If possible, adjust the ring voltage to 90 volts using a DMM and an REN load of 1.0. If the CRA is used, make sure it is switched off. Connect the Call-Screen to a phone line. Lift the receiver and check for a dial tone.

Connect an ohmmeter across



Put Professional Knowledge and a  
**COLLEGE DEGREE**  
 in your Technical Career through  
**HOME STUDY**

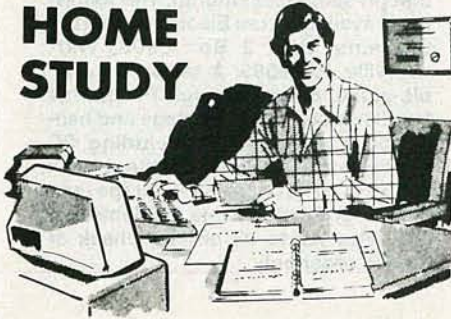

Add prestige and earning power to your technical career by earning your Associate or Bachelor degree through directed home study.

Grantham College of Engineering awards accredited degrees in **electronics and computers.**

An important part of being prepared to *move up* is holding the right college degree, and the absolutely necessary part is knowing your field. Grantham can help you both ways—to learn more and to earn your degree in the process.

Grantham offers two degree programs—one with major emphasis in **electronics**, the other with major emphasis in **computers**. Associate and bachelor degrees are awarded in each program, and both programs are available completely by correspondence.

No commuting to class. Study at your own pace, while continuing on your present job. Learn from easy-to-understand lessons, with help from your Grantham instructors when you need it.

Write for our free catalog (see address below), or phone us at toll-free 1-800-955-2527 (for catalog requests only) and ask for our "degree catalog."

Accredited by  
 the Accrediting Commission of the  
 National Home Study Council

**GRANTHAM**  
**College of Engineering**  
 250 Frontage Road  
 Slidell, LA 70460

the +5-volt supply line and make sure that no low resistances exist (less than 1K). Similarly, check the +16-volt supply line for any resistance under 15K. Connect a DC voltmeter across the 5-volt supply, power up the unit, and check for the proper voltage. Also check the 16-volt supply; under idle conditions it should read close to 18 volts.

Lift the receiver of the telephone and check for screen mode changes using the "#" and "\*" keys. Leave the screen mode in "Limited Screen" (one LED lit). Note that screen mode changes via a connected phone are allowed for only seven seconds following an off-hook transition. Using two telephones connected to the CRA output jacks, have a caller enter each code, and also no code, with the CRA in each of its two modes. Verify that call routing occurs.

In a similar manner, cause one phone to ring but answer the call through the non-ringing phone. Verify that the incoming call is properly answered. Repeat the step using the other telephone. Verify that outgoing calls can be

Try the  
**Radio Electronics®**  
 bulletin board system  
 (RE-BBS)  
 516-293-2283

The more you use it the more useful it becomes.

We support 300 and 1200 baud operation.

Parameters: 8N1 (8 data bits, no parity, 1 stop bit) or 7E1 (7 data bits, even parity, 1 stop bit).

Add yourself to our user files to increase your access.

Communicate with other R-E readers.

Leave your comments on R-E with the SYSOP.

RE-BBS  
 516-293-2283

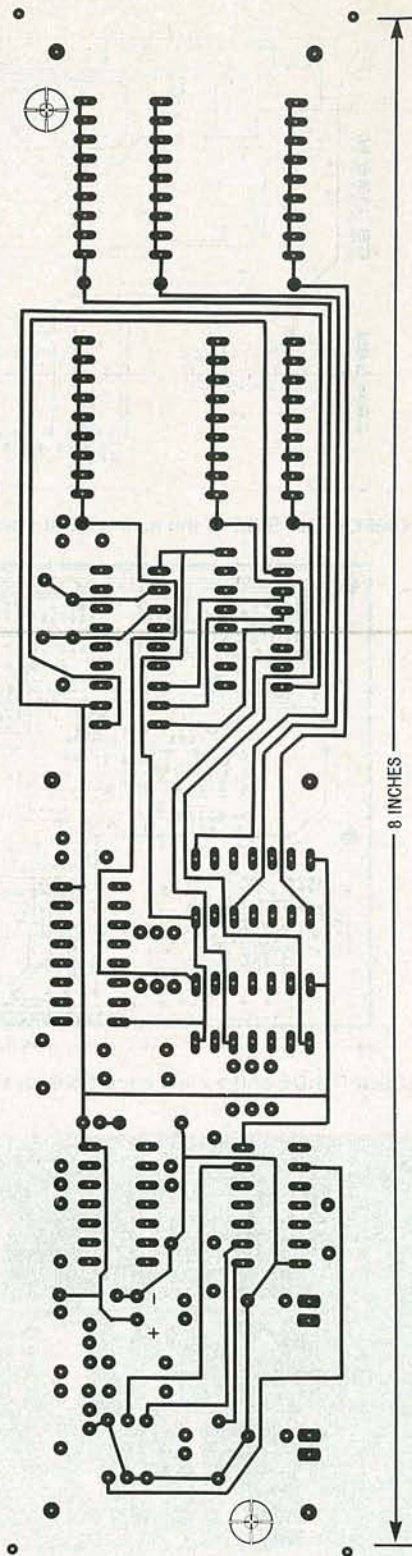

SOLDER SIDE of the front-panel PC board, at full size.

made by either phone regardless of the CRA mode. Be sure to review last month's article for a discussion of all screening features. The detailed circuit description should help you to troubleshoot any problems. Then you're ready to give out your access codes! R-E



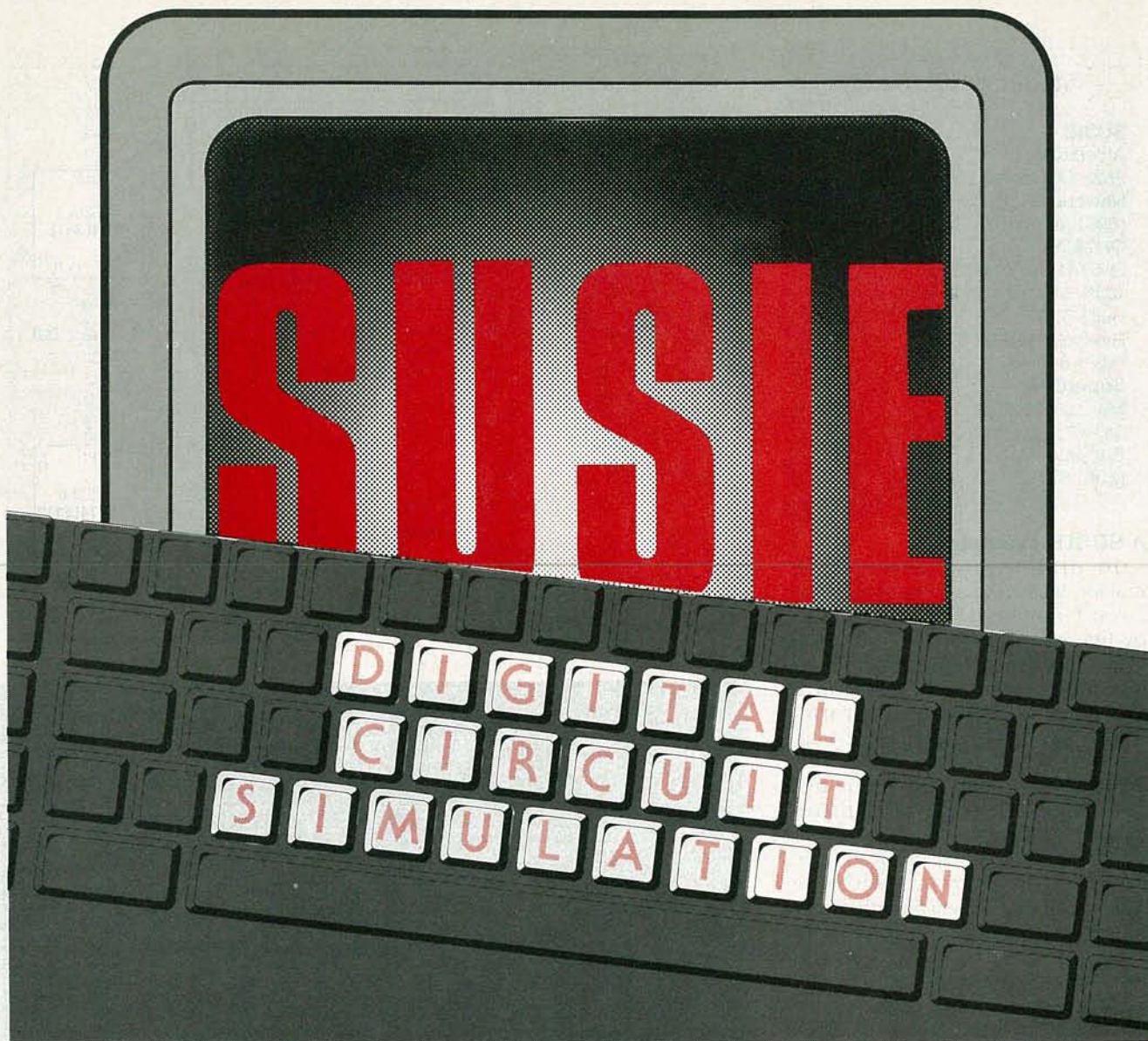

***SUSIE simplifies digital design, and makes breadboards a thing of the past.***

**TJ BYERS**

DESIGNING DIGITAL CIRCUITS MAY look like child's play, but the journey from inspiration to a functional circuit is fraught with peril. Propagation delays, glitches, timing violations, and bus conflicts can turn a simple idea into a nightmare.

The traditional method of testing a digital design is to breadboard the circuit, then drag out the logic probe, oscilloscope, and logic analyzer to find out why it doesn't work. The modern method is to simulate the design on an IBM-compatible PC using a program called SUSIE (standard universal simulator for improved engineering), made by a company called Aldec.

**If you knew SUSIE**

SUSIE is a simulation program that graphically depicts the timing and logic events of a digital circuit. Although SUSIE uses software to verify the design, the results are the same as if you had built the circuit and used an ultra-sophisticated logic analyzer to test and debug it.

SUSIE simulates the operation of logic IC's using mathematical models stored in a library. IC models include algorithms for setup and hold time, pulse width, edge-to-edge transfer delay, and other propagation parameters.

There are different libraries for different types of components, with one library for TTL devices, another for CMOS, yet another

for ECL, and so on. SUSIE comes with those three libraries, plus two additional libraries containing switches and other passive components. Aldec's Model Builder Compiler (MOBIC) allows you to model IC's that are not included in the libraries. You can also purchase extra libraries for devices including memory IC's, microprocessors, gallium-arsenide (GaAs) logic, programmable logic devices (PLD's), and gate arrays, plus libraries for computer interfaces and industrial components like stepper-motor controllers. The optional libraries cost between \$800 and \$2,000. However, you can do a lot with the nearly 6000 devices that come standard with the basic SUSIE package.



## PRODUCTS MENTIONED

### SUSIE

Aldec Co.  
3525 Old Conejo Rd. #111  
Newbury Park, CA 91320  
(805) 499-6867

### OrCAD

OrCAD Systems Corp.  
1049 S.W. Baseline St.  
Suite 500  
Hillsboro, OR 97123  
(503) 640-9488

### SuperCAD

Mental Automation  
5415 136th Place S.E.  
Bellevue, WA  
(206) 641-2141

## A SUSIE example

To understand how SUSIE works, let's take an example. The circuit shown in Fig. 1 is a divide-by-five counter with a 50% duty cycle output. Ordinary divide-by-5 counters produce an asymmetric output with a 20/80 timing ratio, but by using a negative edge-triggered flip-flop and half-state timing, we can make a divide-by-five counter with a 50/50 timing ratio.

Three counter stages are needed to divide by five, with one driven on the inverted clock to compensate for the odd number of states. That is, to achieve the sixth state needed to produce a 50% duty cycle, IC1-b must change state on the negative edge of the clock at  $t=2.5$ , and that can be forced by timely triggering of the flip-flop's PRESET input (pin 10).

Debugging a circuit like that in hardware could get quite thorny. Let's see how SUSIE handles the situation.

## Design entry

SUSIE's design verification process is divided into three steps: design entry, test vectors, and simulation. During design entry you load and define the section or sections of the circuit you want to display on the screen. SUSIE can show as much or as little of the design as you wish. You can zoom in on a single IC or display waveforms for every point in the circuit.

Design entry begins with a *netlist*. The netlist contains a list of all the components in the circuit and their connections to one

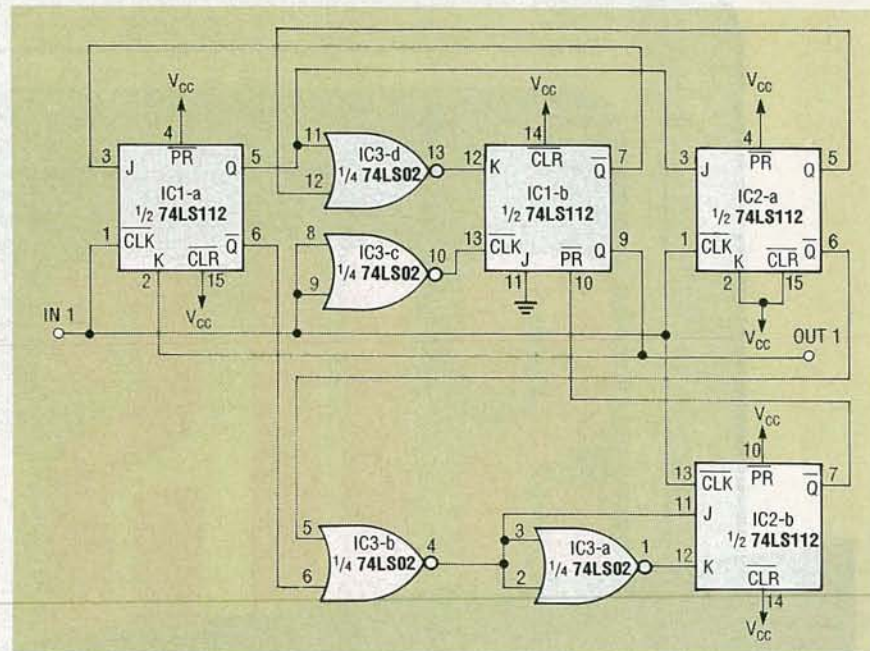

FIG. 1—DIVIDE-BY-FIVE counter with a 50% duty cycle output.

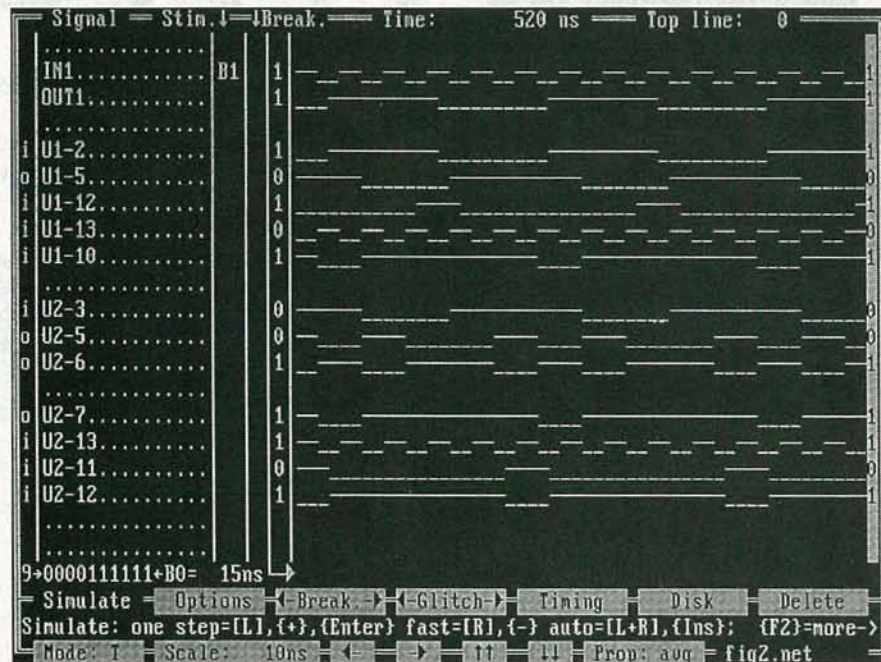

FIG. 2—SUSIE SIMULATION of the divide-by-5 counter shown in Fig. 1.

another. SUSIE reads the netlist, downloads the specified components from their libraries, and "builds" the circuit in RAM. (See the sidebar, "Writing A SUSIE Netlist," for more information about netlists.)

After SUSIE loads the netlist, you define which part(s) of the design you want to view by listing pin numbers or node names in the signal column on the left side of the display screen. For example, in Fig. 2, we defined several nodes (IN1, OUT1) and various

pins of IC1 and IC2 for display.

Note that we selected no pins from IC3, and only some from IC1 and IC2. The reason is that too much information can be more confusing than not enough. The point is that, regardless which nodes are displayed, the entire circuit is tested during simulation, and all questionable timing events (glitches, etc.) are brought to your attention.

Of course, after creating a design, you can save it to disk and load it again later.



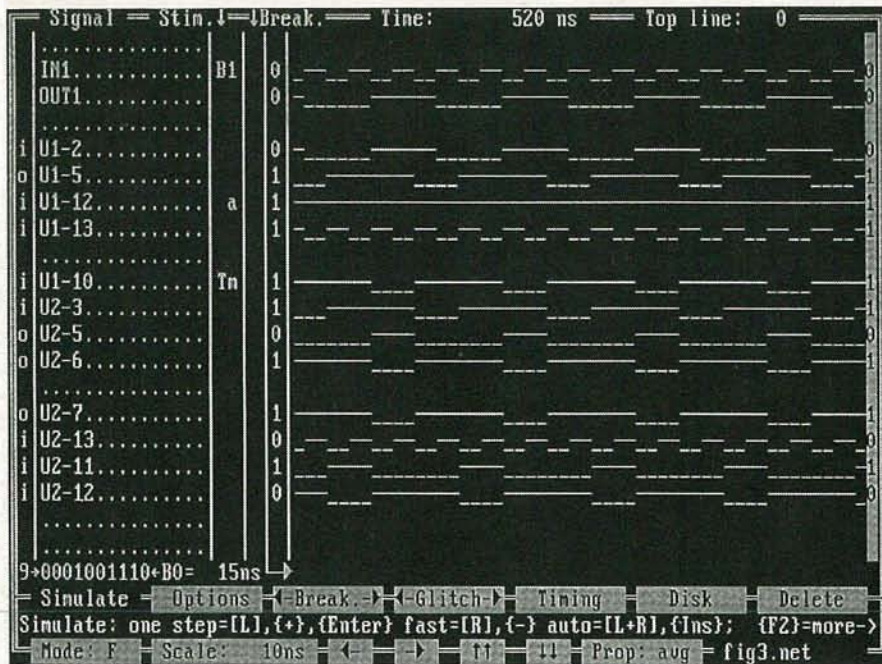

FIG. 3—DIVIDE-BY-THREE counter created by changing the test vector on pin 10 of IC1 to pull pin 12 high. The original circuit (Fig. 1) becomes a divide-by-3 counter with a 50% duty cycle.

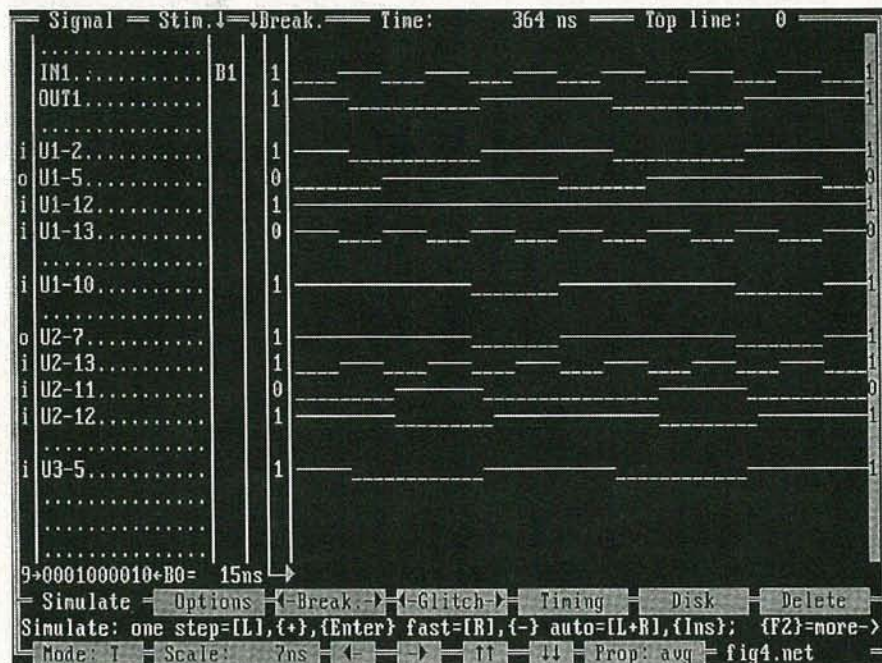

FIG. 4—SUSIE SIMULATION of the complete divide-by-3 counter.

### Test vectors

For a design to function, it must have some kind of input; SUSIE's inputs come from *test vectors*. A test vector is nothing more than a waveform that, when applied to an input, causes something to happen in the circuit. SUSIE can serve up an almost limitless variety of test vectors.

You create test vectors using ei-

ther an ASCII text editor or SUSIE's built-in test-vector editor. Test vectors may be stored in either a compressed binary format or one of three ASCII formats. The ASCII versions differ both in the format of the file and in the way it is used.

- The *line version* is formatted as a string of 1's (high) and 0's (low) that establishes the timing and shape of the waveform. Each line

in the file represents one waveform, and you may describe and load as many lines (waveforms) as you wish.

- The *bus file* is similar to a line file, except that it is written in hexadecimal notation, and is used primarily to define waveforms for an entire bus.

- The *waveform file* consists of statements written in Aldec's proprietary high-level language, and it can be used to create waveforms too complex for the other methods.

To use SUSIE's built-in editor, you simply place the cursor over the signal to be edited and manually key in the desired waveform. After the test vector appears satisfactory, you can save it to a line or bus file directly from the screen. However, test vectors created on the screen using Aldec's programming language cannot be saved to a file; you can retain such files only by creating them first with a text editor.

After defining and naming a test vector, you can load it into any netlist design entry. Although a test-vector file may contain any number of waveforms, only one file may be loaded at a time.

SUSIE also has an internal ten-stage binary counter that can be used along with a test-vector file

### OBTAINING SUSIE

As digital circuit-simulation programs go, SUSIE is a real bargain. But at \$995 (optional libraries not included), it's too pricey for the average hobbyist.

Fortunately, Aldec offers a free SUSIE demo disk that does everything the full-blown SUSIE package does, but on a smaller scale. Instead of 6000 devices, the demo contains 26 logic devices and seven PLD's, plus a full complement of switches and passive components.

Although the demo disk can't simulate every digital design situation, the logic types are varied enough that, with prudent part selection, you can test a wide variety of design types—for free. Table 1 lists the IC's supported by the demo disk. The letters xx stand for any logic technology, ie. LS, AS, F, etc. IC models include set-up and hold time, pulse width, edge-to-edge and other propagation delay parameters.

R-E



**TABLE 1—DEMO DISK SUPPORTED COMPONENTS**

74xx00	Quad 2-input NAND gate
74xx02	Quad 2-input NOR gate
74xx04	Hex inverter
74xx05	Hex inverter (OC)
74xx07	Hex buffer (OC)
74xx08	Quad 2-input AND gate
74xx10	Triple 3-input NAND gate
74xx11	Triple 3-input AND gate
74xx20	Dual 4-input NAND gate
74xx30	8-input NAND gate
74xx74	Dual D-type flip-flop
74xx85	4-bit magnitude comparator
74xx86	Quad 2-input XOR gate
74xx90	BCD decade counter
74xx138	3-of-8 decoder
74xx151	8-input multiplexer
74xx153	Dual 4-input multiplexer
74xx157	Quad 2/1 multiplexer
74xx161	Presetable binary counter
74xx175	Quad D-type flip-flop
74xx193	BCD up/down binary counter
74xx244	Octal driver Three-state
74xx245	Octal bus transceiver
74xx279	Quad S-R latch
74xx373	Octal transparent latch
74xx374	Octal D-type flip-flop three-state
10H8	PLD
16L8	PLD
16R4	PLD
20L8	PLD
20L10	PLD
22V10	PLD
32VX10	PLD

analysis. You can preset any design element to an initial logic state, search for timing glitches, and set breakpoints for incremental timing measurements.

Most simulations use the internal binary counter for the signal source, as we did for our test design in Fig. 1. The counter has ten stages (B0 through B9), each of which is half the frequency of the preceding stage. The pulse width of B0 is adjustable between 10 picoseconds and 999 seconds. For our simulation, we set B0 at 15 ns and used B1 (30 ns) as the clock. The resulting display is shown in Fig. 2, which we will now use to verify our design.

At power up ( $t=0$ ), the output of IC1-b (pin 9) is set high. On the first clock pulse, the input to pin 13 goes negative, causing the flip-flop to toggle and force pin 9 low and pin 7 high. That sets the stage for IC1-a to reset on the falling edge of the same clock pulse, which in turn causes pin 12 to go low and prevents further clock pulses from affecting IC1-b.

However, IC2-a continues to toggle, sending signals to IC2-b until its inputs reach a logical combination (pin 11 high, pin 12 low) that causes the inverted output (pin 7) to go low on the falling edge of the third clock pulse. That forces IC1-b's preset input (pin 10) low and output (pin 9) high. A half state later, IC1-b's new logic state forces IC2-b's pin 11 input low. That releases the hold on IC1-b and enables the counter to function as a normal state machine until the forced state is reached again. The resulting waveform at OUT1 shows us that our design does indeed work as predicted.

### Using SUSIE to modify a design

Unlike many analog and digital simulators, SUSIE doesn't need to compile the netlist before it can do a simulation, and that makes it possible to change test vectors and circuit connections without having to change the netlist.

For example, let's say that we wanted to modify our design so that it was a divide-by-3 counter instead of a divide-by-5 counter. That is easily done using SUSIE's on-screen editing features.

Looking at the timing screen in Fig. 2, we see that in order to pull

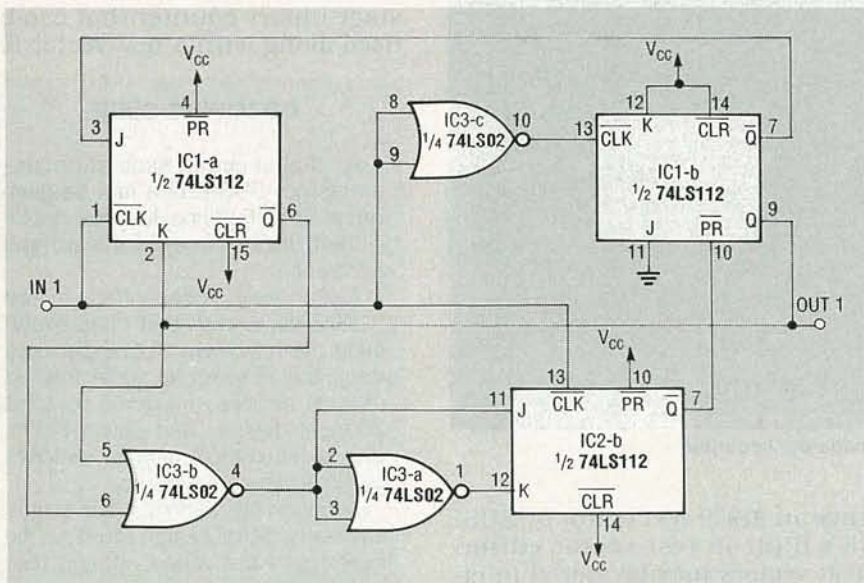

**FIG. 5—FINAL SCHEMATIC of the divide-by-3 counter.**

as a square-wave signal generator or as a frequency divider for other test vectors.

### Simulation

Circuit simulation is the third and final step in the simulation

process. It is where you get to see what happens in the circuit as a result of the applied inputs. It's also where you learn whether or not your design will fly.

The simulation mode provides numerous features that simplify



## LISTING 1—NETLIST OF DIVIDE-BY-3 COUNTER

```
sockets u1 = 74LS112
sockets u2 = 74LS112
sockets u3 = 74LS02

/in1, u1/1, u2/13, u3/8, u3/9 ;signal input
/out1, u1/2, u1/9, u3/5 ;divide-by-3 out
u1/3, u1/7
u1/6, u3/6
u1/10, u2/7 ;U1b preset
u1/13, u3/10
u2/11, u3/2, u3/3, u3/4
u2/12, u3/1
/GND, u1/8, u2/8, u3/7, u1/11
/VCC, u1/16, u2/16, u3/14, u1/4, u1/15, u1/14, u1/12, u2/10, u2/14
```

## WRITING A SUSIE NETLIST

Like all circuit-simulation programs, SUSIE uses a netlist to define the circuit. However, unlike many circuit simulators, which require special tools to create the netlist, SUSIE's netlist is in pure ASCII, which means all you need to make a SUSIE netlist is a text editor.

The process begins with a schematic of the design. (Refer to Fig. 1 in the text for this discussion.) First, the circuit's inputs, outputs, and components are identified by name and number. Those labels are then entered into the netlist using the format: *sockets schematic label = device type*. The order of the parts is really immaterial.

Next, connections between devices are listed by component label and pin number, with a comma separating each entry. Again no special order is necessary, and comments

(placed after a semicolon) can be inserted in the netlist to help describe large designs. Signal inputs, outputs, and power-supply connections are preceded by a slash.

A separate line is required for each node in the circuit (a node is any point where two or more pins or wires connect). However, if the number of connections to a node is greater than will fit on a line, the listing can extend to the next line by ending the first line with an "&" character. There is no limit to the number of lines you can use for a single node, provided the lines are in sequence and linked via the "&" character.

That's all there is to it. The netlist shown in Listing 2 is ready for simulation. Several schematic-capture programs, including OrCAD and SuperCAD, can generate a SUSIE netlist directly from a screen schematic. **R-E**

## LISTING 2—NETLIST OF DIVIDE-BY-5 COUNTER

```
sockets u1 = 74LS112
sockets u2 = 74LA112
sockets u3 = 74LS02

/in1, u1/1, u2/13, u3/8, u3/9, u2/1 ;signal input
/out1, u1/2, u1/9 ;divide-by-5 out
u1/3, u1/7
u1/5, u2/3, u3/11
u1/6, u3/6
u1/10, u2/7 ;U1b preset
u1/12, u3/13
u1/13, u3/10
u2/5, u3/12
u2/6, u3/5
u2/11, u3/2, u3/3, u3/4
u2/12, u3/1
/GND, u1/8, u2/8, u3/7, u1/11
/VCC, u1/16, u2/16, u3/14, u1/4, u1/15, u1/14, u2/4, u2/15, u2/2, u2/10, u2/14
```

this off we have to force the break at  $t=1.5$  instead of at  $t=2.5$ . We can test our theory by applying a custom-made test vector to pin 10 of IC1-b.

The test vector can be created in several ways, but the best method for our situation is to use the Aldec programming language. First we look at the display to determine where the changes must occur. For our application, the test vector must have eight high pulses followed by four low pulses. The Aldec equation for that waveform is (H8L4)100, where H8 specifies eight highs, L4 specifies four lows, and 100 indicates that the preceding pattern should be repeated one hundred times. The repeat gives us plenty of time to play with the circuit before running out of signal.

To perform the modified simulation, we load the original design into SUSIE and apply the test vector to pin 10 of IC1-b (Fig. 3). Analysis of the timing display shows that pin 12 of IC1-b needs to be tied high so that IC1-b isn't affected by IC2-a. You could go into the netlist and change pin 12's connections, but SUSIE's editor lets you assign IC pins or nodes to keyboard keys that manually override the design stimulus. In our case, we assigned the *a* key to pin 12, then toggled the input high for the simulation. The result of this simulation, shown in Fig. 3, shows that our assumptions were correct and that the new design does work: For every three input pulses, the circuit produces one output pulse, and the duty cycle is 50%. The netlist for that circuit is shown in Listing 1.

The next step is to alter the circuit so that it generates the test vector itself. This can also be done in SUSIE using *connectivity markers*—screen notations that tell SUSIE to make a connection between like markers. As it turns out, the only change we have to make in the original design is move pin 5 of IC3 from IC2-a to pin 9 of IC1-b using the "aa" connectivity markers shown in Fig. 4. The rules for connectivity are: If you mark an input for screen connectivity, all previous connections to the input are severed; if you mark an output for screen



connectivity, it serves the new source plus all the original sources.

Next we disconnect the Aldec test vector and run a new simulation, as shown in Fig. 4. Once again, the simulation verifies the circuit changes. A revised schematic of the new divide-by-three counter is shown in Fig. 5.

### Advanced features

SUSIE also has a host of advanced features that are used to pinpoint design defects, test for worst-case conditions, and input data from or output it to the real world. Here is a brief description of each advanced feature.

- Switches placed in the circuit can be opened and closed from the simulation screen, making "what-if" and alternate-configuration designs a snap to verify.
- The timing selection allows you to set IC propagation delays to any value for worst-case evaluation. You can also change IC technology (for example, from LS to AS), save and load IC propagation data files, and include the effect of temperature and loading on the simulation.
- Glitches that occur as a result of propagation delay, timing violations, or floating inputs are automatically displayed and pinpointed—even if the pin involved isn't part of the simulation display.
- Bus conflicts, where two or more outputs vie for simultaneous use of the bus, automatically produce a warning message that can be used to pinpoint the conflicting signals.
- Fault simulation, which shows all stuck inputs and outputs, is available as an option. To speed the lengthy process of fault simulation, SUSIE lets you divide the job among an unlimited number of unconnected PC's.
- Hardcopy printout of screen simulations can be made using either a dot-matrix or laser printer. The logic analyzer option lets you feed test vectors from a hardware design (breadboard or PC board) to SUSIE for analysis and debugging.

While SUSIE's simulation powers make it an attractive alternative to breadboarding, its real strength is that it lets your creative talent run free—without any physical restrictions. R-E

# Radio Electronics® mini-ADS

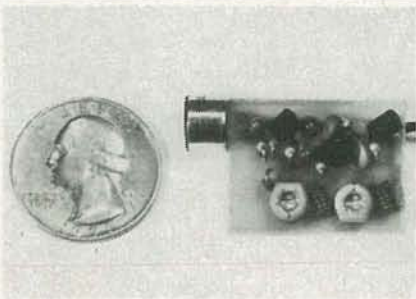

**SIMPLY SNAP THE WAT-50 MINIATURE FM TRANSMITTER** on top of a 9v battery and hear every sound in an entire house up to 1 mile away! Adjustable from 70-130 MHZ. Use with any FM radio. Complete kit **\$29.95 + \$1.50 S + H**. Free shipping on 2 or more! COD add \$4. Call or send VISA, MC, MO. **DECO INDUSTRIES, Box 607, Bedford Hills, NY 10507. (914) 232-3878.**

CIRCLE 127 ON FREE INFORMATION CARD



**GET YOUR RECHARGE CATALOG FREE...EARN BIG \$\$ IN YOUR SPARE TIME**—All supplies and Do-It-Yourself kits with complete instructions available. Supplies cost from **\$9.95** in qty and you can sell recharged toner cartridges for **\$40.00 to \$55.00** each. Printers include HP LaserJet and Series II, Apple LaserWriter, QMS, etc. Canon PC-25 Copier also. **CHENESKO PRODUCTS, 62 N Coleman Rd., Centereach, NY 11720, 516-736-7977, 800-221-3516, Fax: 516-732-4650**

CIRCLE 187 ON FREE INFORMATION CARD



**CABLE TV CONVERTERS AND DE-SCRAMBLERS** SB-3 **\$79.00** TRI-BI **\$95.00** MLD-**\$79.00** M35B **\$69.00** DRZ-DIC **\$149.00**. Special combos available. We ship COD. Quantity discounts. Call for pricing on other products. Dealers wanted. **FREE CATALOG**. We stand behind our products where others fail. One year warranty. **ACE PRODUCTS, P.O. Box 582, Saco, ME 04072 1 (800) 234-0726.**

CIRCLE 75 ON FREE INFORMATION CARD



**THE MODEL WTT-20 IS ONLY THE SIZE OF A DIME**, yet transmits both sides of a telephone conversation to any FM radio with crystal clarity. Telephone line powered - never needs a battery! Up to ¼ mile range. Adjustable from 70-130 MHZ. Complete kit **\$29.95 + \$1.50 S + H**. Free Shipping on 2 or more! COD add \$4. Call or send VISA, MC, MO. **DECO INDUSTRIES, Box 607, Bedford Hills, NY 10507. (914) 232-3878.**

CIRCLE 127 ON FREE INFORMATION CARD



**NEW XST500 SUPER-MINIATURE FM** transmitter uses Surface Mount Technology (SMT)! Own the smallest high performance FM transmitter available. Transmits whispers to any FM receiver up to a mile away. Uses 9V battery. Complete, easy to assemble kit, with SMT components already assembled to circuit board. **\$39.95** Cash, VISA, MC. COD add \$5. **XANDI ELECTRONICS, 201 E. Southern Ave., Suite 114, Tempe, AZ 85282. 1-602-829-8152, (1-800-336-7389 orders only).**

CIRCLE 183 ON FREE INFORMATION CARD

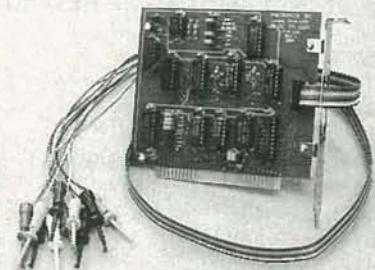

**LOW COST PC LOGIC ANALYZER (Model LA1—\$99.95)**. Ideal for students and hobbyists working with digital logic in the KHz range. Designed for non-microprocessor applications—works where an oscilloscope, DVM, and logic probe are inadequate. 8 channels, 36" data cable, 5V TTL/CMOS input, intex clock, full-featured graphics, utilities, etc. Over 100,000 samples/second on 12 MHz PC. Demo pak: \$4. **PHOTRONICS, P.O. Box 219, Greensburg, LA 70441, (504) 222-4146.**

CIRCLE 197 ON FREE INFORMATION CARD



FOR A TEST TECHNICIAN OR ENGINEER, using test leads with a multimeter may be an everyday experience. Those of you who use multimeters on a consistent basis know how important it is to use the right kind of test lead, probe and probe tip. Those less experienced might be inclined to use any old probe. We'll show you why that's not a good idea, and then we'll take a look at what's currently available to help you make the right decision in choosing your test probes.

### The basics

There are four basic requirements that determine the quality of a good test lead. Those requirements are:

- Reliability—the test lead should bite through the oxide, dirt, corrosion and insulation or conformal coating to make good contact with a lead, test point or wire.
- Hold the connection—the test lead should keep a continuous, nonintermittent contact.
- Dependability—the test connection must be insulated from other devices or equipment, and the connections shouldn't pull loose. That's a particularly frustrating problem, especially when you're forced to stop testing several times to reconnect the leads. A "hot" lead swinging loose can also be a danger, which leads us to the next point.
- Safety—testing can be inherently dangerous in many cases, so it's important that the equipment be as safe as possible.

Those four points aren't listed in order of priority; they are interdependent necessities. A good contact doesn't accomplish anything if you have 1500 volts hanging loose! With those four basic requirements in mind, we'll take a look at different probe tips, which actually make the test contact, as well as body design and interconnections.

### Types of probe tips

One of the most commonly used tips is the brass-notched type, shown in Fig. 1-a. That type of tip is normally a 0.08-inch diameter brass rod, an inch or less

\*Bill Hansen is an engineering supervisor for ITT Pomona, a company specializing in test lead kits and accessories for digital multimeters.

# CHOOSING THE RIGHT TEST PROBE

BILL HANSEN\*

*Here's some help  
in choosing  
the right probe  
for your  
testing needs.*

DECEMBER 1990



in length, with a conically-shaped arrow-head on the end. Brass is a good current conductor with a very low voltage drop across the contact point. It's relatively soft so it can conform to the test point with some grab, and not slide away too easily. In addition, the notch can lock onto a lead or wire, if that's what you're testing. The notched tip is small enough to fit into tight spaces and can handle most loads it's subjected to.

A dog-leg microtip, shown in Fig. 1-b, is useful for probing high-density PC boards that use surface mount technology (SMT). It lets you dodge around components and provides a "springiness" that enables you to move the probe handle slightly without losing your contact point. Extendable versions allow you to reach several inches down into a circuit, perhaps to get around a power supply or other object. Since these long, thin tips are insulated, they are not likely to cause shorts.

A sharp needle-point tip, shown in Fig. 1-c, offers a lot of advantages. A sharp tip can penetrate oxides or insulation easily and makes a good connection. It's made of stainless steel so it's strong, even springy, and easy to handle. The sharpness of the point digs in and grabs hold of the test point, and tends to stick and not slide off. One drawback is that steel is not the best conductor, and the sharp point means you can't drive too much current through it or it will burn up.

A shouldered microtip, shown in Fig. 1-d, provides a very small needle point, which is ideal for piercing insulation, while leaving only a very small hole.

The IC leg, shown in Fig. 1-e, is a specialty tip, which is a sharp needle point protected by insulating plastic on each side. As with the needle points, it digs in and holds in place while the insulation protects against shorts. This is an excellent probe tip for contacting IC leads.

Alligator clips, shown in Fig. 1-f, are perhaps the most common. Nobody likes alligator clips but everyone uses them. Because of their size, they don't fit into tight spaces very well. The clip's weight acts as a lever that tends to pull

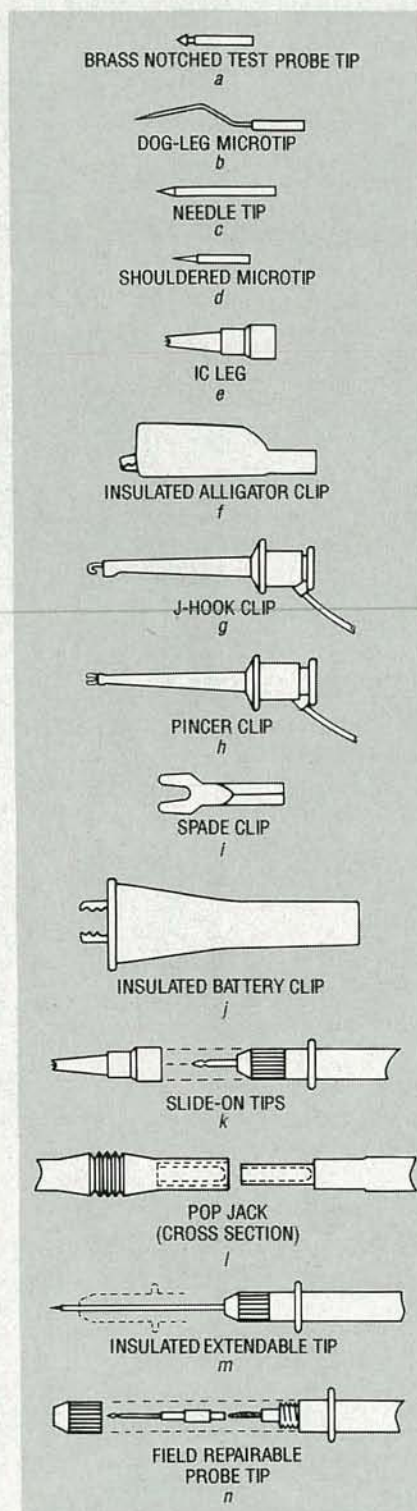

**FIG. 1—EACH OF THESE PROBE TIPS HAS THEIR OWN distinct advantage when used in a specific testing application. All of these probe tips should meet most of your testing needs.**

itself loose. Their jaws tend to be out in the open, contributing to inadvertent contact with neighboring objects, unless they are sheathed. Alligator clips come in different sizes and, in the right applications, they are useful.

J-hooks, with a spring-loaded insulation sheath, can really grab a component lead or wire and hold on well. That type of probe tip is shown in Fig. 1-g. They come in maxi, mini, and micro sizes to adapt to different jobs. Gold-plated beryllium-copper alloy makes an excellent contact. Don't accept J-hooks of base metal; the savings aren't worth it. The spring-loaded sheath is a safety factor as well as a mechanical aid for a good hold. Their advantages are obvious. The disadvantage is a slightly higher price than straight tips. In very close quarters, with tightly spaced component leads, J-hooks can also present a size problem.

Pincers, shown in Fig. 1-h, were designed as a J-hook replacement for use in tighter spaces. The "U" shaped tips are gold-plated beryllium copper and are heat treated to act as a spring. They reach around and grab onto component leads. Again, a spring loaded sheath provides a safety advantage and protects against shorting to adjacent leads. The disadvantage of a pincers tip is that they are more expensive than simpler straight tips.

Spade lugs, shown in Fig. 1-i, can be screwed down at a binding post, giving you the advantage of hands-free operation to turn on power, throw your switches and make your measurements. In specific applications they let you hook one or both sides of your multimeters and not worry about making or keeping contact.

The battery clip, shown in Fig. 1-j, was not really designed for batteries, but is the common descriptive name used in industry. It lets you grab onto large nuts or bolts and holds on strong.

### Probe design

Many of the tips we have described are available permanently installed in special purpose probes. Some are available as "slide on" tips (Fig. 1-k), which allow a common probe body to be interchanged with a variety of probe tips and some with "pop-jack" connections (Fig. 1-l) to plug into a common probe body.

Permanently connected probe tips offer advantages to anyone who often or repetitively performs the same test step. You just



pick up your sturdy probe and do the job. The disadvantage is a lack of versatility. Either you'll have to try and "make-do" with the wrong probe occasionally or you'll have to buy a number of different probes to meet each situation. In fact, if you do a large amount of testing, having a collection of probes to meet each situation is a wise decision. A number of kits of probes selected to match various applications are available at good prices.

Slide-on tips give you versatility. You can use a needle-sharp tip when you need it, and a spade-lug when your need changes. They provide big advantages to anyone that usually works with high-voltage equipment and only occasionally with low voltage.

A particularly useful slide-on tip is the insulated extendable tip shown in Fig. 1-m. The extendable tip is able to get into those deep, hard-to-reach spaces without the worry of shorting of nearby components.

The disadvantage of slide-on tips is an outgrowth of the advantage—the slide-ons can also slide off. The pop-jack connection offers a solution to that problem. It allows you to interchange probe tips but holds them in place tighter. It offers a metal male-female connection with a friction grab, plus the plastic insulating sheaths actually deform and create a seal. The pop-jack connection requires five or more pounds of pull to dislodge it, although if you twist it first, it parts easier. It's somewhat like a Chinese finger puzzle in its holding ability.

### Field repair

Test probes that are field repairable have a distinct advantage over those that are not. Most test probes that are non-field repairable are insert molded, with the test leads permanently embedded in the handle. That method of construction can present several problems. Most problems occur when the lead wire frays where it enters the handle. Once that happens, the probe must be discarded and replaced.

There can also be a safety hazard during the manufacturing process. A stray wire can sometimes occur at the tip-and-lead

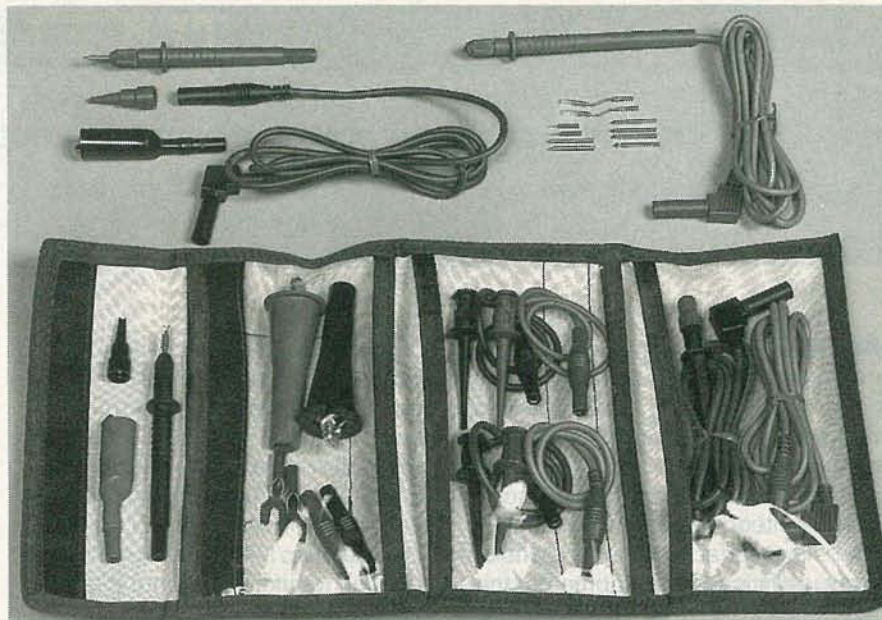

**POMONA'S MAXI-KIT CONTAINS** a wide assortment of probes for the professional DMM user.

junction on the test probe, which is usually a crimp. When molded into a handle, that stray wire can be very close to the surface of the probe and, particularly at high voltages, presents a serious shock hazard.

At Pomona, the tip-and-lead-wire assembly is threaded into a hollow handle and the tip is then held in place with a screw-down chuck. Therefore, it will never short through to the probe handle, and the probe is actually field repairable. If the lead wire is bent, broken or frayed, you cut it off and re-solder the wire to the tip, insert it back into the handle and chuck it in place. Figure 1-n shows a drawing of a field repairable probe tip.

### Connections

Connection of the probe to the multimeter is through wire and a standard banana plug. The wire must be properly insulated and have a low enough resistance to adequately pass signals. Pomona test leads use double-insulated, 18-gauge wire, which more than meets all product safety requirements. Various insulating materials include: standard PVC, a superior PVC that's more flexible, or silicone, which is both more flexible and much more resistant to high temperatures, which is usually a problem when using a soldering iron.

There's more to a banana plug than you might think. High-

quality banana springs are made of a single piece of heat treated, spring quality, beryllium copper. Most banana plugs on the market, however, are made of materials with bus spring retention, which makes less dependable and less reliable connections.

Uninsulated banana plugs are still available for multimeters, but the move is away from them, which is all for the better. A bare, uninsulated plug swinging loose while "hot" is just too dangerous to accept. For safety reasons, we urge you to use insulated plugs.

Most users, after they finish testing, wrap the leads around the meter and put them away until the next time. That means the leads are getting bent at a 90° angle, banged against a drawer or shelf, and eventually tend to break or fray. Leads that are molded at 90° from the sheathed plug will prevent that problem.

### Wrap up

Multimeter manufacturers have a bad reputation for test leads. The fact is, your meter probably doesn't come with the best selection of leads for your specific needs. Typically, you should plan on investing some money on additional test leads.

Testing can be inherently dangerous, particularly at higher voltages. The closer you get to having the correct tool for each task, the safer and easier it is to perform your testing.

R-E

eptember  
mply latch-  
l thanks to  
me all of  
ts to try.  
his month.

### update

ors called  
es. Instant  
on com-  
ust about  
part to a  
riend to a  
h.  
ustry goes  
Prototyping  
r, all these  
producing  
crude sold-  
d range of  
l notice a  
your roast

nities here  
off, today's  
obscenely  
best possi-  
early does  
crude ap-  
bird, and fi-  
of service  
hise oppor

p prototyp  
ou can now  
ok-on-De  
you should  
ate virtually  
b, at pretty  
speed—bu

?

hardware  
ectly to:  
er

85552  
73



way are easily created.

While the UV photopolymer normally used is both expensive and hard to get, a possible hacker substitute could be the *Merigraph* photopolymer used for rubber stamps, and available by way of *Gratham* or *R.A. Stewart*.

A second generation *visible light* photopolymer is being developed at *Dupont*, and one major system which uses these is *Quadrox*. Advantages of the visible photopolymer include its lower viscosity, the ability to use a cheaper laser, and (with proper safety precautions) being able to see what you are doing. Because of the lower viscosity, you can also *raise* the liquid level, rather than actually moving what you have already produced.

While these liquid-vat methods do work, they are limited in accuracy to several mils, are rather costly, and end up severely restricting your choice of materials. A fresh, different, and totally dry approach to desktop prototyping gets used by *DTM*. Here a granular powder of certain waxes or any of a number of plastics is selec-

tively hardened by an infrared laser in a process known as *sintering*. Sintering simply melts the surface of the granules so they stick together.

In addition to being cleaner and simpler, you have a wide variety of possible material options, including real metals. Many powders can be reground and recycled, and they are

far cheaper than the photopolymers.

Let's see, a few loose ends: Other approaches to Santa Claus machines include photochemical machining of thin layers and various other "gasket" techniques that get bonded together to produce composite objects. One think tank doing active instant prototype development is

## NAMES AND NUMBERS

### Alltronics

2300 Zanker Road #D  
San Jose, CA 95131  
(408) 943-9773  
CIRCLE 301 ON FREE INFORMATION CARD

### Castolite

PO Box 391  
Woodstock, IL 60098  
(815) 338-4670  
CIRCLE 302 ON FREE INFORMATION CARD

C-Cube 399A West Trimble Road  
San Jose, CA 95131 (408) 944-6300  
CIRCLE 303 ON FREE INFORMATION CARD

### Circuit Design

1790 Hembree Road  
Alpharetta, GA 30201  
(404) 475-1818  
CIRCLE 304 ON FREE INFORMATION CARD

### Circuit Cellar Ink

4 Park Street S20  
Vernon, CT 06066  
(203) 875-2751  
CIRCLE 305 ON FREE INFORMATION CARD

### Circuit Works

303 Potrero Street, Ste 53  
Santa Cruz, CA 95060  
(408) 459-8088  
CIRCLE 306 ON FREE INFORMATION CARD

### GEnie

401 N. Washington Street  
Rockville, MD 20850  
(800) 638-9636  
CIRCLE 307 ON FREE INFORMATION CARD

### Hitachi

2000 Sierra Point Parkway  
Brisbane, CA 94005  
(415) 589-8300  
CIRCLE 308 ON FREE INFORMATION CARD

### Marlin P Jones

Box 12685  
Lake Park, FL 33403  
(407) 848-8236  
CIRCLE 309 ON FREE INFORMATION CARD

### Micro Linear

2092 Concourse Drive  
San Jose, CA 95131  
(408) 433-5200  
CIRCLE 310 ON FREE INFORMATION CARD

### New Age Industries

2300 Maryland Road  
Willow Grove, PA 19090  
(215) 657-3151  
CIRCLE 311 ON FREE INFORMATION CARD

### Nickel

15 Toronto Street, Ste 402  
Toronto, Ont, CAN M5C 2E3  
(416) 362-8850  
CIRCLE 312 ON FREE INFORMATION CARD

### PM Research

4110 Niles Hill Road  
Wellsville, NY 14895  
(716) 593-3169  
CIRCLE 313 ON FREE INFORMATION CARD

### Schaevitz

7905 North Route 130  
Pennsauken, NJ 08110  
(609) 662-8000  
CIRCLE 314 ON FREE INFORMATION CARD

### SGS

1000 East Bell Road  
Phoenix, AZ 85022  
(602) 867-6259  
CIRCLE 315 ON FREE INFORMATION CARD

### Synergetics

Box 809  
Thatcher, AZ 85552  
(602) 428-4073  
CIRCLE 316 ON FREE INFORMATION CARD

### Texas Instruments

PO Box 809066  
Dallas, TX 75380  
(800) 232-3200  
CIRCLE 317 ON FREE INFORMATION CARD

### 3M/Microproducts

3M Center  
St. Paul, MN 55144  
(800) 328-1303  
CIRCLE 318 ON FREE INFORMATION CARD

## NEW FROM DON LANCASTER

### HANDS-ON BOOKS

Hardware Hacker Reprints II	24.50
Ask The Guru Reprints I or II	24.50
CMOS Cookbook	18.50
TTL Cookbook	16.50
Active Filter Cookbook	15.50
Micro Cookbook vol I or II	16.50
Lancaster Classics Library	99.50
Enhancing your Apple I or II	17.50
AppleWriter Cookbook	19.50
Apple Assembly Cookbook	21.50
Incredible Secret Money Machine	10.50
LaserWriter Reference (Apple)	19.50
PostScript Cookbook (Adobe)	16.50
PostScript Ref. Man. (Adobe)	22.50
PostScript Prog. Design (Adobe)	22.50
Type I Font Format (Adobe)	15.50
Real World Postscript (Roth)	22.50

### UNLOCKED SOFTWARE

LaserWriter Secrets (Ile/Mac/PC)	29.50
PostScript Show & Tell	39.50
Intro to PostScript VHS Video	39.50
PostScript Beginner Stuff	39.50
PostScript BBS Stuff	19.50
The Whole Works (all PostScript)	249.50
Absolute Reset Ile & Iic	19.50
Enhance I or II Companion Disk	19.50
AppleWriter CB or Assy CB Disk	24.50

FREE VOICE HELPLINE

VISA/MC

## SYNERGETICS

Box 809-RE  
Thatcher, AZ 85552  
(602) 428-4073



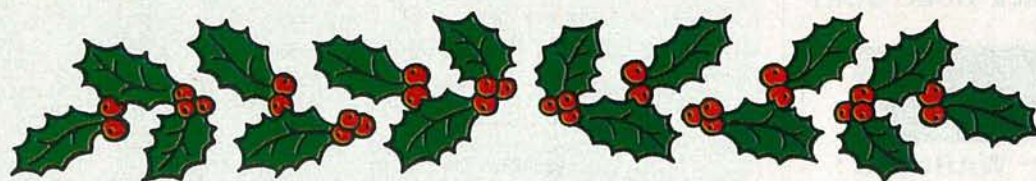

## Plug a Friend into Radio-Electronics this Christmas ... and Save \$19.43!

**This Christmas give an electrifying gift ... plug a friend into Radio-Electronics and brighten his whole new year! Whether electronics is his livelihood or his hobby, your gift will sharpen his focus and illuminate the whole spectrum of electronics throughout the coming year.**

Radio-Electronics will keep him informed and up-to-date with new ideas and innovations in all areas of electronic technology ... computers, video, radio, stereo, solid state technology, satellite TV, industrial and medical electronics, communications, robotics, and much, much more.

He'll get great plans and printed circuit patterns for great electronic projects. In just the last year, Radio-Electronics has presented voice scramblers, video switchers, frequency standards, wireless audio links, radiation monitors, function generators, and much more.

In coming issues, Radio-Electronics will present practical, educational, and money-saving projects like: a helium-neon laser ... a lighting controller ... a video timebase corrector ... a video noise processor ... a light-beam communicator ... an antenna amplifier ... and many others!

PLUS ... equipment troubleshooting techniques ... circuit design ... reports on new technology and new products ... equipment test reports ... in-depth coverage on computers, video, audio, shortwave radio ... and lots more exciting features and articles.

**SAVE \$19.43\*...OR EVEN \$38.86\*...For each gift of Radio-Electronics you give this Christmas, you save a full \$19.43\* off the newsstand price. And as an R-E gift donor, you're entitled to start or extend your own subscription at the same Special Holiday Gift Rate—you save an additional \$19.43\*!**

No need to send money ... if you prefer, we'll hold the bill till January, 1991. But you must rush the attached Gift Certificate to us to allow time to process your order and send a handsome gift announcement card, signed with your name, in time for Christmas.

So do it now ... take just a moment to fill in the names of a friend or two and mail the Gift Certificate to us in its attached, postage-paid reply envelope. That's all it takes to plug your friends into a whole year of exciting projects and new ideas in Radio-Electronics!

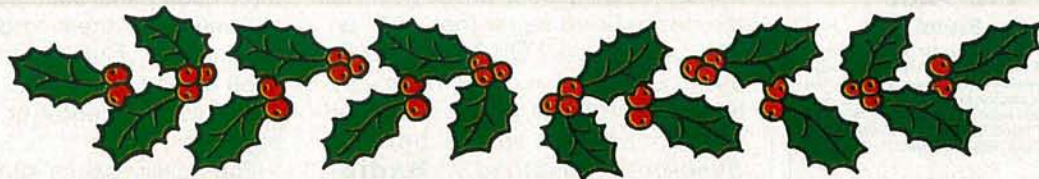



**DIGITAL VIDEO STABILIZER  
ELIMINATES ALL VIDEO COPY  
PROTECTIONS**



While watching rental movies, you will notice annoying periodic color darkening, color shift, unwanted lines, flashing or jagged edges. This is caused by the copy protection jamming signals embedded in the video tape, such as Macrovision copy protection. Digital Video Stabilizer: RXII completely eliminates all copy protections and jamming signals and brings you crystal clear pictures.

**WARNING :**  
**SCO Electronics and RXII dealers do not encourage people to use the Digital Video Stabilizer to duplicate rental movies or copyrighted video tapes. RXII is intended to stabilize and restore crystal clear picture quality for private home use only.**

- FEATURES:**
- Easy to use and a snap to install
  - State-of-the-art integrated circuit technology
  - 100% automatic - no need for any troublesome adjustments
  - Compatible to all types of VCRs and TVs
  - The best and most exciting Video Stabilizer in the market
  - Light weight (8 ounces) and Compact (1x3.5x5")
  - Beautiful deluxe gift box
  - Uses a standard 9 Volt battery which will last 1-2 years.

(Dealers Welcome)

To Order: \$49.95 ea + \$4 for FAST UPS SHIPPING  
**1-800-445-9285** or **516-694-1240**  
 Visa, M/C, COD M-F: 9-6 (battery not included)  
 SCO ELECTRONICS INC.  
 Dept. CRE12 581 W. Merrick Rd. Valley Stream NY 11580  
 Unconditional 30 days Money Back Guarantee

CIRCLE 190 ON FREE INFORMATION CARD

**CABLE TV  
DESCRAMBLER**  
How You Can Save Money  
on Cable Rental Fees



- 1 Unit 10 Lot
- Jerrold SB w/Trimode...\$99.....\$70
  - Super Tri-Mode.....\$109.....\$75
  - Oak KN12 (w/V5).....\$109.....\$65
  - Scientific Atlanta.....\$109.....\$75
  - SA (Combo).....\$250.....\$195
  - Pioneer.....\$109.....\$79
  - Hamlin MLD 1200.....\$89.....\$59
  - Tocom.....\$169.....\$129
  - Stargate converter.....\$95.....\$75
  - Panasonic converter.....\$99.....\$79

**US Cable will  
Beat Anyone's  
Price  
Advertised in  
this Magazine!**

**30 Days Money Back Guarantee**  
Free 16 page Catalog

Visa, M/C, COD or send money order to:  
**US Cable TV Inc. Dept.KRE12**

4100 N.Powerline Rd., Suite F-4  
 Pompano Beach, FL 33073

**1-800-445-9285**

**For Our Record**

I, the undersigned, do hereby declare under penalty of perjury that all products purchased, now and in the future, will only be used on Cable TV systems with proper authorization from local officials or cable company officials in accordance with all applicable federal and state laws. FEDERAL AND VARIOUS STATE LAWS PROVIDE FOR SUBSTANTIAL CRIMINAL AND CIVIL PENALTIES FOR UNAUTHORIZED USE.

Date: \_\_\_\_\_  
 Signed: \_\_\_\_\_

**No Florida Sales!**

CIRCLE 191 ON FREE INFORMATION CARD

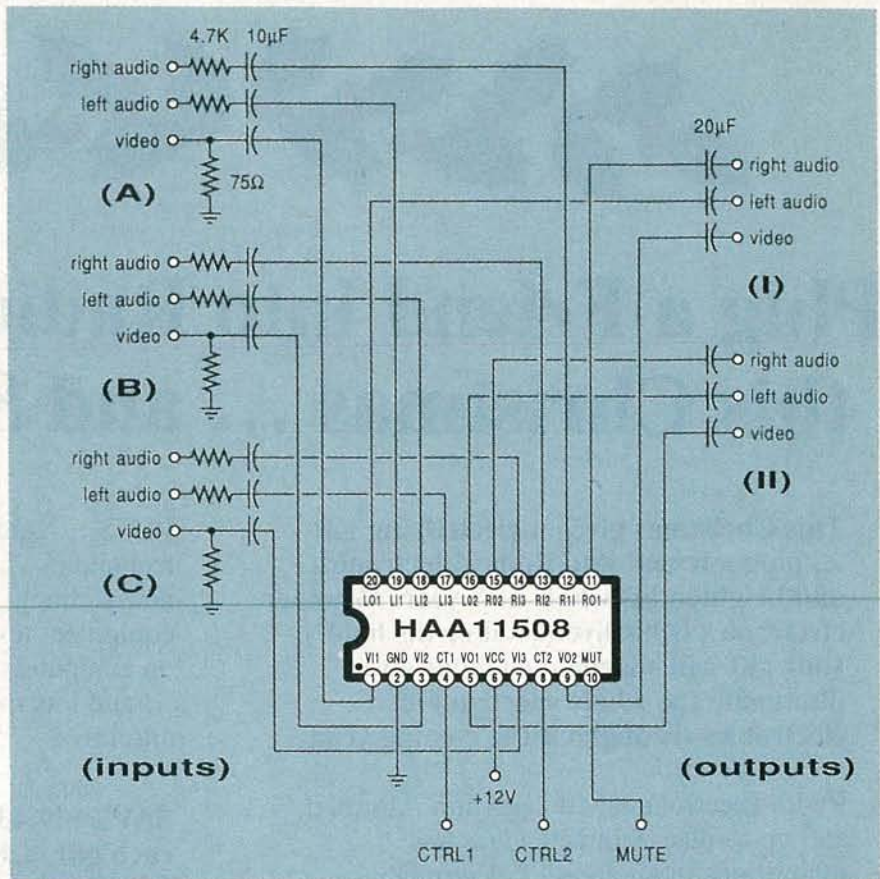

**FIG. 1—THIS TRIPLE AUDIOVISUAL SWITCHER uses the Hitachi HAA11508 to simultaneously select video and two-channel stereo audio from any one of three sources and then route them to one of two selected outputs.**

*Batelle*, while conventions and seminars are sometimes done by the *CAD/CIM Roundtable*. One of the many sources for traditional CAD/CAM support software appears to be *Control Automation*.

One thing that's totally obvious to me is that the PostScript language will play a major role in the future of desktop prototyping. Obvious reasons here are PostScript's nearly total device independence, its incredible graphical performance (especially for three dimensions), and its ability to let your favorite el-cheapo word processor completely and totally blow away virtually any of today's costly CAD/CAM packages.

For our contest this month, just add to our Santa Claus machine dialog in some useful way. There will be all of the usual *Incredible Secret Money Machine* book prizes going to the dozen or so top entries, with an all-expense-paid (FOB Thatcher, AZ) *tinaja quest* for two going to the very best of all. As usual, please send your written entries to me here at *Synergetics*, instead of **Radio-Electronics**.

**An incredible data book**

Certainly one of the most beautiful, largest, and most impressive data books I've ever run across is the incredible new *ASSP for Audio and Video Applications* data book offered by *Hitachi*. It is crammed to the rafters with unique new hacker integrated circuits.

Picking a sample more or less at random, Fig. 1 shows an audiovisual switch using their new HA11508 chip. This beast is hard to describe. It *simultaneously* switches one video and two stereo audio channels from your choice of three sources. As Fig. 2 shows, there are two separate triple outputs, selected per the CTRL1 and CTRL2 lines. The audio on the second triple output can get muted using the *mute* input.

This dude is intended to select three audiovisual sources inside a TV set and route them to two possible destinations. But it cries out to be used as part of a home- or low-end-studio control center or a switching bay.

The quality specs seem fairly impressive. While a 12-volt supply is



CTRL1	CTRL2	OUT I	OUT II
0	0	A	A
0	1	A	C
1	1	B	B
1	0	B	C

FIG. 2—THE TRUTH TABLE for the triple audio switcher. Logic signals on the control inputs decide which input gets selected. An optional mute input turns off the audio only on output II.

recommended, anything from 8 to 13 volts can be used. All the inputs and outputs are supposed to be capacitor-coupled. Since the switching times and all the overlaps are not specified, this chip appears to be mainly intended for use in static switching or source selection. Instead of being applied to chroma-key or picture-insertion applications. Naturally, for any higher-quality switching, full double-sided PC boards with lots of ground plane are an absolute must.

### More on data compression

There sure was plenty of ongoing hacker interest in all of that data-compression stuff we looked at a few months back and in the *Hardware Hacker II* reprints. Much of the action today centers on the new *Discrete Cosine Transform*, especially in high-resolution color computer and TV displays.

Figure 3 is a bibliography of some of the heavier duty papers on the DCT. Start out with Chris Ciarcia's

introductory tutorial in *Circuit Cellar Ink*, and then go on to the fancier stuff shown through *Interlibrary Loan* at your local library.

To compress any video image, individual 8x8 pixel blocks have their discrete cosine transform taken, by using either hardware or software. The result of this transform is a list of frequencies and amplitudes. Any change so minor that the eye can't see it anyway gets replaced with a zero, leaving a sparse data set. Put another way, what you don't know (or see) won't hurt you.

The sparse data set then gets further compacted using *Huffman* or similar techniques. The net result is a video compression in the 30:1 range without causing significant visual degradation.

The reasons for compression is to reduce your disk storage time and your communication time. Far more important, this sort of data compression is essential to squash an HDTV image down into reasonable bandwidth channels. So knowing and understanding video compression is an essential part of the new multimedia revolution which is combining video and computing.

Two sources of DCT chips include *C-Cube* and *SGS*, while some useful (but very much slower) do-it-yourself software routines are shown in the Ciarcia article.

### Digital sine-wave generator

Hardware hackers interested in communications are really getting off on a great new integrated circuit from

## Official 1934 SHORT WAVE RADIO MANUAL



### Build

simple, high-performance old-time shortwave radios!

All of the secrets are here: the circuit diagrams, parts layout, coil specifications, construction details, operation hints, and much more!

This is a compilation of shortwave construction articles from *Short Wave Craft* magazines published in the 20's & 30's. It's wall-to-wall "how-to."

Included are circuit diagrams, photographs, and design secrets of all shortwave receivers being manufactured in 1934 including some of the most famous: SW-3, the SW-5 "Thrill Box", the deForest KR-1, the Hammurand "Comet Pro", and many more.

Also included is a new chapter showing how you can use transistors to replace hard-to-find vacuum tubes. You'll even see the circuit that was lashed together on a table top one night using junk box parts, a hair curler and alligator clips. Attached to an antenna strung across the basement ceiling and a 9 volt battery, signals started popping in like crazy. In a couple of minutes an urgent message from a ship's captain off Seattle over 1500 miles away was heard asking for a navigator to help him through shallow water!



These small regenerative receivers are extremely simple, but do they ever perform! This is a must book for the experimenter, the survivalist who is concerned about basic communication, shortwave listeners, ham radio operators who collect old receivers, and just about anyone interested in old-time radio.

Great book! Fun to read! One of the best old-time radio books to turn up in years. Heavily illustrated! Order a copy today! 8 1/2 x 11 paperback 260 pages only \$15.70 postpaid!

### Lindsay Publications

Box 583-WA8 Manteno IL 60950

Send a copy of *Short Wave Radio Manual*. Enclosed is \$15.70. Chk, MC, Visa. Send a free catalog of other books.

Name \_\_\_\_\_

Address \_\_\_\_\_

City \_\_\_\_\_ St \_\_\_\_\_ Zip \_\_\_\_\_

DECEMBER 1990

#### A Fast Algorithm for the Discrete Cosine Transform

C. H. Smith, *IEEE Transactions on Communications* Sept. 1987 pp 1004-1009.

#### Image Compression for High Speed Network Transmission

C. Ciarcia, *Circuit Cellar Ink*, Aug/Sep 1990, pp 19-26.

#### Teleconferencing

K. Rao, *Van Nostrand Reinhold Company*, 1985.

#### Digital Coding of Waveforms

N. Jayant, *Prentice Hall*, 1984.

#### A New Wave in Applied Mathematics

B. Cipra, *Science* 24 Aug 1990, pp 858-859.

#### Survey of Adaptive Image Coding Techniques

A. Habbibi, *IEEE Transactions on Communications*, Nov 1977, pp 1275-1284.

#### Advances in Picture Coding

H. Mussmann, *Proceedings of the IEEE*, April 1985, pp 523-548.

#### Progressive Transmission of Gray-Scale and Binary Pictures

K. Knowlton, *Proceedings of the IEEE*, July 1980, pp 885-896.

#### Predictive Coding Based on Efficient Motion Estimation

R. Srinivasan, *IEEE Conf. Communications*, May 14 1984, pp 521-526.

#### DCT Processing of NTSC Composite Video Signals

A. Ploysongsang, *IEEE Trans. on Communications*, March 1982, pp 462-479.

FIG. 3—A FEW OF THE RECENT PAPERS on video-image compression and the DCT discrete cosine transform.



**Micro Linear.** This is their ML2035 Programmable Sine-wave Generator. Cleverly disguised as an eight-pin mini-DIP, this new chip is an \$8, full performance, 16-bit digital sine-wave generator. It has a 21-bit phase accumulator and a 9-bit sine lookup table built into it!

The device can easily produce any sine wave from 1 Hz to 25 kHz in 1-Hz steps, and its serial interface mates beautifully with virtually any computer or microcontroller. Figure 4 shows the extremely simple circuit. A split supply of +5 and -5 volts is needed. The output frequency resolution will be:

$$f_{OUT} = f_{XTAL}/8,388,608$$

Thus, you would use the 8.388608-MHz crystal to get a 1-Hz resolution. Or you could apply any external frequency up to 12 MHz.

Your output sine-wave frequency is determined by the 16-bit digital word you last selected. For instance, a digital "1" would get you 1 Hz, while a "5623" (or a hex \$15F7) will get you 5.623 kHz. Your output is a clean and low-distortion sine wave of around 12-volts peak-to-peak.

In order to save on package pins, your digital control word is entered serially. There are three pins involved. The SERIAL INPUT DATA (SID) pin accepts one data bit at a time, the least significant bit first. The SCK or SERIAL CLOCK accepts each new data bit on its rising edge. Finally, the LAT or LATCH pin stores the input serial data stream on its falling edge.

This should interface beautifully with the game-paddle port of an Apple IIe, or anywhere else you have three I/O lines available from a computer or microcontroller. There's also an ML2036 in a larger package with some extra features at slightly higher cost.

One obvious tip: You do enter the frequency in *binary* or in *hex*, and not in decimal! Don't laugh. That's a very common hacker mistake.

As a second contest for this month, just tell me something different you would do with this new ultra-cheap, ultra-simple, and ultra-precise digital sine-wave generator.

#### New tech literature

*Schaevitz* has a free *Handbook of Measurement and Control* that gives the fundamentals of LVDT positioning sensors. From SGS, there's a

### SANTA CLAUS MACHINE RESOURCES

#### Batelle

505 King Avenue  
Columbus, OH 43201  
(614) 424-7782  
CIRCLE 319 ON FREE INFORMATION CARD

#### CAD/COM Roundtable

1050 Commonwealth Avenue  
Boston, MA 02215  
(617) 232-8080  
CIRCLE 320 ON FREE INFORMATION CARD

#### Control Automation

2350 Commerce Park Dr NE, #4  
Palm Bay, FL 32905  
(407) 676-3222  
CIRCLE 321 ON FREE INFORMATION CARD

#### DTM

1611 Headway Circle B2  
Austin, TX 78754  
(512) 339-2922  
CIRCLE 322 ON FREE INFORMATION CARD

#### DuPont

1007 Market Street  
Wilmington, DE 19898  
(302) 774-1000  
CIRCLE 323 ON FREE INFORMATION CARD

#### Freeman Supply

1246 West 70th Street  
Cleveland, OH 44102  
(800) 321-8511  
CIRCLE 324 ON FREE INFORMATION CARD

#### Grantham/Polly-Stamp

418 Central Avenue NE  
East Grand Forks, MI 56721  
(218) 773-0331  
CIRCLE 325 ON FREE INFORMATION CARD

#### Industrial Education

1895 Crooks Road S135  
Troy, MI 48084  
(313) 649-4900  
CIRCLE 326 ON FREE INFORMATION CARD

#### Light Machines

669 East Industrial Drive  
Manchester, NH 03103  
(603) 625-8600  
CIRCLE 327 ON FREE INFORMATION CARD

#### masterCAM

2101 Jericho Turnpike  
New Hyde Park, NY 11040  
(516) 328-3970  
CIRCLE 328 ON FREE INFORMATION CARD

#### Merigraph/Hercules

300 East Shuman, Ste 260  
Naperville, IL 60566  
(800) 323-1832  
CIRCLE 329 ON FREE INFORMATION CARD

#### Quadrax

300 High Point Avenue  
Portsmouth, RI 02871  
(401) 683-6600  
CIRCLE 330 ON FREE INFORMATION CARD

#### Roland Digital

7200 Dominion Circle  
Los Angeles, CA 90040  
(213) 685-5141  
CIRCLE 331 ON FREE INFORMATION CARD

#### School Shop

Box 8623  
Ann Arbor, MI 48107  
(313) 769-1211  
CIRCLE 332 ON FREE INFORMATION CARD

#### RA Stewart

641 South Palm, Unit H  
La Habra, CA 90631  
(213) 690-4445  
CIRCLE 333 ON FREE INFORMATION CARD

#### 3-D Systems

26081 Avenue Hall  
Valencia, CA 91355  
(805) 295-5600  
CIRCLE 334 ON FREE INFORMATION CARD

new data book on *Protection Devices* that includes surge and transient suppressors.

*Texas Instruments* has a new and free linear products sample packet on their *Excalibur* series of JFET operational amplifiers.

Two great surplus flyers include *Alltronics*, who are big on powerful magnets and computerized hamsters (their dead ones are cheaper); and

*Marlin Jones*, who has some new tilt-angle sensors, parabolic mirrors, LCD displays, clutches, and regulators.

Our featured free trade journals for this month include *Circuit Design* on printed-circuit layout techniques, and *Nickel*, devoted to stainless steel and all other nickel applications.

Still at the same old stall after all these years, the *Castolite* people of-



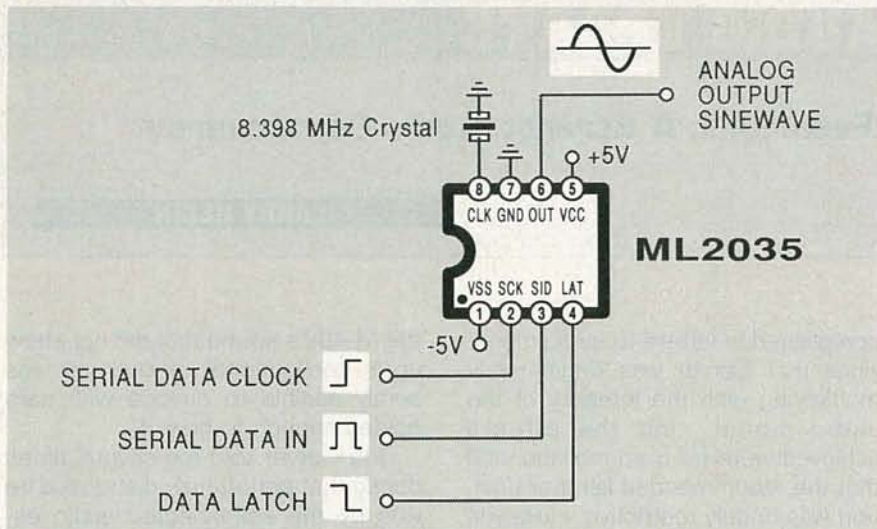

FIG. 4—A DECEPTIVELY SIMPLE DIGITAL SINE-WAVE GENERATOR. This \$8 chip does a full 21-bit phase addition and a 512-level table lookup for an outstanding output quality. Resolution is 1 Hz over a 1-Hz to 25-kHz range!

fer all sorts of castable resins and mold products. One good way to get started with the castable resins is to pick up their \$75 product sample and evaluation kit.

The *Circuit Works* people have an interesting conductive pen that writes in silver ink. The main use for this unusual gadget is for printed-circuit-board repairs.

For some additional mechanical stuff, 3M has an interesting brochure on microcapsule technology, while free plastic-tubing samples are newly available through *NewAge Industries*. And *PM Research* has a fine catalog on steam-engine kits.

Turning to my own stuff, I have combined my seven top hacking books into a *Lancaster Library* at a

very special price. These include the *TTL Cookbook*, *CMOS Cookbook*, *Active Filter Cookbook*, *Micro Cookbook I*, *Micro Cookbook II*, *Hardware Hacker II*, and, of course, *The Incredible Secret Money Machine*.

Finally, I do have a new and free mailer for you which includes dozens of insider hardware-hacking secret sources. Write or call for info.

Our usual reminder here that most of the items mentioned appear either in the *Names and Numbers* or in the *Santa Claus Machines* sidebar.

As always, this is your column and you can get technical help and off-the-wall networking per that *Need Help?* box. The best calling times are weekdays 8–5, *Mountain Standard Time*. Let's hear from you. **R-E**

## Data Acquisition and Control the Easy Way

### What is the A-Bus?

A-Bus is a system for connecting devices to your computer. Whatever your computer, use A-Bus for:

**Sensing.** Detecting or reading a switch closure or voltage presence.

**Measuring.** Determining a force, frequency, temperature, weight, or any other quantity.

**Control.** Open or close a circuit. Switch any type of electrical device. Adjust level or position.

### Why should you choose A-Bus?

**It's affordable.** From a \$65 Digital Input Card to a \$299 Motor Controller, you get much more than your money's worth.

**It's simple.** Easy to connect to your computer and to your application. Designed to adapt to your software easily.

**It's versatile.** You mix and match low cost boards to fit your project.

**It's proven.** Thousands of applications installed around the world.

Call for a Catalog (800) 221-0916

### A Sampling of our Products

**Relay Card:** 8 individually controlled relays. 3A at 120VAC, SPST. **RE-140: \$142**

**High-Speed 12-bit A/D converter:** 8 10µs analog inputs. 0–5V, amp. **FA-154: \$179**

**8 Bit A/D:** 8 inputs, 0–5.1V in 20mV steps, 7500 conversions/second. **AD-142: \$142**

**12 Bit A/D:** ±4V, On-board amp, 7 readings/sec, 1 input, expandable **AN-146: \$153**

**Temperature Sensor:** 0–200° **TS-111: \$12**

**Digital Input:** 8 opto-isolated. Read voltage presence or switch closures. **IN-141: \$65**

**Latched Input:** Each of 8 inputs is latched to catch switch closures **LI-157: \$85**

**Digital Output Driver:** 8 outputs: 250mA at 12V. For relays, solenoids... **ST-143: \$78**

**Smart Quad Stepper Controller:** On board processor controls 4 motors simultaneously.

Simple English commands to set position, speed, units, read limits, etc. **SC-149: \$299**

**D/A:** 4 Channel, 8 Bit Output **DA-147: \$149**

**24 line TTL I/O:** Connect TTL 0/5V levels or switches. (8255A) **DG-148: \$72**

**32 Channel Multiplexer:** Switches up to 32 channels to a single common. **MX-155: \$83**

**Touch Tone Decoder:** **PH-145: \$87**

**Counter Timer:** 3 16-bit counters. Count pulses, measure frequency **CT-150: \$132**

**A-Bus Prototyping card:** **PR-152: \$16**

**Odin Software:** For PC's Control relays from inputs or time schedules **OS-189: \$129**

**Motherboard:** For 5 cards. **MB-120: \$108**

#### A-Bus Adapters:

**IBM XT/AT & compatibles.** **AR-133: \$69**

**MicroChannel Adapter:** **AR-170: \$93**

**Parallel Adapters** also available for Apple II, Commodore 64,128, TRS-80

**Serial Adapter:RS-232** **SA-129: \$149**

**Serial Processor:** Built in BASIC for off-line monitoring, logging. **SP-127: \$189**

**New! C-Net:** Connect thousands of RS-232C serial devices to one computer port. Printers, modems, data acquisition devices, etc.

**ALPHA Products**

242-RE West Avenue, Darien, CT 06820

Call (203) 656-1806 or Fax 203 656 0756

Try the  
**Radio Electronics®**

bulletin board system

(RE-BBS)  
516-293-2283

The more you use it the more useful it becomes.

We support 300 and 1200 baud operation.

Parameters: 8N1 (8 data bits, no parity, 1 stop bit) or 7E1 (7 data bits, even parity, 1 stop bit).

Add yourself to our user files to increase your access.

Communicate with other R-E readers.

Leave your comments on R-E with the SYSOP.

RE-BBS  
516-293-2283



## Amplifier Transfer Functions: A Strange Audio Controversy

LARRY KLEIN

**M**y IEEE dictionary defines transfer function as "a mathematical, graphic, or tabular statement of the influence that a system or element has on a signal or action compared at input and output terminals..." The somewhat stilted language refers essentially to whatever differences occur between the input and output signals of a circuit. It may seem strange that an innocuous technical term like "transfer function" could in another guise excite such passions in the audiophile community. It all began, as have several other audio controversies in the past decade, with the work of Bob Carver, former president of Phase Linear, and presently the president and chief engineer of the Carver Corporation.

### The Carver Corporation

When Carver founded the company that bears his name, he produced two products that both excited audio consumers and rattled a few cages. The first to hit the market was a "sonic holography" preamplifier that provided an enormous extension of the sonic sound stage far beyond normal speaker spacing. In fact, on certain program material, the effect is as though two invisible side-wall speakers have been switched in. The holographic illusion is achieved by electronically nullifying the interaural crosstalk that occurs with conventional speaker setups. Normally, the sound from the right speaker reaches your left ear and the sound from the left reaches your right ear; the Carver circuit injects some out-of-phase left signal into the right channel and vice versa, thus electronically canceling, when you are properly located, the acoustic "leakage" between both channels.

Carver's sonic holograph prompted a host of "me-too" products, and variations on the idea are still found in the products of some companies. Not surprisingly, purist audiophiles

complained in letters to audio magazines that Carver was illegitimately monkeying with the integrity of the audio signal, that the effects achieved were far from realistic, and that the recommended listener position was unduly restrictive. However, buyers of the Carver sonic-holograph preamp simply enjoyed its effect, untroubled by the objections of the purists.

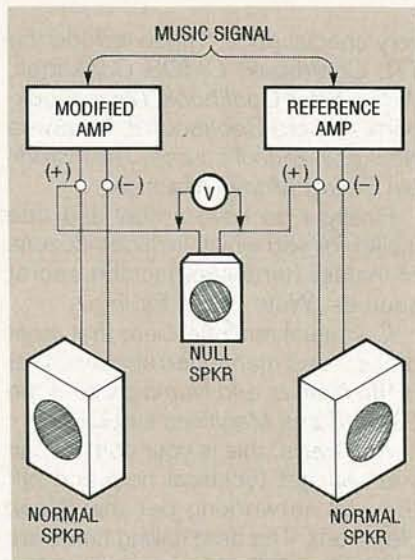

**Fig. 1. CONNECTION FOR COMPARING one channel of a reference amplifier to one channel of the modified amp. The normal speakers, whose purpose is to provide a typical load, are placed out of earshot. The null speaker plays only the difference between the two channels. Theoretically, two identical channels will produce no sound from the null speaker. A meter connected across the null speaker has revealed nulls as low as -70 dB.**

### The Carver challenge

Bob Carver's next project was the M-400 "magnetic-field" amplifier. Truly a revolutionary product, it was a 200-watt-per-channel amplifier embodied in a 7-inch cube weighing a mere 10 pounds. Once again, audiophiles who tended to judge an amplifier's quality by its cost—and the severity of the hernia you got trying to lift it—were outraged. Obviously, there had to be something wrong with

the M-400's sound that did not show up in conventional testing, yet was surely audible to anyone with ears golden enough to hear it.

Bob Carver told me several times during that period how distressed he was by the self-selected audio esthetes who felt that he was, at best, a designer of mid-fi equipment. Carver set out to prove them wrong. He devised and demonstrated a nullification circuit (not unlike the Hafler circuit discussed in these pages several years ago) that would null out all similarities in the signal between any two amplifier channels leaving only whatever differences might exist in phase shift, frequency response, distortion, and/or noise to be heard.

I attended at least two of Carver's demonstrations and came away convinced that his amplifier was essentially perfect in respect to absence of any audible problems. In truth, I was not terribly surprised by Carver's test results since I believe that almost any well-designed amplifier when operated with a reasonable speaker load and within its power rating will sound like any other amplifier also operated under the same conditions. (That is also Carver's view, but he hesitates to propagate it for fear of further alienating the irrational self-appointed audio elite.) In any case, Carver made his point among those willing to be convinced. But Carver's test convinced none of the audio fundamentalists whose ultimate faith resides in what they think they hear under their own essentially uncontrolled listening conditions.

For this group, only prolonged listening to one amplifier and then the other will allow proper evaluations to be made. Anyone who has attempted to make scientific subjective assessments in any product area knows of the pitfalls of such a procedure, but nevertheless, that is the preferred audiophile evaluation technique.

Okay, thought Carver, let's approach the problem from a different



direction. He issued a challenge to the editors of *Stereophile* magazine: You pick out an esteemed high-end power amplifier—tube or transistor—and I will duplicate its sound by minor modifications of one of my current \$700 magnetic-field amplifiers. Carver flew out to *Stereophile*'s Santa Fe, NM, offices and set up his equipment in a nearby motel, and *Stereophile* brought over a massive \$5,000 tube amplifier to serve as the reference. Several days later, Bob emerged from his instrument- and parts-cluttered motel room with the modified Carver amplifier whose sound he claimed exactly matched that of *Stereophile*'s audiophile tube amplifier.

Here comes the surprising part: After hours of comparison listening, the flabbergasted editors of *Stereophile* reluctantly agreed that Carver had accomplished just what he claimed he would. The sound of the two amplifiers was *indistinguishable* even with the "best available" associated equipment and speakers! The implications of what Carver had done was not lost on those who had participated in the event. How could Carver's amplifier duplicate the sound of the reference, without the use of gold-plated connectors and circuit boards, oxygen-free copper wire, capacitors with special dielectrics, and metal-film resistors, and all the other magical elements—including tubes—that are found in audiophile amplifiers? Could it be, as Carver claimed, that the only thing necessary was to get the proper transfer function?

Now for the unsurprising part. Upon reflection, reconsideration, and relistening to the original modified Carver amp plus other samples that Carver had modified similarly, *Stereophile*'s staff decided that the amplifiers really didn't sound alike after all. How could they, when the basic premise of the magazine (and high-end audio) suggests the existence of subtle, mysterious audible differences that differentiate audiophile equipment from that produced by the "mass merchandisers" such as Carver. You wipe out those differences and you obviously wipe out the justification for overpriced and over-designed high-end audio equipment.

I asked Bob exactly what he does to match the sound of two amplifiers. Essentially, he said, the differences

he's eliminating are all in the spectral domain. However, that involves more than simply matching the frequency-response characteristics of two amplifiers. Every amplifier has a characteristic complex input and output impedance that causes small frequency response variations when driving various speakers and when being driven by various input components. Matching the sound of two amplifiers consists essentially of matching those impedance characteristics. It isn't necessary to work out the reasons for the impedance characteristics of the reference amp, only to duplicate them.

## Postscript

I thought that Carver's approach to amplifier matching would make an interesting story and I offered it to *Audio* magazine. The editor, whom I've known for years, turned me down flat. Why? His belief system, like those of the editors of *Stereophile*, would not permit him to accept that Carver's feat was possible. And a final note: Since *Stereophile* recanted, they have, in Carver's view, constantly attacked his products in editorial comments and reviews. That has led indirectly to a series of legal claims and counterclaims, which, are now being worked out in court. **R-E**

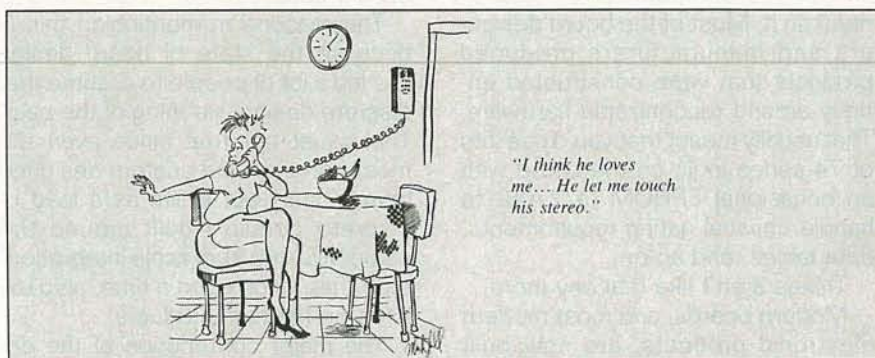

## Cable TV Descrambler Article Parts

We stock the exact Parts, PC Board and Adaptor for several articles published in *Radio-Electronics* magazine on building your own Cable TV Descrambler.

### February 1984 SB-3 Type

701 Parts Pkg.....\$19.00  
Includes all original parts.

702 PC Board.....7.95  
Original 3X4 etched, drilled  
and Silk-Screen pc board.

704 AC Adaptor.....7.95  
12 to 18 Volt DC @ 200ma.

701, 702 & 704.....29.00  
All three for special saving.

### February 1987 Tri-Mode

301 Parts Pkg.....29.00  
Includes all original parts.

302 PC Board.....7.95  
Original 5X8 etched, drilled  
and Silk-Screen pc board.

304 AC Adaptor.....7.95  
12 to 18 Volt DC @ 200ma.

301, 302 & 304.....39.00  
All three for special savings.

Tri-Mode Tutorial..7.95  
26 pages of in-depth info.

### May 1990 Universal

901 Parts Pkg.....\$49.00  
Includes all parts.

902 PC Board.....9.95  
Improved 4X7 etched, drilled  
and Silk-Screened pc board.

904 AC Adaptor.....8.95  
12 Volts AC @ 350ma.

901, 902 & 904.....59.00  
All three for special savings.

### Snooper Stopper...\$39.00

Prevent Descrambler detection with snooper stopper/data blocker and protect your privacy. Includes free article on Cable Snooping.

### Macrovision Kit...\$29.00

Macrovision.....now you see it, now you don't with our macro-scrubber kit. Originally Published in *Radio-Electronics*.

### 70 Channel Cable TV Converter.....\$89.95

- \* 6 Function Infra-Red remote.
- \* Fine Tuning.
- \* Memory & Recall.
- \* Compatible with all External Descrambler.
- \* Channel 3 & 4 switchable output.
- \* STD, HRC & IRC compatible.

## CALL TOLL FREE 1-800-332-3557

Outside USA Call 1-508-699-6935

Visa, MasterCard and COD.  
Add \$4.00 S&H, \$6.50 Outside USA.

D & D Electronics, Inc. PO Box 3310, N. Attleboro, Ma. 02761

VISA

MC



# DRAWING BOARD

Let's keep our DTMF generator circuit as simple and as elegant as possible.

ROBERT GROSSBLATT

Just about everyone who owns a computer has had to deal with plug-in cards at one time or another. Back in the old days, there were no such things as ASIC's (application specific integrated circuits), and it was even rare to see a board with PAL's (programmable logic arrays) on it. Most of the board designers and manufacturers produced products that were constructed entirely around recognizable hardware. That usually meant that you'd see lots of 74-series logic on the board with an occasional EPROM (a 2708) to handle unusual gating requirements, data tables, and so on.

Things aren't like that any more.

Modern boards, and most modern electronic products, are now built around custom silicon since the failure rate is a lot lower and the cost of production is less as well. This is good for the consumer since the products are a lot more reliable and less expensive. A VGA card is an extremely complex circuit but you'll find the parts count to be minimal.

The down side of all this is that it's next to impossible to fix any of the newer boards. You not only can't get the ASIC's that form the heart of the design but, even if you could, very few (if any) of such newer boards are delivered with a schematic and circuit description.

The reason I'm mentioning this is because the state of board design has led a lot of people to assume that discrete design is a thing of the past. That's just not true since even the most complex and custom designed boards start out in life as a load of discrete circuitry built around the same MSI (medium scale integration) stuff that, once upon a time, also existed on the final products.

The major contribution of the development of ASIC's has to do with economy, not electronics. The same sort of argument applies to component density. Not every product made to work with a computer has to be complex. As a matter of fact, Grossblatt's Fourteenth Law—Keep it Simple—tells you that things

should be only as complicated as they have to be to get the job done. Not only that, but the more time you spend doing electronics, the more you'll appreciate the advantages you get when you keep things as simple as possible. If the word "simple" bothers you, think of it as being "elegant" instead.

The circuitry for the controller we're building doesn't have to be any more complex than is required by the job it's designed to do. We're building a telephone dialer and, although there are certainly an infinite number of things we can have it do, all we're looking for in the beginning is the ability to generate DTMF tones—and we've already talked about all the silicon needed to do that.

The DTMF generator we're designing is basically a two-chip circuit since most of the work is done by the 5088 that generates the tones. Although tone-generator chips are a far cry from an ASIC, it would take an impressive amount of silicon to replace them.

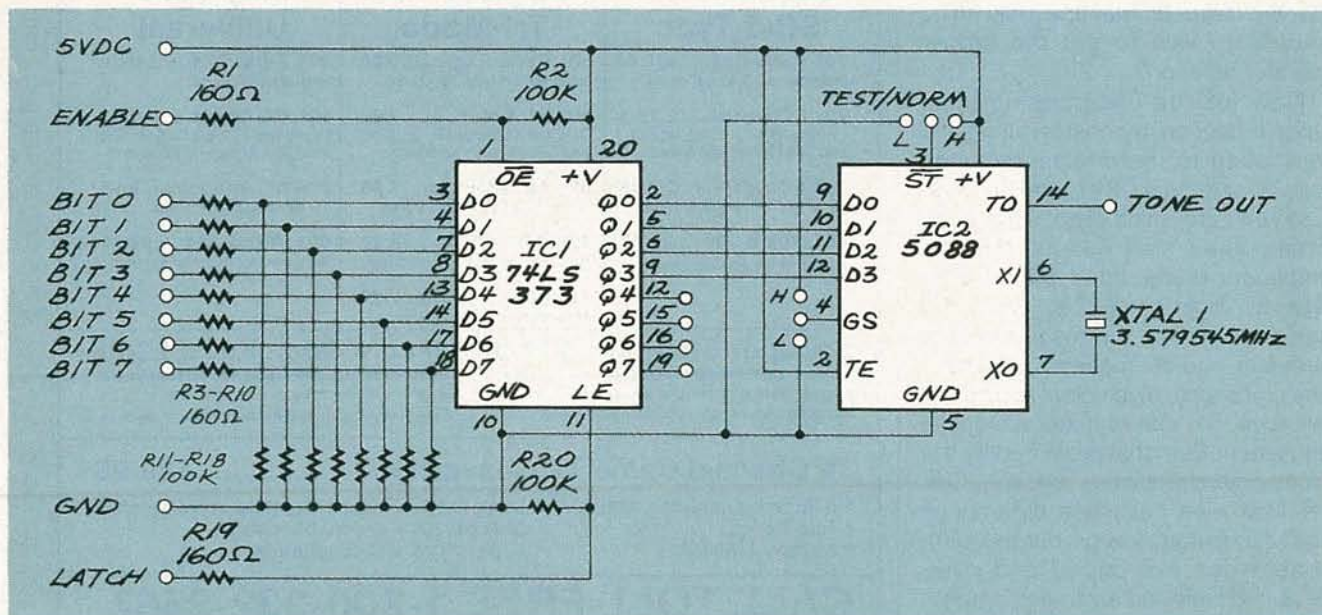

FIG. 1—THIS CIRCUIT COMBINES the latch layout we already developed with the 5088. With a bit of simple software, it will generate DTMF tones under keyboard or program control.



# R-E Engineering Admart

Rates: Ads are 2 1/4" x 2 7/8". One insertion \$950. Six insertions \$925. each. Twelve insertions \$895. each. Closing date same as regular rate card. Send order with remittance to **Engineering Admart**, Radio Electronics Magazine, 500-B Bi-County Blvd., Farmingdale, NY 11735. Direct telephone inquiries to Arline Fishman, area code-516-293-3000. **Only 100% Engineering ads are accepted for this Admart.**

## FCC LICENSE PREPARATION

The FCC has revised and updated the commercial license exam. The **NEW EXAM** covers updated marine and aviation rules and regulations, transistor and digital circuitry.

**THE GENERAL RADIOTELEPHONE OPERATOR LICENSE - STUDY GUIDE** contains vital information. **VIDEO SEMINAR KITS ARE NOW AVAILABLE.**

WPT PUBLICATIONS  
979 Young Street, Suite E  
Woodburn, Oregon 97071  
Phone (503) 981-5159 Dept. 50

CIRCLE 182 ON FREE INFORMATION CARD

## Surface Mount Chip Component Prototyping Kits—

Only \$49.95



CC-1 Capacitor Kit contains 365 pieces, 5 ea. of every 10% value from 1pf to .33µf. CR-1 Resistor Kit contains 1540 pieces; 10 ea. of every 5% value from 10Ω to 10 megΩ. Sizes are 0805 and 1206. Each kit is ONLY \$49.95 and available for Immediate One Day Delivery!

Order by toll-free phone, FAX, or mail. We accept VISA, MC, AMEX, COD, or Pre-paid orders. Company P.O.'s accepted with approved credit. Call for free detailed brochure.

**COMMUNICATIONS SPECIALISTS, INC.**  
426 West Taft Ave. • Orange, CA 92665-4296  
Local (714) 998-3021 • FAX (714) 974-3420

Entire USA 1-800-854-0547

CIRCLE 176 ON FREE INFORMATION CARD

## INCREASE YOUR EARNING POWER!

LEARN TO DESIGN WITH SINGLE CHIP MICROCOMPUTERS!

SINGLE CHIP MICROCOMPUTER PRIMER FOR MOTOROLA 6805

Includes:  
• Professional Quality MS-DOS Software  
• Editor  
• Assembler  
• Simulator/Debugger  
• Programmer Schematics  
• Single Chip Microcomputer Primer Lesson Book

Price ..... \$195

MCPM-1 Programmer for Motorola MC68705P3,P5,U3,U5,R3,R5  
Parts kit w/driver program ..... \$150  
Fully assembled w/driver program ..... \$325  
Fully assembled w/driver assembler/simulator/debugger ..... \$449

MCPM-3 Programmer for Motorola MC68HC705C8, 805C4  
Parts kit w/driver program ..... \$175  
Fully assembled w/driver program ..... \$360  
Fully assembled w/driver assembler/simulator/debugger ..... \$495

**TECI**  
The Engineers Collaborative Inc.

Emulators Programmers Assemblers Simulators/Debuggers  
Rt. #3, Box 8C TEL: (802) 525-3458  
Barton, VT, USA 05822 FAX: (802) 525-3451

CIRCLE 192 ON FREE INFORMATION CARD

We've already laid out most of the circuit we need to implement our design, and all we have left to do (from the point of view of hardware) is to put it all together. The circuit shown in Fig. 1 combines the latch layout we already developed with the 5088 and, when we add a bit of simple software, will generate DTMF tones under keyboard or program control.

The first four data lines from the parallel port are used to talk to the 5088 through the latch. Even though the latch control of the 373 is brought out to the connector going to the parallel port, we can ignore it for a while by tying the enable line to ground. You can do this with a jumper on the breadboard or, if you want, seven of the pins on the parallel-port connector can be tied to ground. There were originally eight ground pins but remember that we modified one of them (I suggested pin 25) so that it would carry five volts and make it easier to power the circuit we're building.

The only thing new in the schematic is the colorburst crystal added across pins 6 and 7 of the 5088. That is the only component we have to add to the circuit to make it work. The jumper shown hanging off pin 3 allows you to tie the pin either high or low. Making it high will enable the chip to generate DTMF, and making it low will cause the IC to generate the high- and low-group tones separately. The selection of high or low group is made

with the jumper at pin 4. If you tie pin 4 low, the chip will generate the low-group tones, and tying it high will generate the high-group tones. If you make pin 3 high by connecting it to +V, the chip generates DTMF regardless of the connection made at pin 4.

Although the circuit shown in Fig. 1 still has to have things added to it if you want to do practical things with it (connect it to the phone line, control a telephone, etc.), that doesn't mean it has no use at all. Since it's generating real DTMF, the output of the 5088 can be connected to any circuit that gets driven or controlled by DTMF tones. We'll talk about additional hardware later on but, for the moment, it's time to turn to the software part of the design.

Since this is the most basic hardware design we'll have for the circuit

TABLE 1

5088 DTMF GENERATOR INPUTS AND OUTPUTS							
KEY PAD	D	D	D	D	HEX IN	OUT LOW	OUT HIGH
	3	2	1	0			
1	0	0	0	1	1	697	1209
2	0	0	1	0	2	697	1336
3	0	0	1	1	3	697	1477
4	0	1	0	0	4	770	1209
5	0	1	0	1	5	770	1336
6	0	1	1	0	6	770	1477
7	0	1	1	1	7	852	1209
8	1	0	0	0	8	852	1336
9	1	0	0	1	9	852	1477
0	1	0	1	0	A	941	1336
*	1	0	1	1	B	941	1209
#	1	1	0	0	C	941	1477
A	1	1	0	1	D	697	1633
B	1	1	1	0	E	770	1633
C	1	1	1	1	F	852	1633
D	1	1	0	0	0	941	1633

(other refinements will come later), it stands to reason that the software is going to be simple as well...at least at this stage of the game.

All we're interested in at the moment is writing a few lines of code to tell us whether the hardware is working or not. Since I want to keep things as broadbased as possible, I'll write the software in Basic.

Although you're free to drive the latch with any four of the many outgoing lines on the addresses that make up the parallel port, we can be nice and logical and use the data port. If the port you're working with is LPT1, the data port is at 3BCh or 956 decimal. Things aren't as clear with the other parallel ports, (LPT2, LPT3, etc.), since the addresses aren't fixed. LPT2, for example, can have its base address at 378h, 278h, or elsewhere.

As I talk about software, I'll be referring to LPT1. If you're using a different port, you'll have to substitute the proper addresses yourself. The hardware is set to pay attention to only the lower four bits of the data port and, as you can see from Table 1, the bit combination sent to the port will determine which one of the DTMF tones we generate.

The actual code we need to exercise the hardware is simple stuff since it's nothing more than a single OUT instruction. All we want to do is send the data shown in Table 1 on the

(Continued on page 90)



# NEXT MONTH IN Popular Electronics

## Exciting Features, Projects, Reports, & Columns

- **BUILD A BINARY CLOCK**  
A great conversation piece for your home or office
- **ROLL YOUR OWN RADIO**  
Build a crystal radio using only home-made parts
- **SUPER-SIMPLE FREQUENCY COUNTER**  
Build it as a stand-alone unit or as an add-on for other projects
- **BUILD A SHORTWAVE PRESELECTION**  
Improve the performance of your receiver with these easy projects

# Popular Electronics

JANUARY 1991



ON SALE NOV. 15, 1990



## And there is more!

**PRODUCT REVIEWS**—Casio color-LCD pocket TV, Nikon Hi-8 camcorder, Videonics color equalizer, Sams Photofacts, and more.

**DX LISTENING**—Business news on shortwave radio.

**COMPUTER BITS**—Do computers interfere with creativity?

**CIRCUIT CIRCUS**—Build a "time-out" circuit, a two-input door-bell annunciator, and a simple speakerphone.

**HAM RADIO**—Adjusting antennas with an RF dip meter.

**ANTIQUE RADIO**—Building your own radio-tube tester.

## IC SPOTLIGHT

continued from page 66

### Chips of a feather...

...come in sets together. Thanks to LSI Logic, you can now build an entire core of a workstation which is binary compatible with the SPARCstation-1, a reduced instruction-set computer (RISC)-based workstation made by Sun Microsystems, from a single 7-chip set. All that's needed to complete the system are peripherals and their controllers, boot PROM's, and the main and cache memories. Figure 1 shows a block diagram of the 7-chip system.

The chip set includes an integer processor, a floating-point processor, memory-management, direct memory access (DMA), standard I/O and bus controllers, and cache controllers and tags. At the heart of the system are two processors, the L64811 and L64815. The L64811 RISC-based integer unit (IU) has 136 general-purpose registers organized into eight-register windows. It has a four-stage pipeline, and can execute most commands in a single cycle, thus giving it 18–29 MIPS of performance. It also has two coprocessor interfaces, one for a user-definable coprocessor, and the other for the L64814 FPU. The L64814 performs double-precision operations at speeds of up to 6 megaFLOPS at 40 MHz. The FPU's controller section synchronizes the FPU with the IU and provides additional floating-point hardware support.

The L64815 is a cache memory-management controller that implements the SPARC Reference memory management unit's (MMU's) virtual address translation mechanism as specified by Sun and AT&T. Using a 64-entry translation look-aside buffer (TLB), this MMU implementation will be used in all future Sun workstations, and will support the next release of SunOS and UNIX System V, Release 4.

The L64815 also provides cache tagging, with the tag memory integrated into the IC. There are 2048 usable tags, giving the designer great flexibility in designing the memory subsystem. It can be made up of 32-, 64-, 128-, or 256-kilobytes of combined data and instruction cache memory, with line sizes of either 32, 64 or 128 bytes.

PICK UP Popular Electronics AT YOUR FAVORITE NEWSSTAND, CONVENIENCE STORE, OR SUPERMARKET.



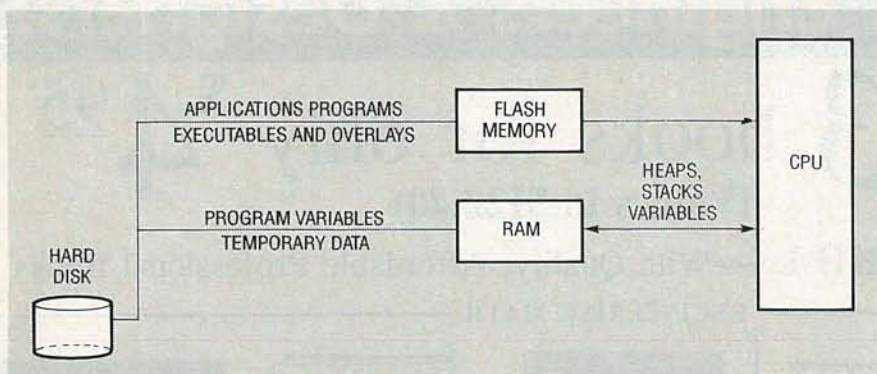

FIG. 2—FLASH MEMORY CAN BE used to store entire programs from disk. RAM is still needed, though, to store program heaps, stacks, variables, and other data that must change randomly throughout the program's run time.

The memory manager connects to the memory through a high-speed "M bus," which passes data to and from memory at a blazing 320-megabytes per second at 40 MHz. Peripheral controllers connect to both each other, as well as to the processors and memory through the Sun-developed "S bus," which pushes data through at 100-megabytes per second at 25 MHz.

The L64852 Mbus-to-Sbus controller is used to control the two buses. That IC has five primary functions: 1. to act as an Mbus arbiter, 2. to act as an Sbus controller, 3. it is an Mbus and an Sbus master/slave controller and data buffer, 4. it provides Mbus-to-Sbus protocol conversion, and 5. it is used for I/O memory management.

The set is rounded off by a main-memory controller, the L64850, a Standard I/O controller, the L64851 and a DMA controller, the L64853, which connects to a small-computer systems interface (SCSI) and local-area network (LAN) controller. Two versions of the system are the SparKIT-25 and the SparKIT-40, which provide 18 and 29 MIPS of performance, respectively. Both chip sets are used in LSI Logic's proprietary 0.7-micron HCMOS process. The SparKIT-25 is \$1,327.00 per kit, in 1000-unit quantities.

### Memory in a flash

As new types of microprocessors hit the scene, so too must new types of microcomputer memory to support them. One such new type of memory is the flash memory from Intel. Touted as non-volatile RAM, these devices are more similar to a higher-speed, lower-cost EEPROM's.

The chips are non-volatile in nature

and data can be read randomly, but that's where the RAM similarity ends. Writing and erasing has to be done to the whole chip at once. Erasing an entire 1-megabit chip takes one second, while writing data to that whole chip takes four seconds.

A possible application of flash memory is shown in Fig. 2. Flash memory can be used to store entire programs from disk, which the CPU runs as if it were from RAM. RAM is still needed to store program heaps, stacks and variables and other data that must change randomly while the program is running.

Since they can't be written to randomly, flash memories will not likely replace all of the RAM in any systems. They can be of great use, however, in reducing PC-board real estate in workstations that need a lot of memory to store running applications. Such applications will, of course, have to be rewritten to map temporary memory contents into RAM and keep executable and overlay files in flash. Of course, their first application will likely be as nonvolatile backup memory that will come into play in the event of a power failure or as storage in laptop computer systems.

The typical cost of Intel's flash memory chips varies according to the memory density. The price for a 1-megabit 28F010 is \$18.70, and is sold in a DIP package. A 2-megabit 28F020 costs \$34.80 in a DIP package, and \$45.20 in a thin small-outline package (TSOP) used in surface-mount technology (SMT) designs. All prices are for 10,000 unit quantities. We'll see you next month for a look at the all but forgotten world of analog multiplier IC's and the role they play in phase-locked loops.

R-E

# ATTENTION! ELECTRONICS TECHNICIANS

EARN YOUR  
**B.S.E.E.  
DEGREE**



## THROUGH HOME STUDY

Our New and Highly Effective Advanced-Placement Program for experienced Electronic Technicians grants credit for previous Schooling and Professional Experience, and can greatly reduce the time required to complete Program and reach graduation. No residence schooling required for qualified Electronic Technicians. Through this Special Program you can pull all of the loose ends of your electronics background together and earn your B.S.E.E. Degree. Upgrade your status and pay to the Engineering Level. Advance Rapidly! Many finish in 12 months or less. Students and graduates in all 50 States and throughout the World. Established Over 40 Years! Write for free Descriptive Literature.

## COOK'S INSTITUTE OF ELECTRONICS ENGINEERING

4251 CYPRESS DRIVE  
JACKSON, MISSISSIPPI 39212

CIRCLE 58 ON FREE INFORMATION CARD

# ISCET VCR Cross Reference

VCR Model Number Cross Reference  
and VCR Parts Cross Reference

**UPDATED** - Feb. 1990. 272-page reference guide. \$35 plus \$3 shipping.

**DISC** - IBM-compatible disc with expandable data base. \$99 plus \$1 shipping.

**COMBO OFFER:** Book and disc for only \$125 plus \$3 shipping.

**MORE INFO?** Contact ISCET,  
2708 West Berry St.  
Fort Worth TX 76109  
(817) 921-9101

Allow 4-6 weeks delivery when using personal checks or VISA and MasterCard. Money orders and cashiers checks processed immediately.

Amount \_\_\_\_\_ VISA  MasterCard   
 Card No. \_\_\_\_\_ Exp. \_\_\_\_\_  
 Name \_\_\_\_\_  
 Business \_\_\_\_\_  
 Address \_\_\_\_\_  
 City \_\_\_\_\_ State \_\_\_\_\_ Zip \_\_\_\_\_  
 Phone \_\_\_\_\_ Member:  ISCET;  NESDA  
 Texas residents multiply dollar value x 7% for taxes.  
 Foreign shipments please add International postage.  
 Send to: ISCET, 2708 W. Berry St., Ft. Worth TX 76109

DECEMBER 1990



# Electronics Engineers & Designers!

Take any **3** books for only **\$4<sup>95</sup>**  
(Values to \$122.40)

**SHARPEN YOUR SKILLS**—With Quality, Affordable Professional Books

## COMPUTER SCIENCE

## ENGINEERING MATH

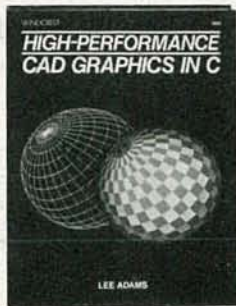

**3059** **\$34.95**  
Master the art of modeling, rendering, and animating on your IBM® PC. 524 pp. *Counts as 2.*

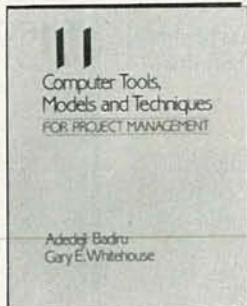

**3200** **\$32.95**  
Guidelines for enhancing software-driven project management in large or small businesses. 320 pp. *Counts as 2.*

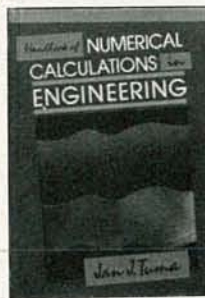

**9321** **\$49.50**  
This time-saving handbook provides problem-solving calculations for engineering design, production and research. 416 pp. *Counts as 2*



**3429** **\$29.95**  
Your source for well-developed, ready-to-use computer algorithm codes. 180 pp.



**3241P** **\$16.95**  
Get immediate access to information on calculations for all types of projects and phenomena with this handy reference. 280 pp.

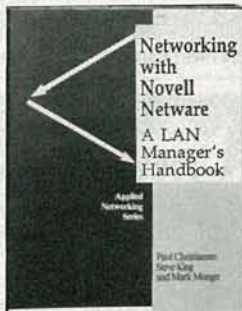

**3283** **\$28.95**  
Covers all aspects of LAN planning, installation, and operation, including standard and non-standard arrangements. 240 pp.

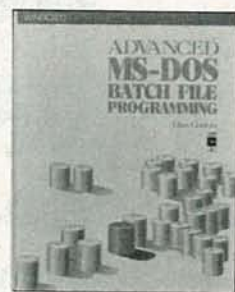

**3197P** **\$24.95**  
Provides all the information needed to begin programming with batch files. 400 pp.

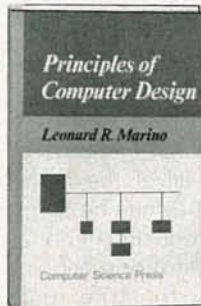

**9813** **\$39.95**  
Covers logic design, register transfer design, architecture, programming and more. 578 pp.



**3131** **\$26.95**  
Assemble your own powerful microcomputer system... it's easy and inexpensive. 224 pp.

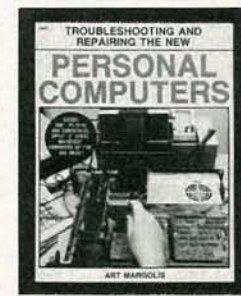

**2809** **\$29.95**  
This hands-on servicing manual covers IBM-PC/XT/AT and compatibles, MAC, Apple II series, C-64 & 128 and more. 416 pp.

## ELECTRONIC CIRCUITS



**3258** **\$27.95**  
Step-by-step instructions for troubleshooting and repairing the latest in electrical equipment. 310 pp.

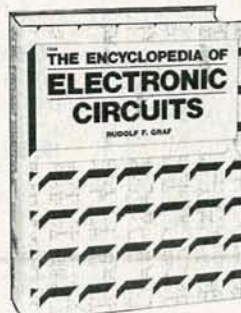

**1938** **\$60.00**  
Over 1,300 useful and versatile electronic circuit designs. 768 pp. *Counts as 2*

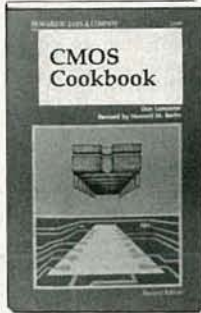

**9244P** **\$18.95**  
This revised and updated edition is both a comprehensive, industry-wide reference, and a valuable collection of project ideas. 512 pp.



**9243P** **\$12.95**  
This book will eliminate the guesswork in choosing the best circuit or tracking down malfunctions in a completed circuit. 282 pp.

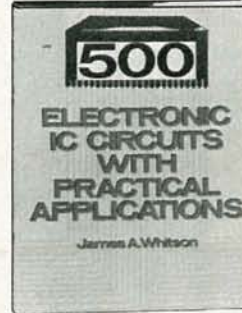

**2920** **\$29.95**  
A wealth of electronic circuits and information on building working devices. 336 pp.





**3203**      **\$44.50**  
 An indispensable guide to technology from composition to applications and testing. 400 pp. *Counts as 2*

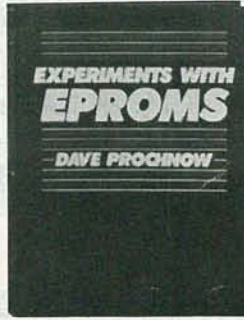

**2962P**      **\$17.95**  
 Complete schematic diagrams, parts lists, and photos for building a variety of projects. 296 pp.



**10015**      **\$42.95**  
 The most up-to-date introduction available on the many facets of ISDN. 320 pp. *Counts as 2*



**3098**      **\$44.50**  
 A comprehensive overview of CAD/CAM, CAE, and CIM concepts, capabilities and applications. 438 pp. *Counts as 2*

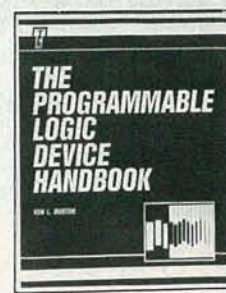

**3140**      **\$49.95**  
 Includes details on PLD technology: architectural characteristics, tech. tradeoffs, logic synthesis, software tools, development systems, and hardware. 480 pp. *Counts as 2*

**ELECTRONIC COMPONENTS**



**3199**      **\$52.00**

**3199** SMT layout and design guidelines for efficient assembly processing, inspection and repair. 180 pp. *Counts as 2*



**2672**      **\$49.50**

**2672** Linear integrated circuits—specifications, prices & data. 614 pp.



**3151**      **\$39.95**

**3151** Provides detailed insight into every aspect of the engineering design process—from the preconcept phase through the life-cycle costs and commercial applications. 334 pp. *Counts as 2*

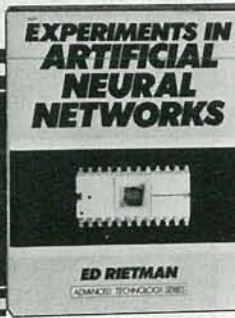

**3037**      **\$24.95**

**3037** Build your own neural networking breadboards—systems that can store and retrieve like the brain! 160 pp.

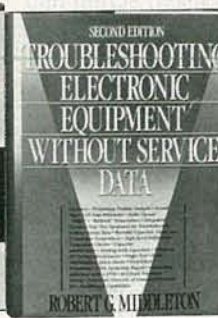

**9290**      **\$36.00**

**9290** Provides many never-before-published troubleshooting techniques and case histories. 315 pp. *Counts as 2*

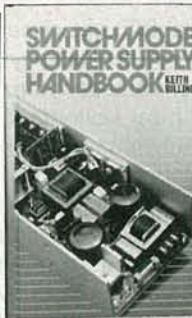

**9305**      **\$59.50**

**9305** The solution-oriented handbook for practicing engineers at all levels. Contains hundreds of informative illustrations and diagrams demonstrating key principles. 600 pp. *Counts as 3*

**How the Club Works:**

**YOUR BENEFITS:** You get 3 books for \$4.95 plus shipping & handling when you join. You keep on saving with discounts of up to 50% as a member.

**YOUR PROFESSIONAL BOOKSTORE BY MAIL:** Every 3-4 weeks, you will receive the EE&D Book Club News describing the Main Selection and Alternates, as well as bonus offers and special sales, with scores of titles to choose from.

**AUTOMATIC ORDER:** If you want the Main selection, do nothing and it will be sent to you automatically. If you prefer another selection, or no selection at all, simply indicate your choice on the reply form provided. You will have at least 10 days to decide. As a member, you agree to purchase at least 3 books within the next 2 years and may resign at any time thereafter.

**BONUS BOOKS:** Starting immediately you will be eligible for our *Bonus Book Plan* with savings of up to 80% off publishers' prices.

**IRONCLAD NO-RISK GUARANTEE:** If not satisfied with your books, return them within 10 days without obligation!

**EXCEPTIONAL QUALITY:** All books are quality publishers' editions especially selected by our Editorial Board.

All books are hardcover unless number is followed by a "P" for paperback. (Publishers' Prices Shown)

©1990 EEDBC, Blue Ridge Summit, PA 17294-0860

**SEND NO MONEY NOW!**

INTRODUCTORY 10-DAY FREE EXAMINATION



**ELECTRONICS ENGINEERS & DESIGNERS BOOK CLUB<sup>SM</sup>**

Blue Ridge Summit, PA 17294-0860

**YES!** Please accept my membership in the *Electronics Engineers & Designers Book Club* and send my 3 volumes listed below billing me \$4.95. If not satisfied, I may return the books within 10 days and have my membership cancelled. I agree to purchase 3 or more books at regular Club prices during the next 2 years, and may resign at any time thereafter. A shipping/handling charge and sales tax will be added to each order.

\_\_\_\_\_

**50% MONEY-SAVING OPTION:** I also wish to order my first Club Selection at 50% off the Publishers' price. I then need to purchase only 2 more books within the next 2 years.

\_\_\_\_\_

Name \_\_\_\_\_

Address \_\_\_\_\_

City \_\_\_\_\_

State \_\_\_\_\_ Zip \_\_\_\_\_ Phone \_\_\_\_\_

Valid for new members only. Foreign applicants will receive special ordering instructions. Canada must remit in U.S. funds. This order is subject to acceptance by the *Electronics Engineers & Designers Book Club*. DRE1290



# COMPUTER CONNECTIONS

## Electronics Workbench, an electronic's lab simulation program

JEFF HOLTZMAN

**Y**ou can throw away your solderless breadboard and spare parts junk box. Electronics Workbench (EWB) provides a full graphical simulation of an electronics lab, complete with breadboard, parts bin, and test instruments. The program allows you to build a schematic diagram of a circuit, simulate its operation, and display its output on a variety of test instruments, including a digital-volt meter (DVM), scope, eight-channel logic analyzer, Bode plotter, and so on. Building a circuit is simple and intuitive. Documenting your results is simple as well because the program provides nicely formatted printouts of everything, including the schematic, instrument readings, and parts list.

EWB comes on four floppy disks and requires about 1 megabyte of disk space, but it can run on a dual-floppy machine. You need at least 512K of RAM, a graphics monitor (Hercules, CGA, EGA, MCGA, or VGA), and a mouse. No extra memory or math coprocessor is required or used. Unfortunately, the current version of EWB costs \$650, but the company, Interactive Image Technologies of Ontario, Canada, is working on a new "personal" version that should be priced for student and hobbyist use.

EWB actually consists of separate analog and digital modules; you cannot build "mixed" circuits. The digital screen is shown in Fig. 1. When you first start the program, the central area is blank; the figure shows a simple divide-by-two circuit. The screen is divided into three major areas. Across the top is a row of test instruments, and program-control menus and icons on the right. Down the right side is the parts bin. To add a part to a circuit, you move it from the parts bin, place it where you want it, and connect it to other components. Unlike a real parts bin, there is an unlimited number of each component. The default parts bin includes

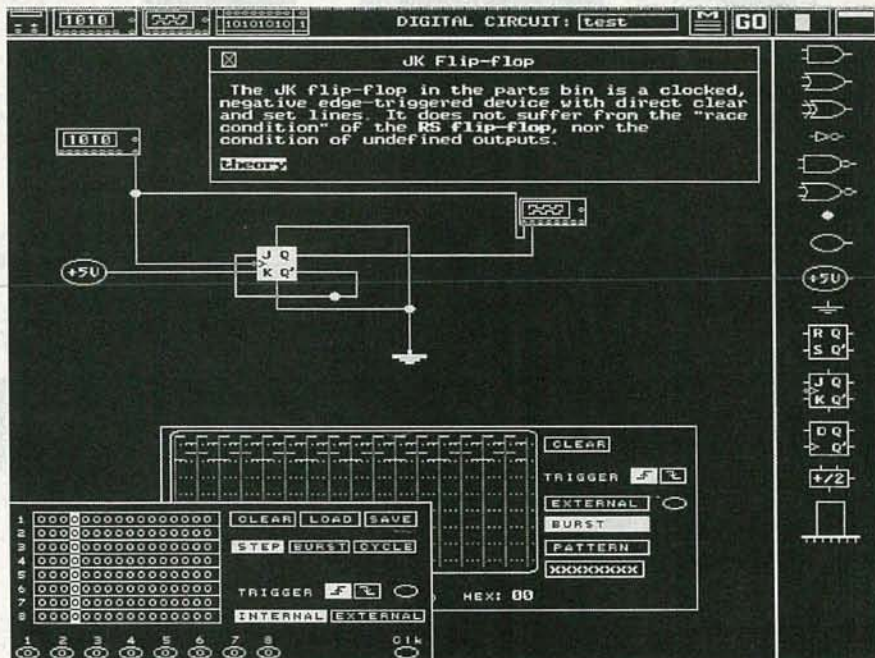

**FIG. 1—THE ELECTRONICS WORKBENCH GRAPHICALLY** simulates an electronics lab. In the digital module, you choose the components from a parts bin, build a schematic diagram on a breadboard, simulate its operation and display the output on a variety of test instruments.

items such as AND, NAND, OR, NOR, XOR, and NOT gates, as well as D, RS, and JK flip-flops. In addition, there is a half-adder, seven-segment LED display, discrete LED's, a ground, and +5-volt sources.

You can even create your own parts using EWB's macro feature. For example, you might combine six hex-inverters and call the result a 7404. You can load and save parts bins independently of your circuits. You can

give each part a label, and in the analog module, a value. Display of labels and values is normally disabled, but you can turn either or both on. The designations, however, often obscure the parts.

In Fig. 1, note that the  $\bar{K}$  input is connected to +5 volts, the  $\bar{Q}$  output is connected to the J input, and the CLR and PR inputs are grounded. Driving the  $\bar{CLK}$  input is a pulse generator, with a zoomed-out view appearing in the lower left corner of the screen. The CLK output of the pulse generator drives the test circuit. Note, however, that the generator actually has eight outputs, and you can define 16-bit patterns to drive those outputs. Defining the bit patterns is somewhat awkward because you have to type in 1's and 0's; it would be easier and more logical simply to toggle a bit each time you clicked on it with the mouse. However, you can load and save bit patterns to disk files. The pulse generator has three different

### ITEMS DISCUSSED

- Electronics Workbench (\$650), Interactive Image Technologies, Ltd., 49 Bathurst Street, Suite 401, Toronto, Ontario, Canada M5V 2P2. (416) 361-0333.  
CIRCLE 41 ON FREE INFORMATION CARD

- PC System Programming (\$59.95), Turbo Pascal Internals (\$49.95), Abacus, 5370 52nd Street S.E., Grand Rapids, MI 49512. (616) 698-0330.  
CIRCLE 42 ON FREE INFORMATION CARD



# R-E Computer Admart

Rates: Ads are 2 1/4" x 2 7/8". One insertion \$950. Six insertions \$925 each. Twelve insertions \$895 each. Closing date same as regular rate card. Send order with remittance to **Computer Admart**, Radio Electronics Magazine, 500-B Bi-County Blvd., Farmingdale, NY 11735. Direct telephone inquiries to Arline Fishman, area code-516-293-3000. *Only 100% Computer ads are accepted for this Admart.*

## GETTING THE MOST FROM YOUR PRINTER

Getting The Most From Your Printer



**BP181**—It is probable that 80% of dot-matrix printer users only ever use 20% of the features offered by their printers. This book will help you unlock the special features and capabilities that you probably don't even know exist. To order your copy send **\$6.95 plus \$1.50 for shipping** in the U.S. to **Electronic Technology Today Inc., P.O. Box 240, Massapequa Park, NY 11762-0240.**

## SECRETS OF THE COMMODORE 64

Secrets of the COMMODORE 64



**BP135**—A beginners guide to the Commodore 64 presents masses of useful data and programming tips, as well as describing how to get the best from the powerful sound and graphics facilities. We look at how the memory is organized, random numbers and ways of generating them, graphics-color-and simple animation, and even a chapter on machine code. Get your copy today. Send **\$5.00 plus \$1.25 for shipping** in the U.S. to **Electronic Technology Today Inc., P.O. Box 240, Massapequa Park, NY 11762-0240.**

## ICs PROMPT DELIVERY!!!

SAME DAY SHIPPING (USUALLY)  
QUANTITY ONE PRICES SHOWN FOR SEPT. 30, 1990

OUTSIDE OKLAHOMA NO SALES TAX

DYNAMIC RAM		
4M Board for hp LJ's w/2MB		\$173.00
SIMM 2M IBM PS-2 Model 70		185.00
SIMM 1M AST Prem386 33Mhz		135.00
SIMM 1Mx9	80 ns	59.00
SIMM 256Kx9	100 ns	20.00
1Mbit	1Mx1 60 ns	11.95
1Mbit	1Mx1 80 ns	6.15
41256	256Kx1 80 ns	2.90
41256	256Kx1 100 ns	2.10
41256	256Kx1 120 ns	1.95
4464	64Kx4 100 ns	2.20
41264*	64Kx4 100 ns	5.95
EPROM		
27C1000	128Kx8 200 ns	\$15.00
27512	64Kx8 200 ns	7.10
27256	32Kx8 200 ns	5.40
27128	16Kx8 250 ns	3.75
STATIC RAM		
62256P-10	32Kx8 100 ns	\$6.50
6264P-12	8Kx8 120 ns	4.25

OPEN 6 DAYS, 7:30 AM-10 PM. SHIP VIA FED-EX ON SAT.

SAT DEL ON FED-EX ORDERS RECEIVED BY: TH: 5:45 PM, FR: 12:00 PM, COD AVAILABLE. MasterCard VISA or UPS CASH COD. MICROPROCESSORS UNLIMITED, INC. 24,000 S. Peoria Ave. BEGGS, OK, 74421. (918) 267-4961. No minimum order. Please note: prices subject to change! Shipping: insurance extra, up to \$1 for packing materials.

CIRCLE 61 ON FREE INFORMATION CARD

modes: 1) single step, in which one bit is delivered each time you click on the step button; 2) burst, in which all 16 bits are delivered sequentially; and 3) cycle, in which all the bits are output repetitively.

The output of the flip-flop is connected to a logic analyzer, a zoomed-out view appears *behind* and the pulse generator. The pulse generator drives channel one (shown in the upper trace) of the logic analyzer, the output of the flip-flop drives channel two (lower trace). Logic-analyzer options include positive, negative, and external triggering, and a display of the waveform, either as received or after receiving a pattern.

### On-line help

EWB includes a top-notch on-line hypertext-based help system. Note that the text box of Fig. 1 describes the "JK Flip-flop". To get that type of description, you simply highlight a component and press F1. In that text box, the word *theory* is highlighted. You can click on it to receive a more-detailed description. It's hard to see in the figure, but "RS flip-flop" is highlighted as well. You can also click on it for comparative information. The help texts are brief summaries, so they are not really substitutes for full textbook explanations. However, the manual includes complete instructions for modifying and adding to the built-in

help texts.

Moving from right to left, the icons in the upper right corner of the screen allow you to scroll through the parts bin, scroll the screen, start simulation, and drop down a command menu. The command menu allows you to get help; cut, copy, move, and rotate components; set preferences; and load, save, and print files. All

common laser and dot-matrix printers are supported.

Moving from left to right, the icons in the upper left corner represent test instruments. First is a DVM, then the pulse generator, then the logic analyzer, then the "truth table." The latter converts digital circuits among three different representations; a circuit diagram, a truth table, and a

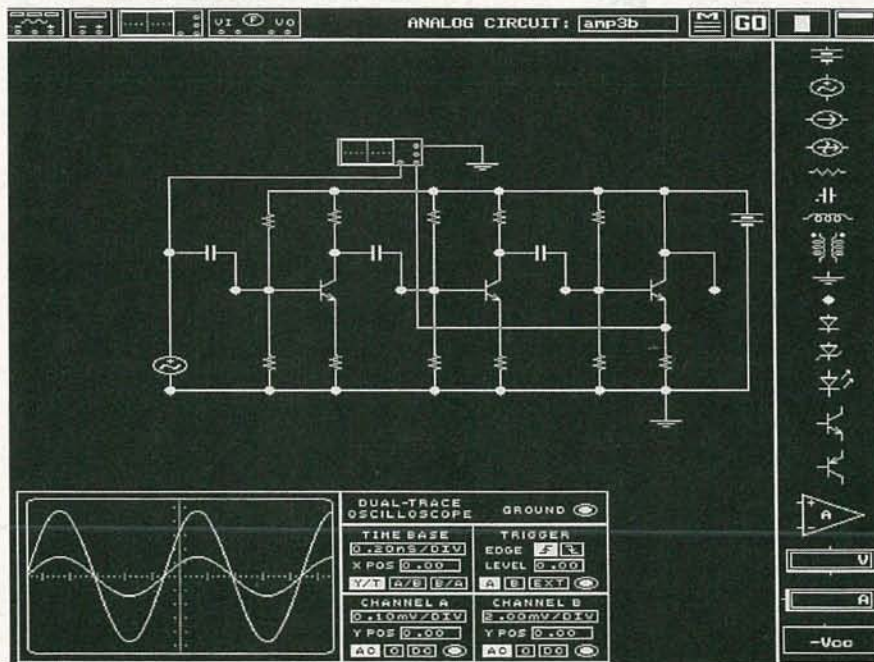

**FIG. 2**—EWB's ANALOG MODULE IS SIMILAR to the digital module except there are more components and different test instruments. Meter characteristics are ideal, but you can change their impedances to simulate real-world operation.



## SPECIAL FROM ETT

**PCP101—PRACTICAL DIGITAL ELECTRONICS HANDBOOK ... \$9.95.** Introduces digital circuits, logic gates, bistables and timers, as well as micro-processors, memory and input/output devices. Special section on digital test gear projects.



**PCP102—INTRODUCING DIGITAL AUDIO ... \$9.95** Shows what is involved in the digital part of audio signals, particularly in the newest devices such as CD, DAT and sampling. Bridges the gap of understanding for the technician and enthusiast.



**PCP103—PRACTICAL MIDI HANDBOOK ... \$9.95.** Covers all MIDI based equipment you can use—keyboards, drum machines, sequencers, effects units, mixers, drum pads and guitars. Also a section on computer music that covers software and more.



**PCP104—ELECTRONICS BUILD & LEARN, Second Edition ... \$9.95.** You start by assembling a circuit demonstrator that is then used to build and investigate a variety of useful circuits including oscillators, multi-vibrators, bistables and logic circuits.



**PCP105—MAKE MONEY FROM HOME RECORDING ... \$10.00.** Now that you've spent all that money on all that recording gear, wouldn't it be nice to get some of it back? Well here's the book that can show you how.



**PCP106—SYNTHESIZERS FOR MUSICIANS ... \$10.00.** All current popular forms of synthesis explained; LA, additive, phase distortion, FM and sampling. Get the sounds you want from your synth. Written especially for musicians.



MAIL TO: Electronic Technology Today, Inc.  
P.O. Box 240  
Massapequa Park, NY 11762-0240

### SHIPPING CHARGES IN USA AND CANADA

\$0.01 to \$5.00	\$1.25	\$30.01 to \$40.00	\$5.00
\$5.01 to 10.00	\$2.00	\$40.01 to \$50.00	\$6.00
\$10.01 to \$20.00	\$3.00	\$50.01 and above	\$7.50
\$20.01 to \$30.00	\$4.00		

**SORRY, No orders accepted outside of USA and Canada**

Total price of merchandise	\$	_____
Shipping (see chart)	\$	_____
Subtotal	\$	_____
Sales Tax (NYS only)	\$	_____
Total Enclosed	\$	_____

Name \_\_\_\_\_  
Address \_\_\_\_\_  
City \_\_\_\_\_ State \_\_\_\_\_ Zip \_\_\_\_\_

Boolean expression. You can create a circuit by filling in a truth table. On the other hand, you could attach it to a working circuit, get a truth table, and verify your design. EWB uses the Quine-McCluskey synthesis algorithm when going from a truth table to a Boolean expression.

You can place only one copy of each test instrument into a circuit, but after running a simulation, you can measure signals at various points as long as you don't change the circuit itself.

### Analog module

The analog module works similarly, but there are more components and different test instruments. Components include resistor, capacitor, inductor, transformer, NPN and PNP transistors (but no FET's or MOS devices), diode, Zener diode, op-amp, battery, AC and DC sources. Test instruments include a function generator, DVM, dual-channel scope, and Bode plotter.

There are volt meters and ammeters in the parts bin; multiple copies of each may be inserted into a circuit. The function generator provides sine, square, and triangular waves; the frequency can range from 1 Hz to 999 MHz; you can also adjust the duty cycle, symmetry, amplitude, and DC offset. The DVM measures current, voltage, resistance, and dB. By default, meter characteristics are ideal (infinite impedance for voltage measurement, zero for current), but you can vary characteristics to simulate real-world conditions, and that's a nice touch. Similarly, you can alter the operating parameters of the active components, and load and save different models of the same component.

### Conclusion

EWB is a wonderful program. It is limited in that you can't model very large circuits, nor (in the digital module) can you account for propagation delays, so you would never be able to model a high-speed 32-bit wide 486 bus.

But that's not what EWB is intended for. It's really intended for first-year college or university students coming to grips with the fundamentals, and in that sense, works admirably. At \$650, EWB is much too expensive for individual purchase. I have discussed that with Interactive Images,

and they are working on a lower-cost version.

I'd strongly urge you to write to the company as well. If the company sees a great deal of interest in the product, they would be more inclined to believe that they can make up through volume what they lose in the per-piece price.

### Books from Abacus Press

I have just had the pleasure of perusing a couple of thick, dense books written by Michael Tischer and published by Abacus press: *PC System Programming* and *Turbo Pascal Internals*. Tischer's stated goal in *PC System Programming* is to provide a complete system overview, including detailed information on hardware, BIOS, and DOS.

Although that is an ambitious goal, Tischer for the most part manages to achieve it. The book consists of more than 900 pages of lucidly presented information with lots of example programs in assembler, C, Basic, and Pascal. All programs listed in the book (about 1 MB total) are included on a pair of floppy disks, which eliminates tedious and error-prone typing.

For example, the book contains an excellent discussion of device drivers (with examples), a set of routines for determining video-card type, using extended and expanded memory, determining CPU type, hard-disk partitioning, and a whole lot more. All in all, these books put to shame certain well-known volumes by certain well-known industry personalities. The Pascal book provides equal meat. For example, Tischer shows disassembled versions of standard Turbo functions and procedures, illustrating why DEC and INC are more efficient than PRED and SUCC, as well as  $X := X + 1$ .

Major topics include a complete window manager, a swap unit that allows your Turbo program to shell to DOS with a maximum amount of memory by leaving only a 1K stub behind, and another unit that allows you to build a multi-tasking system under Turbo. *Turbo Pascal Internals* has about 750 pages, and also comes with about 1 MB of source code. Neither book is for the beginner. However, if you've already mastered the basics of PC hardware and software, these books can provide a one-stop source for moving up to Guru status. **R-E**



# MEMORY QUIZ

Find out how much you know about random access memory.

ALVIN G. SYDNOR

1—Most popular RAM devices are available in two types, which are:

(a) metal-oxide semiconductor (MOS)

- (b) 64K bytes
- (c) bipolar
- (d) high-power

2—In dynamic memories, each storage cell is composed of:

- (a) PNP IC's
- (b) a single MOS
- (c) a MOS-processed capacitor
- (d) silicon chips

3—The term "performance" relates to how fast the RAM can operate in a given environment. That parameter is usually rated in terms of:

- (a) bits per second
- (b) transfer time
- (c) time-temperature
- (d) access time

4—Bipolar memories offer very high performance but have the disadvantage of:

- (a) being very bulky
- (b) operating at high voltage levels
- (c) high power dissipation
- (d) limited storage

5—The great advantage of dynamic RAM's (DRAM) lies in:

- (a) long-term memory storage capabilities
- (b) the small size of their storage cells
- (c) low-voltage operation
- (d) a long "refresh" time

6—The term "RAM organization" refers to the:

- (a) physical size of the chip
- (b) method of manufacturing
- (c) grouping of the cells
- (d) width of the memory word

RAM organization refers to the width of the memory word. During their early inception, RAM's were organized as  $n \times k$  bits.

1—(a and c) The two current popular RAM devices use bipolar and MOS technologies.  
2—(b and c) In dynamic memories, each storage cell is composed of a single metal-oxide semiconductor field-effect transistor (MOSFET) and a tiny MOS-processed capacitor.  
3—(d) Generally, the term performance relates to how fast the RAM can operate in a given system environment. This parameter is usually rated in terms of access time; that is, how long it takes the RAM to respond to a read or write command from the CPU.  
4—(a and c) Bipolar memories offer very-high-performance capabilities, but are fairly bulky and dissipate significantly more power than the average MOS memory device.  
5—(b) The great advantage of dynamic RAM lies in the small size of their storage cells, which makes it possible to achieve high densities. This also significantly reduces the cost compared to that of static RAM.  
6—(d) Depending upon the organization of the device, the required number of active RAM's can vary.

Answers

## SUPER LONG PLAY TAPE RECORDERS

12 Hour Model —  
USES 120 TAPE  
\$119.00\*

Modified Panasonic Slimline, high quality AC-DC provide 6 continuous hours of quality recording & playback on each side of cassette for 12 hours total. Includes • Voice level control • Digital counter, etc. TDK - 120 Cassette Furnished.



### PHONE RECORDING ADAPTER

Records calls automatically. All Solid state connects to your telephone jack and tape recorder. Starts recording when phone is lifted. Stops when you hang up. \$28.50\*  
FCC APPROVED



### VOX VOICE ACTIVATED CONTROL SWITCH

Solid state. Self contained. Adjustable sensitivity. Voices or other sounds automatically activate and control recorder. Uses either recorder or remote mike. \$28.50\*  
FCC APPROVED



\*Add for ship & hdg. Phone Adapter & Vox \$1.50 ea. Recorders \$4.00 ea. Cal. Res. add tax. Mail order. VISA, MIC, COD's OK. Money Back Guarantee. Qty. disc. avail... Dealer Inquiries Invited. Free data.  
AMC SALES INC. Dept. A 9335 Lubec St. Box 928. Downey, CA. 90241. Phone (213) 869-8519 FAX (213) 923-1478

CIRCLE 108 ON FREE INFORMATION CARD



MEANS A LOT TO YOU  
Because We Provide

- Better Facilities
- Better Quality
- Better Service
- Better Prices

## ON JAN CRYSTALS

Radio Control	Microprocessor
Industry	Telecommunications
Marine	Satellite
Amateur	Two-Way

WRITE OR CALL FOR FREE CATALOG

## JAN CRYSTALS

P.O. Box 06017  
Ft. Myers, FL 33906



(813) 936-2397



TOLL FREE 1-800-526-9825  
FAX ORDERS 1-813-936-3750

CIRCLE 104 ON FREE INFORMATION CARD

# Be an FCC LICENSED ELECTRONIC TECHNICIAN!



Earn up to \$30 an hour and more!

Learn at home in spare time. No previous experience needed!

No costly school. No commuting to class. The Original Home-Study course prepares you for the "FCC Commercial Radiotelephone License." This valuable license is your professional "ticket" to thousands of exciting jobs in Communications, Radio-TV, Microwave, Maritime, Radar, Avionics and more...even start your own business! You don't need a college degree to qualify, but you do need an FCC License.

**No Need to Quit Your Job or Go To School**  
This proven course is easy, fast and low cost! **GUARANTEED PASS**—You get your FCC License or money refunded. **Send for FREE facts now. MAIL COUPON TODAY!**

### COMMAND PRODUCTIONS

FCC LICENSE TRAINING, Dept. 90  
P.O. Box 2824, San Francisco, CA 94126  
Please rush FREE details immediately!

NAME \_\_\_\_\_  
ADDRESS \_\_\_\_\_  
CITY \_\_\_\_\_ STATE \_\_\_\_\_ ZIP \_\_\_\_\_

DECEMBER 1990

89



# LEARN VCR

## CLEANING/MAINTENANCE/REPAIR

EARN UP TO \$1000 A WEEK, WORKING PART TIME FROM YOUR OWN HOME!



Secrets Revealed!

NO Special Tools or Equipment Needed.

EARN UP TO \$60 AN HOUR AND MORE!

### THE MONEY MAKING OPPORTUNITY OF THE 1990'S

IF you are able to work with common small hand tools, and are familiar with basic electronics (i.e. able to use voltmeter, understand DC electronics) . . .

IF you possess average mechanical ability, and have a VCR on which to practice and learn. . . . then we can teach YOU VCR maintenance and repair!

**FACT:** up to 90% of ALL VCR malfunctions are due to simple MECHANICAL or ELECTRO-MECHANICAL breakdowns!

**FACT:** over 77 million VCRs in use today nationwide! Average VCR needs service or repair every 12 to 18 months!

Viejo's 400 PAGE TRAINING MANUAL (over 500 photos and illustrations) and AWARD-WINNING VIDEO TRAINING TAPE reveals the SECRETS of VCR maintenance and repair—"real world" information that is NOT available elsewhere!

Also includes all the info you'll need regarding the BUSINESS-SIDE of running a successful service operation!

FREE INFORMATION  
CALL TOLL-FREE 1-800-537-0589

Or write to: Viejo Publications Inc.  
5329 Fountain Ave.  
Los Angeles, CA 90029 Dept. RE

CIRCLE 181 ON FREE INFORMATION CARD

## Get A Complete Course In

# ELECTRONIC ENGINEERING

8 volumes, over 2000 pages, including all necessary math and physics. 29 examinations to help you gauge your personal progress. A truly great learning experience.

Prepare now to take advantage of the growing demand for people able to work at the engineering level.

Ask for our brochure giving complete details of content. Use your free information card number, or write us directly. \$99.95, Postage Included. Satisfaction guaranteed or money refunded.



**Banner  
Technical  
Books, Inc.**

1203 Grant Ave.  
Rockford, IL 61103

CIRCLE 67 ON FREE INFORMATION CARD

## CHRISTMAS CARD

continued from page 47

the microphone causes a voltage to appear. Do not increase the setting until R17 through R20 are adjusted so as to give a complete range through each bargraph. The best bet for making these adjustments is to play a stereo audio source (actually, any source will do) at a normal listening level. Simply adjust the potentiometers for what you consider to be a pleasing or most Christmas-like interpretation of the sound.

If you have any problems with the device, the first thing to do is decrease the setting (counterclockwise) of all the potentiometers. A filter that still oscillates after decreasing the potentiometers most likely has an incorrect component or one that does not meet its tolerance.

For high-Q versions of the circuit, sometimes the component tolerance is such that the filter will begin to oscillate when presented with a large input. If that's the case, all you must do is interchange the two filter capacitors; this old technician's trick usually works, assuming that there aren't any problems with the other components.

If you still have problems, check that the analog ground is stable. A variation on that line will cause serious problems with the operation of the unit. If you cannot find the problem, the best thing to do is to shut off the display by lifting one lead of both R1 and D5. With the load of the display removed, it's easier to locate problems.

The finished, working board can be installed in any kind of housing you like, although the custom black metal frame adds a nice touch, as does the mat that keeps the circuitry from view. After installing the unit in the frame you may want to readjust the potentiometers, since the frame and front glass seem to couple the microphone to the surrounding air. Vibrations picked up by the device will also produce a display; a fan operating nearby is almost always displayed. Have fun, and don't forget to have a merry Christmas, as well!

R-E

## DRAWING BOARD

continued from page 79

lower four bits of the data port associated with the parallel port you're using (LPT1 in this example).

Since the four most significant bits at the data port aren't being used (at the moment), it doesn't matter what value we give them. I'm mentioning this only because the OUT instruction will send a full byte out to the port. An instruction such as OUT 956,1 will send the same four least-significant bits to the port as an OUT 956,177. Those two numbers may look very different but the similarity between the two shows up when you think of the numbers in hex instead of decimal.

Since you want the lower half of the byte to be a 1h, any number can be stuffed in the upper half of the byte. A 177 decimal is B1h, so it will be the same (as far as our circuit is concerned) as a 01h, 21h, 31h, and so on.

The output of the 5088 can be fed into the line input of a standard amplifier or, if you're a DTMF freak, you can probably connect it to a set of high-impedance headphones. There's no guarantee of the initial state of the lower four bits so there's no telling what tone you're going to hear when you first connect the circuit to the port.

If you've wired up everything properly, you'll hear the tones change as you send different data out the port but, as you may have noticed, all the possible values you can put on the lower four bits are legal input codes for the 5088. That means there's nothing you can send to the port to shut the circuit off. While that won't cause any electronic problems, it can still cause a bit of brain damage. There's an easy way around that however, since the TONE ENABLE input (pin 2) is specifically designed to take care of the problem.

You can tie that pin to one of the other data lines—bit 7 is a good choice—and use that data line to turn the chip on and off. A high on the data line will enable tone generation and a low will disable it, no matter what data is being sent on the lower four bits.

When we get together next time we'll finish this thing off by adding some circuitry to control the phone line, a telephone, and a few other things. See you then.

R-E



# MARKET CENTER

## FOR SALE

**DESCRAMBLERS.** All brands. Special: Combo Jerrold 400 and SB3 \$165.00. Complete cable descrambler kit \$39.00. Complete satellite descrambler kit \$45.00. Free catalog. **MJM INDUSTRY**, Box 531, Bronx, NY 10461-0208.

**TUBES:** "oldest," "latest." Parts and schematics. SASE for lists. **STEINMETZ**, 7519 Maplewood Ave., RE, Hammond, IN 46324.

**ENGINEERING** software, PC/MSDOS. Hobbyists — students — engineers. Circuit design \$49.00, PCB layout \$99.00, Logic simulation \$29.00, FFT analysis \$69.00, Mathematics \$39.00, Circuit analysis \$29.00. Call or write for free catalog. (614) 491-0832, **BSOFT SOFTWARE**, 444 Colton Rd., Columbus, OH 43207.

**RESTRICTED** technical information: Electronic surveillance, schematics, locksmithing, covert sciences, hacking, etc. **Huge selection. Free brochures.** **MENTOR-Z**, Drawer 1549, Asbury Park, NJ 07712.

## CABLE TV DESCRAMBLERS! BARGAIN HEADQUARTERS!



- JERROLD™ • TOCOM • HAMLIN
- OAK • ZENITH
- SCIENTIFIC ATLANTA

6 month warranty! We ship C.O.D.!  
Lowest retail/wholesale prices!

### FREE CATALOG:

Global Cable Network  
1032 Irving St. Suite 109  
S.F., CA 94122

NO CALIFORNIA SALES!!!

**ORDER TODAY! 800-327-8544**

**CABLE TV converters:** Jerrold, Oak, Scientific Atlantic, Zenith & many others. "New MTS" stereo add-on: mute & volume. Ideal for 400 and 450 owners! 1 (800) 826-7623, Amex, Visa, M/C accepted. **B & B INC.**, 4030 Beau-D-Rue Drive, Eagan, MN 55122.

**TUBES**, new, up to 90% off, SASE, **KIRBY**, 298 West Carmel Drive, Carmel, IN 46032.

**CABLE TV converters and descramblers.** We sell only the best. Low prices. SB-3 \$79.00. We ship C.O.D. Free catalog. **ACE PRODUCTS**, PO Box 582, Dept. E, Saco, ME 04072. 1 (800) 234-0726.

## CB RADIO OWNERS!

We specialize in a wide variety of technical information, parts and services for CB radios. 10-Meter and FM conversion kits, repair books, plans, high-performance accessories. Thousands of satisfied customers since 1976! Catalog \$2.

**CBC INTERNATIONAL**  
P.O. BOX 31500RE, PHOENIX, AZ 85046

**PHOTOFACT** folders under #1400 \$4.00. Others \$6.00. Postpaid. **LOEB**, 414 Chestnut Lane, East Meadow, NY 11554.

**FM 2-way, CB/amateur, scanners, radar detectors, auto alarm, catalog \$1.00, RAYS**, PO Box 14862, Fort Worth, TX 76117.

**CABLE** converters, all major brands. Info & orders 1 (800) 782-0552. **FREWAY, INC.**, SMP PO# 5036, Burnsville, MN 55337.

**S-A** test chips. Enables full tiering. 8550: \$22.00 each/10 \$180.00. 8500: \$20.00 each/10 \$160.00. Money order or COD. **R.V.**, Box 771, Ridgefield, CT 06877.

**\$1.99 software** for IBM Compatibles. Quality at affordable prices! Huge selection: business, games, graphics, utilities, database, spreadsheets. Free catalog. **AULT**, 1556 Halford Avenue, #242, Santa Clara, CA 95051.

**ROBOTICS** software, PC/MSDOS. Explore computer vision, sonar sensing. Free brochure. **ROBOTS ETC.**, Box 122, Tempe, AZ 85280.

**IS it true** Jeeps for \$44.00 through the U.S. Gov't? Call for facts! (504) 649-5745 Ext. S-5192.

**ARTIFICIAL** intelligence for IBM/PC. "Uncanny and fun" — N.Y. Times. Free 32-page catalog. **THINKING SOFTWARE**, 46-16 65th Place, Woodside, NY 11377.

## FREE CATALOG

**FAMOUS "FIRESTIK" BRAND CB ANTENNAS AND ACCESSORIES. QUALITY PRODUCTS FOR THE SERIOUS CB'er. SINCE 1962**

**FIRESTIK ANTENNA COMPANY**  
2614 EAST ADAMS  
PHOENIX, ARIZONA 85034

**PROGRAMMABLE** stepper motor drive & control for under \$100, IBM PC/XT compatible, **Commodore 64**, or other with 25 pin parallel port. PCB, interface, & software. Send for detailed literature to: **MASE**, R.D. #2 Box 166, Mohrsville, PA 19541.

**PRINTED** circuit boards etched & drilled. Free delivery. **K & F ELECTRONICS, INC.**, 33041 Groesbeck, Fraser, MI 48026. (313) 294-8720.

**LASERS.** 1mw to 2kw, worlds largest selection of new & used surplus. Free catalog. **MWK INDUSTRIES**, 1269 Pomona Road, Corona, CA 91720. (714) 278-0563.

**CABLE** descramblers (Jerrold) from \$40.00. Tocom VIP test chip. Fully activates unit. Also Zenith test board. Fully activates Z-Tacs. \$50.00. Call (213) 867-0081.



### Quality Microwave TV Antennas

**WIRELESS CABLE - IFTS - MMDS - Amateur TV**  
Ultra High Gain 50db(+) • Tuneable 1.9 to 2.7 Ghz.  
• 36-Channel System Complete \$149.95  
• 12-Channel System Complete \$114.95  
• Call or write (SASE) for "FREE" Catalog

**PHILLIPS-TECH ELECTRONICS**  
P.O. Box 8533 • Scottsdale, AZ 85252  
(602) 947-7700 (\$3.00 Credit all phone orders)  
MasterCard • Visa • COD's • Quantity Pricing

**TEST** equipment pre-owned now at affordable prices. Signal generators from \$50.00. Oscilloscopes from \$50.00. Other equipment, including manuals available. Send \$1.00 for catalog, refund on 1st order. **J.B. ELECTRONICS**, 3446 Dempster, Skokie, IL 60076. (708) 982-1973.

**T.V. notch** filters, surveillance equipment, brochure \$1.00. **D.K. VIDEO**, Box 63/6025, Margate, FL 33063. (305) 752-9202.

**MINIATURE** electronics like James Bond. Catalog \$4.00, refundable. **F & P ENTERPRISES**, Box 51272, Palo Alto, CA 94303-L.

**TOCOM** VIP converters w/remote from \$279.00. Tocom super chips turn on everything, \$69.00 each. Phone (219) 935-4128.

**DESCRAMBLERS**, below wholesale prices, all brands, example **RTC-56** combo \$150.00, **M35B** \$39.00, full warranty, CODs welcome, **MOUNT HOOD ELECTRONICS** (503) 253-0459.

**GREAT** buys! Surplus prices, transformers, tubes, fans 12VDC, stepping motors, vacuum pump, magnet wire, braid, LSASE, **FERTIK'S**, 5400 Ella, Phila., PA 19120.

## WIRELESS CABLE RECEIVERS 1.9 TO 2.7 GHz



30 CH PARABOLIC DISH SYSTEM \$173.90  
30 CH ROD ANTENNA SYSTEM \$193.90  
30 CH CRYSTAL CONTROLLED SYSTEM \$294.95  
**SUN MICROWAVE INT'L. INC.** SEND \$1.00 FOR  
P.O. BOX #34522 CATALOG ON THESE  
PHOENIX, AZ. 85067 AND OTHER FINE  
(602) 230-0640 VIDEO PRODUCTS  
QUANTITY DISCOUNTS

MEMBER OF THE BETTER BUSINESS BUREAU

**CALLER ID** unit — identifies the phone number of incoming calls on a display before answering the phone. **E D E**, PO Box 337, Buffalo, NY 14226. (716) 691-3476.

**CABLE TV** converters & descramblers for Jerrold and Scientific Atlanta. Low prices, one year warranty. We ship COD. **BAY STATE ELECTRONICS**, PO Box 103, Boston, MA 02188. 1 (800) 359-9806.

**BLACK** market, hacking, phreaking, weapons, electronic surveillance, communications, more. Hardware, software, plans, kits, books. \$1.00 catalog: **OMEGATECH**, PO Box 8789C, Woodlands, TX 77387.

## CABLE TV CONVERTERS WHY PAY A HIGH MONTHLY FEE?

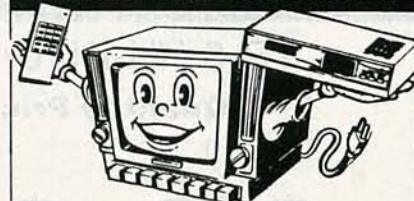

All Jerrold, Oak, Hamlin, Zenith, Scientific Atlanta, Magnavox and all specialized cable equipment available for shipment within 24 hours. For fast service MC / VISA or C.O.D. telephone orders accepted (800) 648-3030 60 Day Guarantee (Quantity Discounts) 8 A.M. to 5 P.M. C.S.T. **CLOSED WEEK-ENDS.** Send self-addressed Stamped envelope (60¢ postage) for Catalog.

**MIDWEST ELECTRONICS INC.**

P.O. Box 5000  
Suite 311 (R)  
Carpentersville, IL 60010

No Illinois Orders Accepted.

**LOST** control of your home entertainment center? Send for a free brochure of innovative, remote controlled switching products to: **INFRACON**, Dept. RE, Box 1205, Richardson, TX 75085-1205. (214) 437-3366.

**SCREWDRIEVERS:** put a thick piece of latex rubber on your shaft. For safer, smoother screwing. Enclose \$5.95 per set, offer #102. **M & M PRODUCTIONS**, PO Box 151, Waldron, IN 46182-0151. Please include \$2.00 S/H.

**TOCOM** VIP test chip with Torx #7 wrench \$45.00. **R&S** (817) 293-4113. No Texas sales.



## Cable Descramblers

New Auto Tri-Bi guaranteed no flashing \$165.00

SB-3.....	\$99.00	ZENITH SUPER	
TRIMODE.....	\$109.00	SAAVI.....	\$199.00
HAMLIN.....	\$99.00	TOCOM.....	\$319.00
SCIENTIFIC.....		EAGLE.....	\$119.00
ATLANTA.....	\$119.00	COPY GUARD.....	\$59.95
OAK M35B.....	\$99.00	STARGATE 2000.....	\$88.00
ZENITH.....	\$175.00		

M.D. Electronics will match or beat any advertised wholesale or retail price.

Your best buys and warranties for cable converters and descramblers start with a FREE catalog from MD

For Information Call

402-554-0417

To order or request a free catalog

1-800-624-1150



**M.D. ELECTRONICS**

875 SO. 72nd St.  
Omaha, NE 68114

BY ORDERING CABLE TV EQUIPMENT FROM M.D. ELECTRONICS THE PURCHASER AGREES TO COMPLY WITH ALL STATE AND FEDERAL LAWS REGARDING PRIVATE OWNERSHIP OF CABLE TV EQUIPMENT. IF YOU ARE UNSURE OF THESE LAWS CHECK WITH YOUR LOCAL OFFICIALS.

CIRCLE 53 ON FREE INFORMATION CARD

## EXCELLERATOR™ Series

CABLE CONVERTERS  
WHEN QUALITY COUNTS



New Dynatrack™ fine tuning provides unmatched picture quality  
550 Mhz tuner provides 83 channel capacity  
Sleep timer for automatic shut off within 15-90 minutes  
2/3 switchable HRC / IRC / Standard Switchable  
2 Year warranty, Last channel recall, Favorite channel select, Scan  
Double vented high efficiency transformer for cool performance  
Stargate-2001 \$99.00

Stargate-550XL \$119.00 With Volume Control

Don't settle for anything less.



C.O.D.

PROTOQUICK Z8, single board computer with prototype area, \$69.00. **SOFTWARE SCIENCE**, 3750 Roundbottom Road, Cincinnati, OH 45244. (513) 561-2060.

## FLUKE SUPER SALE

Model 73 ...	\$ 68	Model 83 ...	\$180	VISA
Model 75 ...	\$ 99	Model 85 ...	\$208	M/C
Model 77 ...	\$135	Model 87 ...	\$246	

▲ NEW! Model 45 ... \$535 ▼

**KELVIN Electronics**

7 Fairchild Ave. Plainville, NY 11803

(516) 349-7620 (800) 645-9212



RADIO tubes, parts. Extensive listings. \$1.00 (refundable). **DIERS**, 4276-E6 North 50th Street, Milwaukee, WI 53216-1313.

BOOKS on Tesla coils, lasers, robotics, electronics, computers & more! Write: Free catalog, Box 596-R, Logan, Utah 84321. 1 (800) 359-0466.

FREE catalog: Save hundreds on sought after electronic, electro mechanical, and computer related hardware and components — including hard-to-find items. Call toll free: 1 (800) 776-3700. **AMERICAN DESIGN COMPONENTS/Dept.** 119-120, 815 Fairview Avenue, Fairview, NJ 07022.

## CABLE TV "BOXES"

Converters — Descramblers  
Remote Controls — Accessories

- \* Guaranteed Best Prices \*
- \* 1 Year Warranty — C.O.D.'s \*
- \* Immediate Shipping \*
- \* FREE CATALOG \*

Call or Write

**TRANS-WORLD CABLE CO.**

12062 Southwest 117th Court, Suite 126

Miami, Florida 33186

1-800-442-9333



# CABLE TV

TB-3 (Tri-Bi) or SA-3

Quantity Prices

10

20

**\$48.**

Each

**\$43.**

Each

50

100

**\$39.**

Each

**\$35.**

Each

Hours open 10:00 am to 4:00 pm Eastern time

Minimum order 5 units 55.00 ea.

Dealers wanted. We ship COD.

King Wholesale

1-800-729-0036

Fax number 6173400053

"No one beats the King's prices!"

# DESCRAMBLERS

Try the

**Radio Electronics**

bulletin board  
system

(RE-BBS)

516-293-2283

The more you use it the more useful it becomes.

We support 300 and 1200 baud operation.

Parameters: 8N1 (8 data bits, no parity, 1 stop bit) or 7E1 (7 data bits, even parity, 1 stop bit).

Add yourself to our user files to increase your access.

Communicate with other R-E readers.

Leave your comments on R-E with the SYSOP.

RE-BBS

516-293-2283

VCR technicians. Tech tip to remove any Fisher idler wheel quick. \$5.00. **BERGE SYSTEMS**, PO Box 95, Buffalo, NY 14205.

PREVENT burglaries! Practical home security guide. Topics from burglar techniques to alarm installation. Free details! **MIDNIGHT RESEARCH**, 4129 NW 88th Avenue, Suite 282, Sunrise, FL 33351.

CABLE TV brokers and distributors high volume of descramblers Jerrold SB-3 refurbished or as is, converters Jerrold models DRX-400, JRX and hand remote control (no Canada sales for descramblers). Affitech, ask **DANIEL PERREAULT** (514) 656-9510.

KITS, MC68701 programmer \$135.00, morse code keyboard \$75.00, ten meter FM conversion \$25.00. **SINGLE CHIP SOLUTIONS**, Box 680, New Hartford, CT 06057-0680.

## CABLE DESCRAMBLERS OAK M35B COMBO \$39.95

Jerrold, Zenith, Hamlin, Sci. Atlanta, Pioneer & MORE! OUR PRICES ARE BELOW WHOLESALE!

**CABLE+PLUS**

14417 Chase St. #481-A Panorama City, CA 91402

1-800-822-9955 • Other Info. 1-818-785-4500

NO CALIF. SALES — DEALERS WANTED

DESCRAMBLER specials, RTC-56 combo \$150.00, M-35-B combo \$39.00, Tocom 5503A combo \$200.00, 5501 descrambler \$115.00, Jerrold 400 combo \$125.00, Hamlin CRX-6600 combo \$125.00, Zenith Z-Tac \$225.00, Tri-Bi super fast \$79.00, SA-3-B \$79.00, Information (702) 647-3799, orders only 1 (800) 622-3799 S.A.C..



\*\*\*\*\*PRESENTING\*\*\*\*\*  
**CABLE TV  
 DESCRAMBLERS**  
 \*\*\*\*\*STARRING\*\*\*\*\*  
**JERROLD, HAMLIN, OAK**  
 AND OTHER FAMOUS MANUFACTURERS

- FINEST WARRANTY PROGRAM AVAILABLE
- LOWEST RETAIL/WHOLESALE PRICES IN U.S.
- ORDERS SHIPPED FROM STOCK WITHIN 24 HOURS

FOR FREE CATALOG ONLY 1-800-345-8927  
 FOR ALL INFORMATION 1-818-709-9937

**PACIFIC CABLE CO., INC.**  
 7325 1/2 Reseda Blvd., Dept. 1000  
 Reseda, CA 91335



**SCANNER** buffs, national and international frequency listings with allocations. Send \$11.00 U.S. for booklet to: **BOX 1051**, Station C, Kitchener, Ontario, N2G 4G1 Canada.

**ARTWORK** created for use in printed circuit board production from your engineering schematics. Professional quality hardcopy, gerberfile, or photoplotter outputs. Reasonable rates. Send for details to: **JTD ENGINEERING**, 10628 Grandview Place, Alta Loma, CA 91701.

**SURPLUS** educational equipment, shortwave receivers adjustable 50 to 70 MGHZ, 6 meter, with private line. Information **ELECTRO TECH SCHOOLS**, 120-N. Mechanic Avenue, Alliance, OH 44601.

### INVENTORS

**INVENTORS!** Can you patent and profit from your idea? Call **AMERICAN INVENTORS CORPORATION** for free information. Over a decade of service 1 (800) 338-5656. In Massachusetts or Canada call (413) 568-3753.

### SATELLITE TV

**VIDEOCIPHER II** manuals. **Volume 1** - Hardware, **Volume 2** - Software - either \$34.95. **Volume 3** - Projects/Software, **Volume 5** - Documentation or **Volume 6** - Experimentation \$44.95 each. **Volume 4** - Repair \$99.95. **Cable Hacker's Bible** - \$34.95. **Clone Hacker's Bible** - \$34.95. Catalog - \$3.00. COD's (602) 782-2316. **TELECODE**, PO Box 6426-RE, Yuma, AZ 85366-6426.

**FREE catalog** - Lowest prices worldwide, save 40 - 60%. Systems, upgrades, parts, all major brands factory fresh and warrantied. **SKYVISION**, 2009 Collegeway, Fergus Falls, MN 56537. 1 (800) 334-6455.

**CABLE TV secrets** - the outlaw publication the cable companies tried to ban. HBO, Movie Channel, Showtime, descramblers, converters, etc. Suppliers list included. \$9.95. **CABLE FACTS**, Box 711-R, Pataskala, OH 43062.

## Cable TV Descramblers

If you find a better deal,  
 we'll better our deal.

*\*Jerrold \*Tocom \*Hamlin \*Oak  
 \*Scientific Atlanta \*Zenith*

Ask about our extended warranty program.

COD, Visa, M/C welcome.  
 Free Call - Free Catalog.

Video Tech **800-562-6884**

3702 S. Virginia St., Ste. 160-304  
 Reno, NV 89502.



INCREDIBLE MONITOR BUY!  
 THEY WON'T LAST LONG AT THESE PRICES!  
**9" TTL (Open Frame) Monitors**



\*12 Volt  
 \*Green Screen  
 \*Adjustable Brightness  
 #17198  
 New  
**\$17.99**  
 \$3.00 S/H

Also Available  
 12", (Open Frame) TTL 12V  
 Green Screen #6811 **\$19.99**

### FREE CATALOG

Included with your order. Call  
 1-800-776-3700 or send order to:

**AMERICAN DESIGN COMPONENTS**

Dept. 214-120 815 Fairview Avenue PO Box 220  
 Fairview, NJ 07022 Free catalogue without purchase  
 simply write ADC or call catalogue department 201-941-5000



**VIDEOCIPHER II descrambling manual.** Schematics, video and audio. Explains DES, EPROM, CloneMaster, 3Musketeer, Pay-per-view (HBO, Cinemax, Showtime, adult, etc.) \$16.95, \$2.00 postage. Collection of software to copy and alter EPROM codes, \$25.00. **CABLETRONICS**, Box 30502R, Bethesda, MD 20824.

### BUSINESS OPPORTUNITIES

**EASY work!** Excellent pay! Assemble products at home. Call for information. (504) 641-8003 Ext. 5192.

**MAKE \$50/hr** working evenings or weekends in your own electronics business. Send for free facts. **INDUSTRY**, Box 531, Bronx, NY 10461-0208.

**YOUR own radio station!** AM, FM, TV, cable. Licensed/unlicensed. **BROADCASTING**, Box 130-F12, Paradise, CA 95967.

**INVENTORS:** We submit ideas to industry. Find out what we can do for you. 1 (800) 288-IDEA.

# MARK V ELECTRONICS, INC.

Competitive Pricing \* Fast Shipping Since 1985

ORDER IN CALIFORNIA 800-521-MARK  
 ORDER OUTSIDE CA 800-423-3483  
 FREE CATALOG & INFORMATION (213)888-8988  
 FAX (213) 888-6868

▲ indicates the level of difficulty in the assembling of our Products. ▲ Beginner ▲▲ Intermediate ▲▲▲ Advanced ★ Assembled

MODEL	DESCRIPTION	KIT	ASSMB.
TA-120 MK2	Digital Voice Memo ▲▲▲	\$ 30.00	
TA-50A/B	Multi-Purpose Melody Generator ▲	12.84	\$ 17.20
TA-50C	Multi-Purpose Melody Generator ▲	13.65	18.71
TA-120MK2	35W Class "A" Main Power Mono Amp ▲▲	28.50	39.80
TA-300	30W Multi-Purpose Single Channel Amp ▲	20.00	29.00
TA-302	60W Stereo Power Booster (w/case) ▲▲		70.00
TA-323A	30Wx2 Stereo Pre-main Amp ▲	29.50	38.35
TA-377A	Hi-Quality FET Stereo Pre-Amp ▲▲▲	59.95	75.00
TA-400	40W Solid State Mono Amp ▲	28.00	34.93
TA-477	120W Mosfet Power Mono Amp ▲▲	68.00	85.00
TA-800	80W+80W DC Pre-Main & Power Amp ▲▲	60.92	79.20
TA-802	80W+80W DC Stereo Main Power Amp ▲▲	45.94	59.72
TA-820A	60W+60W OCL DC Pre-Main Stereo Amp ▲▲	40.39	49.37
TA-1000A	100W Dynamic Class "A" Main Power Mono Amp ▲▲	59.69	80.58
TA-1500	100Wx2 Class "A" DC Stereo Pre-Main Amp ▲▲▲	73.70	95.81
TA-2200	FET Super class "A" DC Pre-Amp ▲▲▲▲	58.24	47.70
TA-2400A	Electronic Echo & Reverb/Reverb Amp ▲▲▲▲		96.00
TA-2500	HQ Pre-Amp w/10 band graphic equalizer ★		68.80
TA-2800	Hi-FET IC Pre-Amp. w/3 way tone control ▲▲	48.90	63.57
TA-3000	Stereo Simulator (mono TV / any mono source) ▲▲	27.00	38.50
TA-3600	300W HQ Hi-Fi Power Mono Amp ▲▲▲	79.00	103.00

MODEL	DESCRIPTION	KIT	ASSMB.
TR-100A	O-15V 2A Regulated DC Power Supply (w/case) ▲▲▲	\$ 14.55	\$ 69.50
TR-355A	O-15V 5A Regulated DC Power Supply ▲	14.55	20.76
TR-355B	O-30V 3A Regulated DC Power Supply ▲	14.55	20.76
TR-503	O-50V 3A Regulated DC Power Supply ▲▲	15.75	22.65

MODEL	DESCRIPTION	KIT	ASSMB.
SM-43	3 1/2" Multi-Functional Led D.P.M. (w/ABS plastic case) ▲▲	\$ 34.50	\$ 43.00
SM-48	4 1/2" Hi-Precision D.P.M. ▲▲▲	38.00	48.00
SM-48A	4 1/2" Hi-Precision D.P.M. (w/ABS plastic case) ▲▲▲	41.20	52.00
SM-49	3 1/2" Multi-Functional LCD D.P.M. (w/hold function) ▲▲	36.00	44.50
SM-100	150 MC Digital Frequency Counter ▲▲▲	79.00	90.00
FC-1000A	1 GHz Frequency Counter ★		179.00

MODEL	DESCRIPTION	PRICE
SM-333	3 Channel Color Light Controller ▲▲▲★	\$ 51.20 \$ 65.00
TY-23B	Stereo Loudspeaker Protector ▲	13.85 19.85
TY-25	FM Wireless Microphone	10.22
TY-36	AC/DC Quartz Digital Clock ▲	19.00 26.20
TY-38	Sound/Touch Control Switch ▲	12.00 20.00
TY-41MKV	Bar/Dot Level Meter ▲▲	24.15 35.00
TY-43	3 1/2" Digital Panel Meter ▲	29.00 38.00
TY-45	20 Steps Bar/Dot Audio Level Display ▲▲	38.45 46.14
TY-47	Superior Electronic Roulette ▲▲	19.46 27.24
SM-222	7 Band HI-FI Graphic Equalizer ▲▲▲	26.80 38.80
SM-328	4 Channel Professional Color Light Controller★	
SM-328	Audio/Video Surround Sound Processor ▲▲▲▲	62.00 70.00
SM-666	Dynamic Noise Reduction ▲	26.00 34.00

MODEL	H" x W" x D"	MATCHING	PRICE
LG-1273	3" 12" 7"	TA-2800, TA-377A, TA-2200	\$ 22.16
LG-1684	4" 16" 8"	TA-323A, TA-377A, TA-2200	26.64
LG-1924	4" 19" 11 1/2"	TA-802, TA-820A, TA-1500, TA-120MK 2, TA-800, TA-1000A	32.00
LG-1925	5" 19" 11 1/2"	TA-477, TA-800, TA-1500, TA-1000A, TA-3600	35.00
LG-1983	2 1/4" 19" 8"	TA-377A, TA-2800, TA-2200, TA-120MK 2	28.50

MODEL	DESCRIPTION	MATCHING	PRICE
#001	28V x 2 6A to 30V x 2 6A	TA-800, TA-802, TA-820A, TA-1000A, TA-1500	\$ 26.00
#002	36V x 2 3A	TR-503, TA-323A, TA-400, TA-300	21.00
#003	40V x 2 6A	TA-477	27.00
#004	24V x 2 6A	TA-120 MK 2	21.00
#005	26V x 2 3A	TR-355B	15.00
#006	18V x 2 5A	TR-355A	14.50
#007	53V x 2 8A	TA-3600	42.00

\* Free gift for any purchase during Christmas Season.

**MISCELLANEOUS**

**METAL CABINETS WITH ALUMINUM PANEL**

**POWER TRANSFORMERS**

We accept major Credit Cards. Money Orders. Check and C.O.D. Orders. C.O.D. fee is \$5.00. Minimum order is \$20.00. \* We ship by UPS ground inside US (min. \$3.00) and ship by US mail outside US. Please call our sales department for orders over 2 lbs. or foreign orders. \* All assembled units have a 30 days warranty. \* Quality or Volume discount available upon request. \* Residents of CA please add sales tax 6.75%. \* All merchandise are subject to prior sale. Prices are subject to change without prior notice. We are not responsible for typographical errors.

**MARK V ELECTRONICS, INC. - 8019 E. Slauson Ave, Montebello, CA 90640**

Business & Showroom hours: (Pacific Time)  
 Mon. thru Fri. 9:30 am to 5:00 pm  
 Sat. 10:00 am to 5:00 pm

CIRCLE 93 ON FREE INFORMATION CARD



## THE ELECTRONIC GOLDMINE



The Electronic Goldmine has one of the greatest selections of unique electronic kits available in the world! We have over 130 kits and over 1,400 unique, bargain priced, components in our catalog!

**FREE CATALOG**  
With OVER 1400 DIFFERENT ITEMS INCLUDING 135 KITS! REQUEST YOUR COPY TODAY!

**Special Item**

### MINI GEIGER COUNTER KIT

- \* Detects ALL Types of Radiation
- \* Uses Sensitive Alpha Window Tubes
- \* Operates from 9V Battery (not Incl.)
- \* Comes with PC Board, Parts, Tube and Instructions
- \* Size of PC Board: 3" x 1.9"



C6430 \$59.95

### 4KV TRIGGER COIL

Use with any strobe tube that needs a 3 lead 4KV trigger.

N1700 \$1.25 EA.  
100 for \$80.00

### INVERTER TRANSFORMER

Small 4 lead transformer for use with 555 IC to convert 120VDC to 250V for strobe/fluorescent tubes with schematic.

N1703 \$2.00 EA.  
1,000 for \$1,500

### CDS CELL ASSORTMENT

Great for hundreds of projects and experiments. These change their resistance with light. 5 different types.

G764 5 for \$2.00

### GIANT HORSESHOE XENON STROBE TUBE

Largest Horseshoe Tube we have ever seen! Make a behemoth strobe to frighten everyone on Halloween, or use it in a whipper of a disco strobe! Size: 2" tall x 1-1/8" wide, glass tubing dia. 5/16". Operates on 300VDC and can be used with our 4KV trigger transformer. (stock #1700 to left).



G762 \$7.00 EACH

### RARE EARTH MAGNET

Many times stronger than other magnets, these are among the world's strongest commercially available magnets for this size. Small size only about 1.63" x .56" x .44" yet can lift up to 10 lbs. Try to remove this magnet from a steel plate, and you'll find that unless you slide it, you can't get it off! Great for thousands of experiments and applications. Normally these sell for over \$60 each, but these are surplus and have a few chips (does not effect performance). G765 \$9.00



MINIMUM ORDER: \$10.00 plus \$3.00 shipping and handling. We accept MC, Visa and Money Orders.  
SEND ORDERS TO: The Electronic Goldmine  
P.O. Box 5408 Scottsdale, AZ 85261  
PHONE ORDERS: (602) 451-7454

CIRCLE 177 ON FREE INFORMATION CARD

## CONSOLIDATED ELECTRONICS



### VOLUME I - TEST EQUIPMENT

CONSUMER & INDUSTRIAL ELECTRONICS - 18TH EDITION  
\$5.00

### "Volume I-Test Equipment"

112 pages packed with specifications on the most popular test equipment like B&K, Beckman, ARI, Simpson, Mercer, Soar, Goldstar and Vector/Viz. Choose from hundreds of multimeters, oscilloscopes, frequency counters, function generators, power supplies & more. Send \$5.00 check or money order, or call 1-800-543-3568 today & use your Mastercard or Visa. Consolidated Electronics, Incorporated  
705 Watervliet Avenue., Dayton, Ohio 45420-2599

NAME \_\_\_\_\_  
ADDRESS \_\_\_\_\_  
CITY \_\_\_\_\_ STATE \_\_\_\_\_ ZIP \_\_\_\_\_

CIRCLE 70 ON FREE INFORMATION CARD

## MIKE NELSON'S MOVIE VIEW SALES

CABLE T.V. CONVERTERS  
DESCRAMBLERS REMOTES  
(No Illinois Sales)

- JERROLD  OAK  
 SCIENTIFIC  HAMLIN  
ATLANTA  6 MOS.  
 LOW PRICES  WARRANTY

MIKE HAS 10 YRS. EXPERIENCE  
IN THE CABLE BUSINESS.

CALL 708-766-5222  
OR MOVIE VIEW SALES  
WRITE P.O. BOX 26  
WOOD DALE, IL 60191

LET the government finance your small business. Grants/loans to \$500,000. Free recorded message: (707) 449-8600. (KS1).

CIRCUIT board design services: development, schematic and PCB layouts. Quick turnaround. (503) 345-4609. SKYCHASER, 980 Sherwood Place, Eugene, OR 97401.

MAKE \$75,000 to \$250,000 yearly or more fixing IBM color monitors (and most brands). No investment. Start doing it from your home. (A telephone required.) Information, USA, Canada \$1.00 cash. US funds. other countries \$8.00 RANDALL DISPLAY, Box 2168-R, Van Nuys, CA 91404 USA.

VIDEO magic. Start your own business. Video security system. No wiring required. Ideal for small businesses, homes, property, marina. \$950.00 gets you started. Camera only \$490.00. Call: VIDEO MAGIC (516) 249-4216.

## K.D. VIDEO

FOR ALL YOUR CABLE TV NEEDS  
WE SPECIALIZE IN DEALER PRICING

QTY	1	10	20
Jerrold (Type) SB-3	89.00	56.00	48.00
Jerrold (Type) Tri-Bi	119.00	69.00	65.00
Scientific Atlanta SA-3	129.00	80.00	75.00
Hamlin MLD-1200	99.00	59.00	45.00
Oak N-12 Vari-Sync	99.00	59.00	58.00
Jerrold 550 Converter	99.00	75.00	68.00
Jerrold 400 DRX-3DIC (With Built in SB-3)	169.00	109.00	100.00

1-800-327-3407

Call us for prices on large quantities

K.D. Video PO Box 29538, Mpls., MN 55429

### PLANS AND KITS

MINIATURE FM transmitters! Tracking transmitters! Voice disguisers! Bug detectors! Phone Devices! More! Available in kits or assembled! Catalog \$2.00: XANDI ELECTRONICS, Box 25647, Dept. 60L, Tempe, AZ 85285-5647.

CATALOG: hobby/broadcasting/HAM/CB: Cable TV, transmitters, amplifiers, surveillance devices, computers, more! PANAXIS, Box 130-F12, Paradise, CA 95967.

### REMOTE CONTROL KEYCHAIN



Complete w/mini-transmitter and +5 vdc RF receiver. Fully assembled including plans to build your own auto alarm. Quantity discounts available.

\$24.95 Check, Visa or M/C Add \$3 shipping

VISITECT INC. BOX 5442, SO. SAN FRAN., CA. 94080  
(415) 872-0128 Fax (415) 872-2635

INVESTIGATORS, experimenters — Quality new plans. Micro and restricted devices. Free catalog. Self addressed stamped envelope required KELLEY SECURITY INC., Suite 90, 2531 Sawtelle Blvd., Los Angeles, CA 90064.

SURVEILLANCE transmitter kits! Four models of each; telephone, room, combination telephone/room transmitters tune from 65 to 305 MHz. Catalog with Popular Communications and Popular Electronics book reviews of "Electronic Eavesdropping Equipment Design," \$1.00. SHEFFIELD ELECTRONICS, 7223 Stony Island Ave., Chicago, IL 60649-2806.

CB Tricks II book. Power amplifier design and theory. UHF CB tune ups. Send \$19.95 MEDICINE MAN CB, PO Box 37, Clarksville, AR 72830.

KITS — alarms, games, and test equipment. Send \$1.00 for catalog. RAKJAB, PO Box 1875, Apopka, FL 32704.

### LASERS



New Laser Diodes \$15

Helium-Neon Laser Tubes from \$25



New Visible Diode Modules

FREE CATALOG CALL OR WRITE TODAY!

COMPLETE HELIUM-NEON LASERS FROM \$110.00

MEREDITH INSTRUMENTS PO. Box 1724/Glendale, AZ 85311/(602)934-9387

PC/TV Interface — RGB to TV/video/VCR. Switchable between PC and composite video inputs. Channels 3 or 4. RF output. Complete PC card kits \$59.95. PC board only \$19.95. Mass. residents add 5% sales tax. INOVONICS CORP. 9 Bartlett St., Dept. 36, Andover, MA 01810.

DESCRAMBLING, new secret manual. Build your own descramblers for cable and subscription TV. Instructions, schematics for SSAVI, Gated Sync, Sinewave, (HBO, Cinemax, Showtime, UHF, adult) \$12.95, \$2.00 postage. CABLETRONICS, Box 30502R, Bethesda, MD 20824.

LASER lighting entertainment systems. Create your own 3-dimensional laser light shows with these professional secrets! Detailed mechanical and electrical schematics, designs for any budget! \$20.00. MILLENNIUM, 229 McAfee, Thousand Oaks, CA 91360.

## COMPUTER KITS

General Technics  
Quality Computer Systems  
Post Office Box 2676  
Lake Ronkonkoma, NY 11779  
(516) 981-9473



General Technics Computer Kits include a complete line of 8088, 286, and 386 models. They are designed to offer the highest degree of quality and reliability available today. They're also fun, easy to build, educational, fully IBM compatible, very powerful, and at wholesale prices. All kits are pre-tested and include a free step by step assembly manual, software, one year warranty and our 24 hour support/order phone line. Assembly is available.

ask for your free catalog

CAR alarm schematic with instructions, easy construction and installation. \$6.00: HUNTER, 1802 Cook, Duncan, OK 73536.

DAZER II personal protection device! Plans \$8.00. Lasers! Transmitters! Detectors! More! Kits or assembled! Catalog \$2.00. QUANTUM RESEARCH, 16645-113 Avenue, Edmonton, Alberta T5M 2X2.

PEN transmitter: Sensitive micro FM transmitter, housed inside standard size pen. Latest surface mount technology. Complete kit and instruction \$42.95. MIERONIC-INT., Box 5726, Sherman Oaks, CA 91413.

BUILD this Pseudo car alarm-Led flasher with automatic disable via the ignition switch. Detailed schematic with educational information \$2.50. LMT ELECTRONICS, Box 4268, Diamond Bar, CA 91765.

UNIQUE projects. Build an infrared motion detector, ultrasonic distance meter, digital rain gauge. Complete plans, PCB layout. \$4.00 each. Others available. K. KEMP, 13772 Goldenwest St., #549, Westminster, CA 92683.



## ANTIQUE RADIO CLASSIFIED

Free Sample!

Antique Radio's  
Largest Circulation Monthly.  
Articles, Ads & Classifieds.



6-Month Trial: \$13. 1-Yr: \$24 (\$36-1st Class).  
A.R.C., P.O. Box 802-L6, Carlisle, MA 01741

**METAL** project boxes - 50% off! Huge selection. Plus storage capacitors, amplifier kits, electronic parts. Free catalog. **SCC**, Box 551RE, Dublin, OH 43017.

**AUDIO circuits** - Highend designer's private files - PA, Hi-Fi, digital, studio broadcast, - free catalog - **ETA INC.**, Box 829, Shingle Springs, CA 95682.

**PCB** and schematic CAD software. Easy multilayer rubberband zoom pan and more. CGA EGA IBM compatibles. \$195.00. **NUMBER ONE SYSTEMS**, 10565 Bluebird Street, Coon Rapids, MN 55433.

### Pay TV and Satellite Descrambling NEW \*\*\* 1991 EDITION \*\*\* NEW

All new information. Turn-ons, bypasses, build your own. Our best yet. \$15.95. Wireless Cable Handbook \$9.95, Build Satellite Systems Under \$600 \$12.95. Experiments with Videocipher \$12.95. The P.T.V. and S.D. series Volume I (basics) \$14.95, V.89 \$14.95, Any 3/329 or 6/342. Scrambling News Monthly \$19.95. Sample \$3. This month "Turning on Jerrold". New Winter catalog \$1 or call (anytime). COD's are OK. 716-874-2088.

Scrambling News, 1552 Hertel Ave.,  
Buffalo, NY, 14216. (716) 874-2088

**REMOTE control.** 20 page package gives info and schematics on encoder/decoder circuitry. \$5.00. **CONTINUOUS CONCEPTS**, PO Box 60414, San Diego, CA 92166. CA residence add 7.25% tax.

**PLANS!** Vehicle alarm battery backup system. Schematic, artwork, instructions. \$10.95. **AGK ELECTRONICS**, N.K. PO Box 28123, Winnipeg, Manitoba R2G 4E9.

**POWERFUL** single-chip FM room transmitter, size of a postage stamp, transmits to any FM radio up to one mile away. Complete kit \$19.95 postpaid. **HERTZ MICRODEVICES**, Box 41771, LA, CA 90041.

## EDUCATION & INSTRUCTION

**MAGIC!** Four illustrated lessons plus inside information shows you how. We provide almost 50 tricks including equipment for four professional effects. You get a binder to keep the materials in, and a one-year membership in the International Performing Magicians with a plastic membership card that has your name gold-embossed. You get a one-year subscription to our quarterly newsletter "IT's MAGIC!" Order now! \$29.95 for each course + \$3.50 postage and handling. (New York residents add applicable state and local sales tax). **THE MAGIC COURSE**, 500-B BiCounty Boulevard, Farmingdale, NY 11735.

**F.C.C. Commercial General Radiotelephone license.** Electronics home study. Fast, inexpensive! "Free" details. **COMMAND**, D-176, Box 2824, San Francisco, CA 94126.

**LEARN IBM PC assembly language.** 80 programs. Disk \$5.00. Book \$18.00. **ZIPFAST**, Box 12238, Lexington, KY 40581-2238.

**CONSUMER** advocate. Help sources, any problem. SASE for description. **HELP**, Box 132, Indian Rocks, FL 34635.

## CABLE TV DESCRAMBLER LIQUIDATION!

FREE CATALOG!

Hamlin Combos \$44, Oak M35B \$60 (min. 5), etc.

**WEST COAST ELECTRONICS**

For Information: 818-709-1758

Catalogs & Orders: 800-628-9656

## CABLE TV EQUIPMENT

Converters, Remote Controls,  
Descramblers, CD Players.

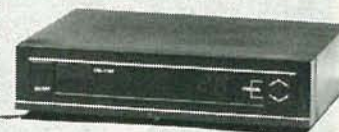

**JERROLD-OAK-SCIENTIFIC ATLANTA-HAMLIN  
ZENITH** MANY MORE CALL TODAY!

✓ Only quality products sold ✓ Easy to use  
✓ Satisfaction guaranteed ✓ Knowledgeable sales staff  
✓ Most orders shipped within 24 hours

CALL FOR YOUR FREE CATALOG

**MC** 1-800-228-7404 **VISA**

MAKE THE CONNECTION

WITH

**NU-TEK ELECTRONICS**

5114 Balcones Wood Dr.#307 Dept.298

Austin, TX. 78759

## CABLE BOX REPAIR

**JERROLD** 400 opportunity CATV repair manual. DRX-3DIC-105 cable converter. CAD drawings. Circuit schematics, microprocessor pinout... parts list, parts available \$14.95 + \$2.00 P&H. Rush US PO money order, cash or check to **BONDED CABLE T.V. CO.** \* No COD.

**MASTERCARD AND VISA** are now accepted for payment of your advertising. Simply complete the form on the first page of the Market Center and we will bill.



### 2-1/2" SANYO TWEETER

Paper cone with gold tone dust cap. 8 oz. magnet. 8 ohm. 1/2" ferro fluid voice coil. Power handling: 50W RMS, 70W max. Frequency response: 3K-20KHz.



#RP-271-020 \$1<sup>95</sup> \$1<sup>75</sup> 95c

(1-9) (10-59) (60-up)

### SUPER HORN TWEETER

Original piezo tweeter made by Motorola. SPL=94 dB 2.83V/1M. Response: 4KHz-27KHz. Handles approximately 50 watts.



#RP-270-010 \$5<sup>30</sup> \$4<sup>50</sup> \$3<sup>95</sup>

(1-9) (10-79) (80-up)

### 2" DOME MIDRANGE

Textile dome midrange made by Philips. 8 ohm. SPL=90 dB 1W/1M. 30W RMS, 40W max. Response: 550-5KHz.



#RP-280-210 \$27<sup>90</sup> \$25<sup>70</sup>

(1-3) (4-up)

### 15" SUBWOOFER



Dual voice coil. 40 oz. magnet. 6 ohm imp. 100W RMS, 140W max. Response: 20-1.2KHz. Resonant frequency: 21Hz. SPL=93 dB 1W/1M.

#RP-290-190 \$54<sup>50</sup> \$49<sup>80</sup>

(1-3) (4-up)

### SUBWOOFER XOVER



200W RMS crossover designed specifically for use with dual voice coil subwoofers. 12 dB per octave roll-off at 150Hz.

#RP-260-220 \$28<sup>80</sup> \$24<sup>40</sup>

### 10" POLY WOOFER

Medium duty. 60W RMS, 80W max. 14 oz. magnet. Response: 25-2.5KHz. fs=28Hz.



#RP-290-096 \$18<sup>50</sup> \$16<sup>90</sup>

(1-3) (4-up)

### TITANIUM COMPOSITE TWEETER

The advantages of both hard and soft dome technologies. 8 ohm. Ferro fluid cooled voice coil. SPL=90 dB 1W/1M 50W RMS, 70W max. 4" round. Polydax #DTW100T125.



#RP-270-047 \$27<sup>50</sup> \$24<sup>80</sup>

(1-9) (10-up)

### SPEAKER BUILDING BOOK

Revised edition of David Weems' best selling book. Learn to build low cost speakers that rival the high priced models.



#RP-500-021 \$16<sup>95</sup>

### 12" CAST FRAME WOOFER



12" woofer made in the USA by Eminence. Paper cone and dust cap with treated cloth surround. 80 oz. magnet. 2-1/2" vented voice coil. 8 ohm. 170W RMS, 235W max. 40-4.5KHz response.

#RP-290-147 \$72<sup>90</sup> \$69<sup>50</sup>

(1-3) (4-up)



FREE CATALOG

**Parts Express**  
340 E. First St., Dayton, Ohio 45402  
Local: 1-513-222-0173  
FAX: 513-222-4644

• 15 day money back guarantee • \$15.00 minimum order • We accept Mastercard, Visa, Discover, and C.O.D. orders. • 24 hour shipping • Shipping charge = UPS chart rate + \$1.00 (\$3.00 minimum charge) • Hours 8:30 am- 7:00 pm EST, Monday - Friday • Mail order customers, please call for shipping estimate on orders exceeding 5 lbs. Foreign customers please send \$5.00 U.S. funds for catalog postage.

CALL TOLL FREE  
1-800-338-0531

CIRCLE 56 ON FREE INFORMATION CARD

DECEMBER 1990

95



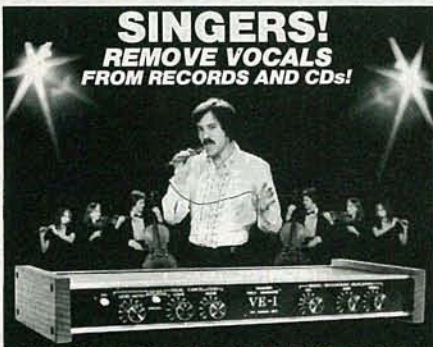

**SINGERS!**  
**REMOVE VOCALS**  
**FROM RECORDS AND CDS!**

**SING WITH THE WORLD'S BEST BANDS!**  
 An Unlimited supply of Backgrounds from standard stereo records! Record with your voice or perform live with the backgrounds. Used in Professional Performance yet connects easily to a home component stereo. This unique product is manufactured and sold Exclusively by LT Sound - Not sold through dealers. Call or write for a Free Brochure and Demo Record.

**LT Sound**, Dept. RL-3, 7980 LT Parkway  
 Lithonia, GA 30058 (404) 482-4724  
 Manufactured and Sold Exclusively by LT Sound  
**24 HOUR PHONE DEMO LINE: (404) 482-2485**

**ZENITHS & TOCOMS**

**SUPER Zenith (Z-TAC) converters (flashing)...** \$169.00. Zenith "turn-on" module... \$49.00.  
**Tocom 5503(A) & 5504 converters...** \$139.00.  
**Tocom (add-on) descramblers...** \$79.00. **Tocom (5503-VIP & 5507) "turn-on" chips...** \$49.00. **CIN-EPLEX VIDEO GROUP. 1 (800) 726-4627.**

**WANTED**

**INVENTORS!** Confused? Need help? Call **IMPAC** for free information package. US/Canada: 1 (800) 225-5800 (24 hours!).

**FREE CATALOG!**  
**1-800-648-7938**  
 For all information 1-702-362-9026  
**JERROLD HAMLIN OAK ETC.**  
**CABLE TV**  
**DESCRAMBLERS**  
 • Compare our low Low Retail Prices!  
 • Guaranteed Prices & Warranties!  
 • Orders Shipped Immediately!  
**REPUBLIC CABLE PRODUCTS INC.**  
 4080 Paradise Rd. #15 Dept. RE-90  
 Las Vegas, NV 89109

**INVENTIONS/new products/ideas wanted:** call **TLCI** for free information 1 (800) 468-7200 24 hours/day - USA/Canada.

**BEST BY MAIL**  
 Rates: Box 5, Sarasota, FL 34230  
**BOOKS/CATALOGS/MAGAZINES**  
 50,000 + CATALOG LISTINGS! \$5.95: Catalogs, Box 92452GT, Atlanta, GA 30314.  
**MONEYMAKING OPPORTUNITIES**  
 "SECRETS OF THE Millionaires." Free Details. Milligan, 204(RE) Kildeer, Buda, TX 78610.  
**\$330 + WEEKLY ASSEMBLING** products from home. Guaranteed! Amazing recorded message! 24 hours. (316)292-2091, Extension 132.  
**MAKE \$100.00 DAILY** selling money-making information and wholesale merchandise. Act Now! Free details. Write: Box 492-C, So. Orange, NJ 07079.

**COMPUTER BOOKS**  
**DISCOUNT computer books!** Thousands of titles available. Including recent releases. Please call or write for our latest free catalog. **BOOKWARE**, 344 Watertown Road, Thomaston, CT 06787. 1 (800) 288-5662, (203) 283-6973.

**THIS A REGULAR TYPE BOLDFACE AD with a tint screen. To have your ad appear like this one, the cost is \$4.15 per word.**



After you give something to your friends and family, may we suggest about 23 million other people?

When you support the Christmas Seal Campaign® you're benefitting research and programs that give over 23 million Americans with chronic lung disease the one thing they want this Christmas. Hope.

**AMERICAN LUNG ASSOCIATION**  
 The Christmas Seal People®

**BUY BONDS**

**UNICORN - YOUR I.C. SOURCE!**

**COLLIMATOR PEN (INFRA-RED)**



- Output: 2.5 mW (max.)
- Current: 90-150 mA
- Operating Voltage: 2.2-2.5V
- Wavelength: 820nm
- Collimation: .18mrad (typ.)
- Size: 11mm diameter

**STOCK # SB1052 PRICE \$39.99**

**LASER DIODE (INFRA-RED)**

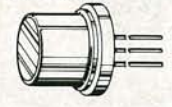

- Output: 10 mW (max.)
- Current: 90-150 mA
- Operating Voltage: 2.2-2.5V
- Wavelength: 820nm

**STOCK # SB1053 PRICE \$9.99**

**LASER DIODE (VISIBLE-RED)**

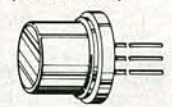

- Output: 5 mW (max.)
- Current: 65-100 mA
- Operating Voltage: 1.75-2.2V
- Wavelength: 780nm

**STOCK # LS022 PRICE \$19.99**

**LASER DIODE (VISIBLE-RED)**

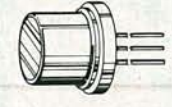

- Output: 4 mW (max.)
- Current: 20 mA
- Operating Voltage: 2.2-3.0V
- Wavelength: 665nm

**STOCK # LS3200 PRICE \$129.99**

**POWER SUPPLY**



- Input: 115/230v
- Size 7" L x 5 1/4" W x 2 1/2" H
- Output: +5 volts @ 3.75 amps
- Output: +12 volts @ 1.5 amps
- Output: -12 volts @ .4 amps

**STOCK # PS1003 PRICE \$19.99**

**EPROMS**

STOCK #	PINS	DESCRIPTION	1-24	25-99	100+
1702	24	256 x 4 1us	3.99	3.79	3.41
2708	24	1024 x 8 45ns	6.49	6.17	5.55
2716	24	2048 x 8 450ns (25v)	3.29	3.13	2.82
2716-1	24	2048 x 8 350ns (25v)	3.79	3.60	3.24
TMS2716	24	2048 x 8 450ns	6.29	5.98	5.38
27C16	24	2048 x 8 450ns (25v-CMOS)	3.99	3.79	3.41
2732	24	4096 x 8 450ns (25v)	3.79	3.60	3.24
2732A-2	24	4096 x 8 200ns (21v)	3.79	3.60	3.24
2732A	24	4096 x 8 250ns (21v)	3.69	3.51	3.16
2732A-4	24	4096 x 8 450ns (21v)	3.19	3.03	2.73
TMS2532	24	4096 x 8 450ns (25v)	5.79	5.50	4.95
TMS2532P	24	4096 x 8 450ns (25v-One Time Programmable)	1.99	1.89	1.70
27C32	24	4096 x 8 450ns (25v-CMOS)	4.19	3.98	3.58
2764-20	28	8192 x 8 200ns (21v)	3.99	3.79	3.41
2764	28	8192 x 8 250ns (21v)	3.79	3.60	3.24
2764A-20	28	8192 x 8 200ns (12.5v)	3.99	3.79	3.41
2764A	28	8192 x 8 250ns (12.5v)	3.29	3.13	2.82
TMS2564	28	8192 x 8 250ns (25v)	6.79	6.45	5.81
27C64	28	8192 x 8 250ns (21v-CMOS)	4.19	3.98	3.58
27128-20	28	16,384 x 8 200ns (21v)	5.79	5.50	4.95
27128	28	16,384 x 8 250ns (21v)	5.09	4.84	4.35
27128A	28	16,384 x 8 250ns (21v)	5.79	5.50	4.95
27C128	28	16,384 x 8 250ns (21v)	5.79	5.50	4.95
27256-20	28	32,728 x 8 200ns (12.5v)	5.29	5.03	4.53
27256	28	32,768 x 8 250ns (12.5v)	4.79	4.55	4.09
27C256	28	32,768 x 8 250ns (12.5v)	5.29	5.03	4.53
27512-20	28	65,536 x 8 200ns (12.5v)	7.49	7.12	6.41
27512	28	65,536 x 8 250ns (12.5v)	6.99	6.64	5.98
27C512	28	65,536 x 8 250ns (12.5v-CMOS)	6.99	6.64	5.98
27C1024	32	131,072 x 8 200ns (12.5v-CMOS)	17.99	17.09	15.38
68764	24	8192 x 8 450ns	13.99	13.29	11.96
68766	24	8192 x 8 450ns	14.99	14.24	12.82



10010 Canoga Ave., Unit B-8 • Chatsworth, CA 91311  
**OUTSIDE CALIFORNIA: (800) 824-3432 (Orders Only)**  
**IN CALIFORNIA: (818) 341-8833**  
**ORDER BY FAX: (818) 998-7975**  
 Minimum Order \$15.00



QUALITY PARTS • DISCOUNT PRICES • FAST SHIPPING

# ALL ELECTRONICS CORP.

## DIGITAL CLOCK AND APPLIANCE TIMER

Digital clock and appliance timer removed from automatic electric coffee makers due to design changes. Operates on 120 Vac and is capable of turning on appliances drawing up to 10 amps. Because of the application they were designed or they automatically turn off after two hours. Some have surface blemishes. 4.2" X 2.45" X 1.1" deep. Beige or ivory with brown trim.  
**CAT# MCT \$6.50 each**



## 12 VDC GEARHEAD MOTOR

Soho# GBL 35-DH-21080-10Y  
 Powerful little gearhead motor. 40 RPM @ 12 Vdc. 0.5 amps (no load). 32 RPM with load. Operates at lower voltages with reduced speed and torque. 6.3 pound inches torque. Stall: 27 pound inches. 3.1" long X 1.375" diameter. Shaft: 0.187" dia. X 0.75" long.  
**CAT# MOTG-14 \$11.50 each**  
**10 for \$100.00**

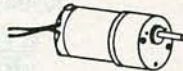

## 150 MICROAMP METERS

150 microamp full scale. 2.165" X 1.875" X 0.96" deep  
 Face is 1.965" X 1.1". White background with black and red scale.  
 Two types. One is marked "Modulation" and has a 0 - 100 scale. The other has two scales, "RF" and "SWR". Otherwise meter are identical.  
 \*Modulation\* meter **CAT# MET-21 \$3.50**  
 RF/SWR meter **CAT# MET-22 \$3.50**

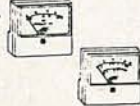

## ONE MINUTE TIMER

This white box with a blue button will drive you crazy. Box measures 3 1/4" square X 2" high. When the button is pressed 4 LEDs light and a beeper pulses. Every 15 seconds one led goes out and the speed of the beeping increases. At the end of 60 seconds the unit gives off a long beep followed by a low squelch, all LEDs shut off and the unit stops. Unit requires a 9 volt transistor battery (not included) to operate.  
**CAT# TMR-1 \$2.25 each • 10 for \$20.00**



## SWITCHES

**SPDT PUSHBUTTON**  
 Marquardt# 1843  
 Rated 6 amps @ 125/250 Vac. Black plastic pushbutton. Switch body: .92" X .94" X .65".  
**CAT# PB-18 \$1.65 ea. • 10 for \$15.00**

**PUSHBUTTON SWITCH**  
 GC/Thornsen# 35-420  
 S.P.S.T. normally open momentary pushbutton switch. Red plastic actuator 0.57" diameter. Chrome bezel 0.68" diameter. Threaded bushing mounts in .50" diameter hole. Rated 3 amp @ 250Vac. Solder loop terminals.  
**CAT# PB-20 \$1.00 each**



**THUMBWHEEL SWITCH**  
 1 pole 10 position decimal encoded switches which interlock to make up desired number or digits. Terminates to 11 pc pins (1 common and 10 poles). Each section measures .31" wide X .20" high X .78" deep. End plates can be added to form a .94" high bezel.  
**CAT# SWTH-9 \$1.25 each**  
**10 for \$10.00**

**2 END PLATES - CAT# SW-9EC \$1.00/Set**

**MINIATURE TOGGLE SWITCH**  
 Rated: 3 amps @ 120 Vac  
 S.P.S.T. (ON-ON) solder lugs  
**CAT# MTS-4 \$1.35 each**



## NICKEL-CAD BATTERIES (RECHARGEABLE)

AAA SIZE \$1.50 each  
 1.2 volts 180 mAh  
**CAT# NCB-AAA**

AA SIZE \$2.00 each  
 1.25 volts 500 mAh  
**CAT# NCB-AA**

AA SIZE \$2.20 each  
 WITH SOLDER TABS  
**CAT# NCB-SAA**

C SIZE \$4.25 each  
 1.2 volts 1200 mAh  
**CAT# NCB-C**

D SIZE \$4.50 each  
 1.2 volts 1200 mAh  
**CAT# NCB-D**

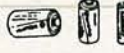

## 0 - 6 HOUR AUTO SHUT-OFF TIMER

M.H. Rhodes, Inc. Mark-Time# 90007  
 Timer fits standard 3" deep wallbox. Rated 20 amps @ 125 Vac. Turn knob to desired time. Includes hardware, beige wallplate, and knob. UL and CSA listed. **CAT# TMC-6 \$5.75 each • 10 for \$50.00**



## SPECIAL PURCHASE 210 MFD 330 V PHOTOFASH CAPACITOR

Rubicon CE photoflash capacitor. 0.79" dia. X 1.1" high. These are new capacitors that have been prepped with 1.4" black and red wire leads soldered to the terminals.  
**CAT# PPC-210 \$2.50 each**  
**10 for \$22.50 • 100 for \$200.00**  
 Large quantities available. Call for pricing.



## LED'S

**STANDARD JUMBO DIFFUSED T 1-3/4 size (5 mm)**

**RED CAT# LED-1**  
 10 for \$1.50 • 100 for \$13.00

**GREEN CAT# LED-2**  
 10 for \$2.00 • 100 for \$17.00

**YELLOW CAT# LED-3**  
 10 for \$2.00 • 100 for \$17.00

**FLASHING LED**  
 with built in flashing circuit 5 volt operation. T 1-3/4 (5mm)

**RED CAT# LED-4** 10 for \$9.50

**GREEN CAT# LED-4G** 10 for \$9.50

**YELLOW CAT# LED-4Y** 10 for \$9.50

**LED HOLDER**  
 Two piece holder.  
**CAT# HLED 10 for 65¢**

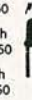

## L.E.D. FLASHER KIT

Two L.E.D.'s flash in unison when a 9 volt battery is attached. This kit includes a p.c. board, all the parts and instructions to make a simple flasher circuit. A quick and easy project for anyone with basic soldering skills.  
**CAT# LEDKIT \$1.75 per kit**



## LED CHASER KIT

Build this variable speed led chaser. 10 leds flash sequentially at whatever speed you set them for. Easy to build kit includes pc board, parts and instructions. Ideal for special lighting effects, costumes, etc. Operates on 3 to 9 volts. PC board is 5" X 2.25". A great one hour project. **CAT# AEC \$6.50 each**



## XENON TUBE

1" long flashtube with 3 1/2" red and black leads. Ideal for electronic flash or strobe projects.  
**CAT# FLT-3 2 for \$1.00**



## STEPPER MOTOR

Airpax P/N C82711-M1  
 17 Vdc dual coil, permanent magnet stepper. 23.25 ohm coil. 7.5 degrees per step.  
**CAT# SMT-6 \$6.00 each • 10 for \$50.00**



## RELAYS

**6 VOLT D.C. - S.P.D.T.**  
 Aromat # RSD-6V  
 Super small relay. Rated: 1 amp @ 30 Vdc. TTL direct drive possible. Operates on 4.3 to 14 Vdc. Coil: 220 ohms. 1 3/16" X 1 3/32" X 7/16". **CAT# RSD-6V \$1.50 each • 10 for \$13.50**



## INSTRUMENT ENCLOSURES

High quality molded ABS instrument enclosures. Integrated PC board standoffs and two sets of vertical mounting slots for front and rear sub panels. All enclosures are 6" wide X 6 1/4" deep. Choice of three hts. Includes non-skid rubber feet and hardware. Available in beige, ivory, black, and blue.

Panel ht. **CAT#**

2 1/4" **CAT# MB-A \$7.50 each** 10 for \$65.00

2 5/8" **CAT# MB-B \$7.75 each** 10 for \$67.50

3" **CAT# MB-C \$8.00 each** 10 for \$70.00

Please specify color.



## RG-11/U 75 OHM VIDEO CABLE

100 ft. or 200 ft. rolls of RG 11/U terminated to heavy duty F connectors. Includes 75 ohm terminator and F-61 splicer on one end. New cables manufactured for IBM PC networks. IBM P/N 1501908 COMSCOPE.  
**CAT# RG-11-1 100 ft. roll \$15.00**  
**CAT# RG-11-2 200 ft. roll \$27.50**



## PHOTO RESISTOR

100 ohms bright light. 16K ohms dark. 0.182" dia. X .08" high. 0.18" long leads. **CAT# PRE-7 2 for \$1.00**  
**100 for \$45.00 • 1000 for \$400.00**



## OPTO SENSOR

Standard U-shaped slotted optical switch with 1/8" gap between sides. 0.75" mounting centers.  
**CAT# OSU-7 2 for \$1.00**



## REFLECTIVE OPTO SENSORS

These units have an IR emitter and sensor pair pointing in the same direction. Light from emitter bounces off object to be detected by sensor. Effective range approx. 0.15". Three types available.

TRW/Optron # OPB5447-2  
 Rectangular w/ 28" wire leads  
**CAT# OSR-4 2 for \$1.00**



## TRW/Optron # OPB703A

Wedge shape with PC pins.  
**CAT# OSR-3 75¢ each**



## TRW/Optron # OPB711

Rectangular with PC pins.  
**CAT# OSR-2 75¢ each**



## WALL TRANSFORMERS

ALL PLUG DIRECTLY INTO 120 VAC OUTLET

6 Vac @ 600 ma. **CAT# ACTX-660 \$3.50**

8.3 Vdc @ 10 ma. **CAT# DCTX-8310 \$1.50**

12 Vdc @ 500 ma. **CAT# DCTX-125 \$4.50**



## 12 Vdc 5 AMP POWER SUPPLY

ACDC Electronics # 12N5 or equiv. Input: 100-240 Vac (wired for 115 Vac) Output: 12 Vdc @ 5 amps. Open frame power supply. 7" X 4 3/4" X 3" high. Regulated.  
**CAT# PS-125 \$37.50 each**

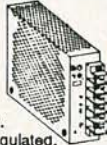

## 12 VOLT D.C. D.P.D.T. DIP RELAY

Miniature relay fits standard 16 pin (dip) sockets or will directly mount to p.c. boards. GI Clare# LM44D00 • 280 ohm • 30 va switching.  
**CAT# CRLY-12 \$2.50 each**



## 24 VOLT D.C. COIL

KUP style 11 pin base can be socketed, direct soldered or quick connect terminals can be used. 1 3/8" x 1 1/2" x 2". 3 P.D.T. • 5 amp contacts • 470 ohm  
**CAT# RLY-3524 \$2.25 each**



# ORDER TOLL FREE 1-800-826-5432

FAX (818) 781-2653 • INFORMATION (818) 904-0524

Call Or Write For Our Free 60 Page Catalog  
 Outside the U.S.A. send \$2.00 postage for a catalog.

Minimum Order \$10.00 • All Orders Can Be Charged To Visa, Mastercard Or Discovercard • California, Add Sales Tax • Shipping And Handling \$3.50 For the 48 Continental United States - All Others Including Alaska, Hawaii, P.R. And Canada Must Pay Full Shipping • Quantities Limited • No C.O.D. • Prices Subject to change without notice.



MAIL ORDERS TO: ALL ELECTRONICS CORP • P.O. BOX 567 • VAN NUYS, CA 91408

CIRCLE 107 ON FREE INFORMATION CARD

DECEMBER 1990



### GoldStar 20MHz Oscilloscope

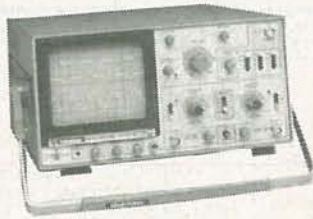

- Features:
- 6" rectangular CRT display, internal graticule & scale
  - Phase difference measurements between two forms under two methods: x-y scope and Dual Trace
  - Two different scale probes: x1 and x10
  - Bandwidth from DC to 20MHz
  - Includes: Two 40MHz probes, two fuses, power cord, operation manual, schematics and block and wiring diagram
  - High sensitivity: 1mV/div
  - Two-Year Warranty

GS7020.....\$499.95

### Jameco Universal IC Programmer

Memory Devices: EPROMS, EEPROMS and PROMS  
Logic Devices: PALs, GALs, RALs, EPLDs, EEPLDs and FPLDs

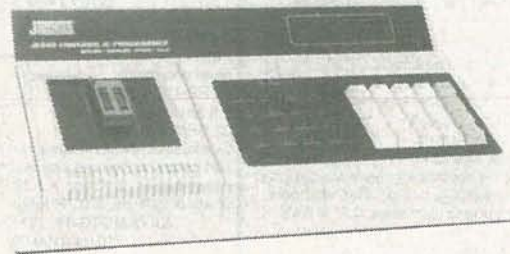

- Stand alone or computer controlled mode via RS232C port
- The JE680 uses the JEDEC standard for logic devices. Accepts input from virtually all major software packages including: PALASM, PLAN, CPUL, ABEL, and AMAZE

JE680.....\$1799.95

### Jameco Logic Pulser



- Compatible with TTL, DTL, RTL, HTL, HNIL, MOS and CMOS ICs.
- 1MΩ Sync input impedance
- "One shot" or continuous 5Hz train pulse
- Pulse repetition rate: 0.5pps/400pps.
- Pulse width output at 100ma load: 10μs
- Pulser mode output current: 10mA
- Square wave current output: 5mA
- Audible tone
- Size: 7.75"L x 1"W x .625"H.

LP540.....\$16.95

### PROTOTYPING PRODUCTS Jameco Solderless Breadboards

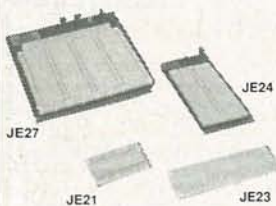

Part	Dim. L" x W"	Contact Points	Binding No. Posts	Price
JE21	3.25 x 2.125	400	0	\$4.95
JE23	6.5 x 2.125	830	0	\$6.95
JE24	6.5 x 3.125	1,360	2	\$12.95
JE25	6.5 x 4.25	1,660	3	\$17.95
JE26	6.875 x 5.75	2,390	4	\$22.95
JE27	7.25 x 7.5	3,220	4	\$32.95

### Jameco Logic Probe



- Max Frequency 80MHz • Minimum detectable pulse: 10ns • 120KΩ input impedance • Max. supply voltage: +25V • TTL threshold: (Lo) +0.6V ±0.1V (Hi) +2.3v ±0.2V • CMOS threshold: (Lo) 30% VCC +10% (Hi) 70%VCC +10%

MS104.....\$24.95

### Metex Digital Multimeters

#### General Specs:

- Handheld, high accuracy • AC/DC voltage, AC/DC current, resistance, diodes, continuity, transistor hFE
- Manual ranging w/ overload protection



- M3650 & M4650 only: • Also measure frequency and capacitance

M4650 only: • Data hold switch • 4.5 digit

M3610	3.5 Digit Multimeter	\$59.95
M3650	3.5 Digit Multimeter w/ Frequency & Capacitance	\$74.95
M4650	4.5 Digit w/Frequency, Capacitance and Data Hold Switch	\$99.95

### Handheld Multimeter



- 3.5 digit LCD with automatic polarity indication • AC/DC voltage measurement up to 500 volts • AC/DC current measurement up to 200mA • Resistance measurement up to 20MΩ • Continuity checker with audible tone • Diode and logic tester • Auto/manual range and data hold functions • All range protection and function indications

DMM905.....\$49.95

### A.R.T. EPROM Programmer



- Programs all current EPROMs in the 2716 to 27512 range plus the X2864 EEPROM
- RS232 port • Software included

EPP.....\$199.95

### UVP EPROM Eraser



- Erases all EPROM's • Erases 1 chip in 15 minutes and 8 chips in 21 min
- UV intensity: 6800 UW/CM<sup>2</sup>

DE4.....\$79.95

### Prototype Design Stations

- Features:
- Removable solderless breadboard
  - Variable and fixed DC power supply
  - Multi-frequency signal generator
  - Analog multimeter
  - 8 bicolor LEDs (red & green)
  - 8 logic switches
  - Logic probe
  - Lighted power switch
  - Fuse overload protected
  - Pulse Generator
  - Binary coded decimal (BCD) to 7-segment decoder/driver
  - DB25 connector
  - Frequency counter (1Hz to 1MHz)
  - Sturdy ruggedized case



WM2.....\$299.95

### Soldering and Desoldering Stations

- 60 Watt Analog Display Soldering Station • Electronic temperature control from 200° to 878°F • Cartridge heating element for a longer life of the soldering tip

XY1683.....\$69.95

- 30 Watt Electronic Temperature Controlled Desoldering Station • Electronic temperature control from 212° to 842°F • Self contained high rotary vacuum pump

XY999.....\$299.95



CIRCLE 114 ON FREE INFORMATION CARD

Quality Products

Request the 1991 Catalog



### Integrated Circuits

Part No.	1-9	10+	Part No.	1-9	10+
'4LS00	.25	.15	74LS154	1.29	1.19
'4LS02	.25	.15	74LS155	.49	.39
'4LS03	.25	.15	74LS156	.49	.39
'4LS04	.25	.15	74LS157	.45	.35
'4LS05	.28	.18	74LS158	.39	.29
'4LS06	.59	.49	74LS166	.79	.69
'4LS07	.59	.49	74LS169	.99	.89
'4LS08	.28	.18	74LS173	.49	.39
'4LS10	.25	.15	74LS175	.39	.29
'4LS11	.29	.19	74LS181	1.39	1.29
'4LS13	.35	.25	74LS189	3.95	3.85
'4LS14	.49	.39	74LS190	.59	.49
'4LS20	.28	.18	74LS191	.59	.49
'4LS21	.29	.19	74LS193	.69	.59
'4LS27	.35	.25	74LS194	.69	.59
'4LS30	.28	.18	74LS221	.69	.59
'4LS32	.28	.18	74LS240	.59	.49
'4LS38	.35	.25	74LS241	.59	.49
'4LS42	.49	.39	74LS323	2.49	2.25
'4LS47	.85	.75	74LS541	1.09	.99
'4LS48	.85	.75	74LS590	5.95	5.75
'4LS112	.39	.29	74LS670	.89	.79
'4LS122	.55	.45	74LS688	2.19	1.95
'4LS123	.49	.39	81LS95	.99	.89
'4LS125	.49	.39	81LS97	.99	.89

### Miscellaneous Components

Potentiometers	
Values available (insert ohms into space marked "XX"): 500Ω, 1K, 5K, 10K, 20K, 50K, 100K, 1MEG	
43PXX <sup>3</sup> / <sub>4</sub> Watt, 15 Turn.....	.99
63PXX <sup>1</sup> / <sub>2</sub> Watt, 1 Turn.....	.89
Transistors And Diodes	
PN2222.....	.12
1N4735.....	.25
2N4401.....	.15
PN2907.....	.12
2N3904.....	.12
1N4148.....	.07
1N4004.....	.10
1N751.....	.15
2N3055.....	.69
2N2222A.....	.25
C106B1.....	.49
1N270.....	.25
Switches	
JMT123 SPDT, On-On (Toggle).....	1.25
206-8 SPST, 16-pin (DIP).....	1.09
MPC121 SPDT, On-Off-On (Toggle).....	1.19
MS102 SPST, Momentary (Push-Button).....	.39
D-Sub Connectors and Hoods	
DB25P Male, 25-pin.....	.65
DB25H Hood.....	.39
DB25S Female, 25-pin.....	.75
LEDs	
XC209R T1, (Red).....	.14
XC556R T1 <sup>3</sup> / <sub>4</sub> , (Red).....	.12
XC556G T1 <sup>3</sup> / <sub>4</sub> , (Green).....	.16
XC556Y T1 <sup>3</sup> / <sub>4</sub> , (Yellow).....	.16
IC Sockets	
Low Profile Wire Wrap (Gold) Level #2	
8LP.....	.11
8WW.....	.49
14LP.....	.12
14WW.....	.65
16LP.....	.13
16WW.....	.69
24LP.....	.19
24WW.....	1.05
28LP.....	.22
28WW.....	1.29
40LP.....	.28
40WW.....	1.79
Solder-tail Standard & Header Plug Sockets Also Available	

### Look to Jameco.....

- Wide selection of integrated circuits and components
- Quality prototype and test equipment

#### Additional items that Jameco offers:

- Hard Drives
- Motherboards
- Memory Modules:
- SIPPs
- SIMMs
- NEC V20 and NEC V30 Chips
- RAMs
- Math Coprocessors
- Computer Kits
- Integrated Circuits
- Components
- *Much, much more !*

Let us show you what we have to offer;  
call or write for the latest Jameco catalog!

### 24 Hour Order Hotline (415) 592-8097

FAX's: (415) 592-2503  
or (415) 595-2664  
Telex 176043

1355 Shoreway Road  
Belmont, CA 94002

\$50.00 Minimum Order

Data Sheets - 50c each

For a FREE 90-Page catalog send \$2.00 to cover  
first Class Postage and Handling  
© 1990 Jameco Electronics 12 90

#### CA Residents Add

6.25%, 6.75% or 7.25% Sales Tax  
Shipping - Add 5% plus \$1.50 Insurance  
(May vary according to weight and shipping method)  
Terms: Prices subject to change without notice.  
Items subject to availability and prior sale.  
Complete list of terms/warranties is available upon request  
IBM is a registered trademark of International Business Machines



Please refer to  
Mail Key 2  
when ordering

### Assemble Your own Computer Kit!

#### Jameco 16MHz 80386SX Desktop Computer Kit

- Building your own computer provides you with a better understanding of components and their functions
- In-depth assembly instructions included
- Have your new computer assembled and running in three hours, using common tools
- Software included
- Purchase computer kits configured by Jameco or design your own

#### Jameco 16MHz 80386SX Desktop Computer Kit

##### Includes:

- 80386SX Motherboard with 2MB RAM (expandable to 8MB)
- 101-key enhanced keyboard
- Multi I/O Card
- Toshiba 1.44MB, 3.5" DSHD floppy disk drive
- Baby sized desktop case
- 200 Watt power supply
- DR DOS (Version 5.0) by Digital Research and Diagnostics QAPLUS diagnostic software

**\$1199.95**  
JE3816 monitor extra



#### Hard Drives



#### Conner (16-bit IDE)

CP3044 40MB 3.5" Low Profile.....	\$469.95
CP3184 80MB 3.5"HH.....	\$699.95
CP3104 100MB 3.5"HH.....	\$799.95
ADP20 Host Adapter.....	\$29.95

#### Relisys 14" VGA Color Monitor



- Max resolution: 720 x 480
- Bandwidth: 30MHz
- Tilt/Swivel base

RE9513.....\$449.95

#### Jameco 16-bit VGA Card



- Supports VGA, EGA, CGA, MDA and Hercules modes • Comes with 256KB video RAM upgradable to 512KB (eight 41464-80) • Capable of 640 x 480 with 256 colors, 800 x 600 with 16 colors

VG2000.....\$149.95

CIRCLE 114 ON FREE INFORMATION CARD

(415) 592-8097



# AMAZING SCIENTIFIC & ELECTRONIC PRODUCTS

**PARTS ARE IN STOCK**

GRA1 — ANTI GRAVITY GENERATOR .....	\$10.00
LC7 — 40 WATT BURNING CUTTING LASER .....	\$20.00
RUB4 — HI POWER PULSED DRILLING LASER .....	\$20.00
BTC5 — 1 MILLION VOLT TESLA COIL .....	\$20.00
MCP1 — HI VELOCITY COIL GUN .....	\$15.00
LLS1 — LASER LIGHT SHOW 3 METHODS .....	\$20.00
EH1 — ELECTRONIC HYPNOTISM TECHNIQUES .....	\$8.00
EML1 — LOWER POWERED COIL GUN LAUNCHER .....	\$8.00
JL3 — JACOB LADDER 3 MODELS .....	\$10.00
SD5 — SEE IN THE DARK .....	\$10.00
LEV1 — LEVITATION DEVICE .....	\$10.00

**ASSISTANCE AVAILABLE**

FVM1K — 3 MILE FM VOICE TRANSMITTER .....	\$34.50
PFS1K — HAND CONTROLLED PLASMA FIRE SABER .....	\$49.50
NIG7K — HI FLUX NEGATIVE ION GENERATOR .....	\$34.50
PG5K — PLASMA LIGHTNING GLOBE .....	\$49.50
LHC2K — VISIBLE SIMULATED 3 COLOR LASER .....	\$44.50
HOD1K — HOMING/TRACKING BEEPER TRANSMITTER .....	\$44.50
LGU6K — 2.5 MW HAND-HELD VISIBLE LASER GUN .....	\$249.50
BTC3K — 250,000 VOLT TABLE TOP TESLA COIL .....	\$249.50
IOG2K — ION RAY GUN, project energy without wires .....	\$129.95
TKE1K — TELEKINETIC ENHANCER/ELECTRIC MAN .....	\$79.50
WVPM7K — 3 MILE AUTO TELEPHONE TRANSMITTER .....	\$49.50

**ASSEMBLED IN OUR LABS**

LIST10 — INFINITY XMTR Listen in via phone lines .....	\$199.50
IPG70 — INVISIBLE PAIN FIELD BLAST WAVE GENERATOR .....	\$74.50
ITM10 — 100,000 VOLT INTIMIDATOR UP TO 20' .....	\$99.50
JAT30 — AUTOMATIC TELEPHONE RECORDING DEVICE .....	\$24.50
PSP40 — PHASOR SONIC BLAST WAVE PISTOL .....	\$89.50
DNE10 — ALL NEW 26" VIVID COLORED NEON STICK .....	\$74.50
LGU20 — 5 TO 1MW VISIBLE RED HeNe LASER GUN .....	\$199.50
BLS10 — 100,000 WATT BLASTER DEFENSE WAND .....	\$89.50

**EASY ORDERING PROCEDURE** - TOLL FREE 1-800-221-1705 or 24 HRS ON 1-603-673-4730 or FAX IT TO 1-603-672-5406  
VISA, MC, CHECK, MO IN US FUNDS. INCLUDE 10% SHIPPING. ORDERS \$100.00 & UP ONLY ADD \$10.00. CATALOG \$1.00 OR FREE WITH ORDER.

**INFORMATION UNLIMITED**  
P.O. BOX 716, DEPT. R2, AMHERST, NH 03031

## COMPUTERS FOR LESS

JCI 10 MHz 8088 System ..... \$ 399.00

- 10 MHz Motherboard w/ 640KB RAM
- Math Co-Processor Socket
- One 5.25" 360 KB Floppy & Controller
- 101-Key Enhanced Keyboard
- 150 Watt Power Supply & Case
- MonoGraphics Card w/ Parallel Port
- 12" Amber Monochrome Monitor

JCI Standard Configuration:

- 1 MB RAM on board 0 Wait State
- Built-In Real Time Clock & Calendar
- Math Co-Processor Socket
- One 1.2 MB or 1.44 MB Floppy Drive
- 1:1 Hard / Floppy Disk Controller
- 2 Serial, 1 Parallel, and 1 Game Port
- 101-Key Enhanced Keyboard
- Deluxe Case w/ 200 Watt Power Supply
- MonoGraphics Card w/ Parallel Port
- 12" Amber Monochrome Monitor

JCI 12 MHz 80286 System ..... \$ 649.00

JCI 16 MHz 386SX System ..... \$ 869.00

JCI 20 MHz 80386 System ..... \$ 1149.00

JCI 25 MHz 386 32K Cache ..... \$ 1495.00

JCI 33 MHz 386 32K Cache ..... \$ 1850.00

Please Call For Custom Configurations

One Year Parts & Labor Warranty  
30 Day Satisfaction Guarantee  
Shipping & Handling Extra  
VISA & M/C add 3% Amex add 4%

**JINCO COMPUTERS INC.**

5122 Walnut Grove Avenue  
San Gabriel, CA 91776

Tel: (818) 309-1108 - Fax: (818) 309-1107

## ADVERTISING INDEX

RADIO-ELECTRONICS does not assume any responsibility for errors that may appear in the index below.

Free Information Number	Page		
108	AMC Sales .....	89	78 Radio Shack .....
75	Ace Products .....	62	190,191 SCO Electronics .....
107	All Electronics .....	97	194 Sencore .....
193	Alpha Products .....	75	— Star Circuits .....
—	Amazing Concepts .....	100	192 TECI .....
77	B&K Precision .....	CV4	123,180 Test Probes .....
67	Banner Technical Books .....	90	225-228 Test Probes .....
98	Beckman Industrial .....	14	195 Unicorn .....
109	C&S Sales .....	5	181 Viejo Publications .....
70	CEI .....	94	182 WPT Publications .....
—	CIE .....	11,25	183 Xandi Electronics .....
187	Chenesko Products .....	62	
—	Command Productions .....	89	
176	Communications Specialists .....	79	
184	CompuServe .....	CV3	
55	Contact East .....	28	
58	Cook's Institute .....	81	
188	D&D Electronics .....	77	
—	Damark International .....	17	
196	Datak Corporation .....	28	
127	Deco Industries .....	62	
198	EKI .....	37	
177	Electronic Goldmine .....	94	
—	Electronics & Engineers B.C. ....	82	
121	Fluke Manufacturing .....	CV2	
189	Global Specialties .....	12	
—	Grantham College .....	56	
86	Heathkit .....	29	
185	How to Book Club .....	7	
—	ISCET .....	81	
114	Jameco .....	98,99	
104	Jan Crystals .....	89	
178	Jinco Computers .....	100	
—	King Wholesale .....	92	
—	Lindsay Publications .....	73	
53	MD Electronics .....	92	
93	Mark V. Electronics .....	93	
61	Microprocessors Unltd. ....	87	
—	NRI Schools .....	18	
186	Optoelectronics .....	39	
56	Parts Express .....	95	
197	Photronics, Inc. ....	62	
179	Probemaster .....	31	

### ADVERTISING SALES OFFICE

**Gernsback Publications, Inc.**  
500-B Bi-County Blvd.  
Farmingdale, NY 11735  
1-(516) 293-3000  
President: Larry Steckler  
Vice President: Cathy Steckler

**For Advertising ONLY**  
516-293-3000  
Fax 1-516-293-3115  
Larry Steckler  
publisher

**Arline Fishman**  
advertising director  
**Denise Haven**  
advertising assistant  
**Christina Estrada**  
advertising associate  
**Kelly McQuade**  
credit manager

**Subscriber Customer Service**

1-800-288-0652

**Order Entry for New Subscribers**

1-800-999-7139

7:00 AM - 6:00 PM M-F MST

### SALES OFFICES

#### EAST/SOUTHEAST

**Stanley Levitan**, Eastern Sales Manager  
Radio-Electronics  
259-23 57th Avenue  
Little Neck, NY 11362  
1-718-428-6037, 1-516-293-3000  
Fax 1-718-225-8594

#### MIDWEST/Texas/Arkansas/Okla.

**Ralph Bergen**, Midwest Sales Manager  
Radio-Electronics  
540 Frontage Road—Suite 339  
Northfield, IL 60093  
1-708-446-1444  
Fax 1-708-446-8451

#### PACIFIC COAST/ Mountain States

**Marvin Green**, Pacific Sales Manager  
Radio-Electronics  
5430 Van Nuys Blvd. Suite 316  
Van Nuys, CA 91401  
1-818-986-2001  
Fax 1-818-986-2009



# There's nothing new about having everything you need in one place.

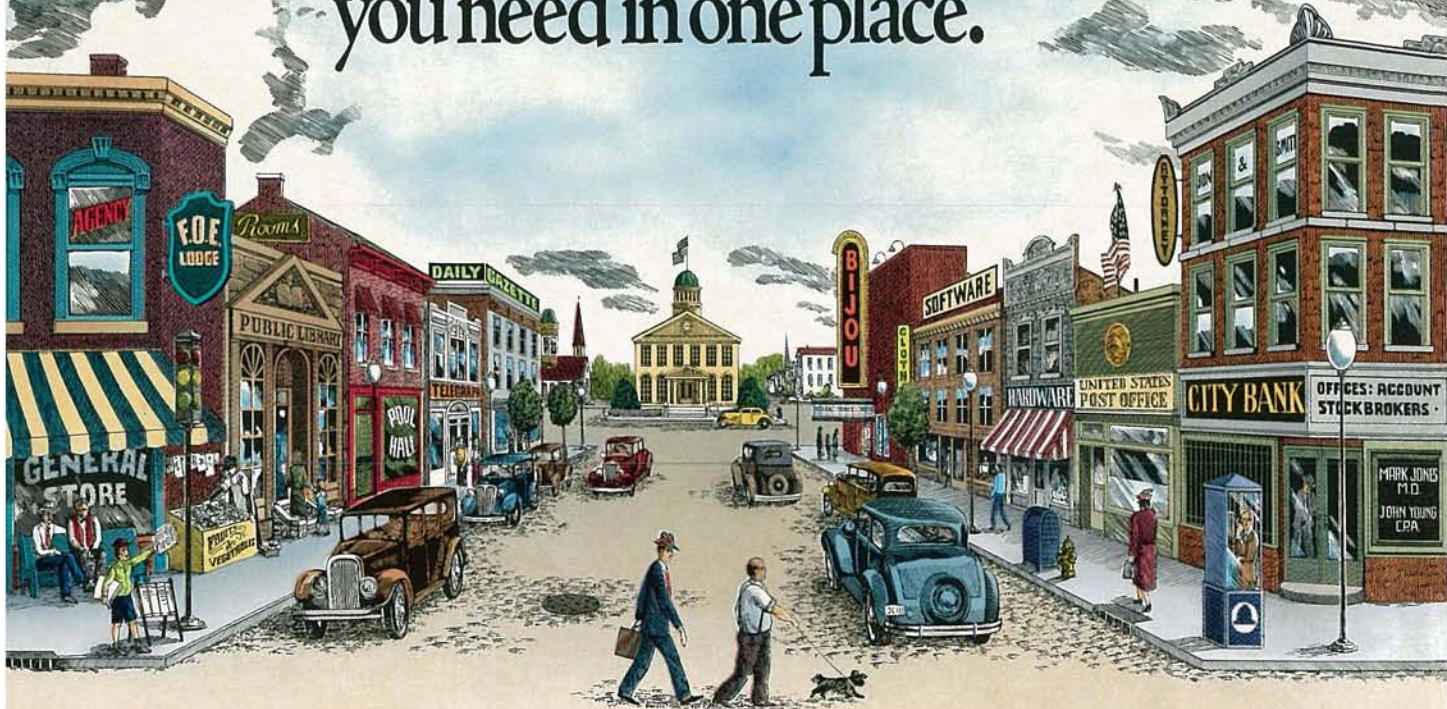

## With CompuServe, it's all at your fingertips.

When you become a member of CompuServe, you join a vital, active community of over 500,000 friends and neighbors from all over the world.

**Small-town friendly.** We keep in touch with electronic mail and faxes, and by posting messages on our bulletin boards. We even meet in forums to discuss everything from science fiction to sharing software, and to get invaluable personal computer software and hardware support. And that's one of the best things about small towns: people helping people.

**Big-city opportunities.** But we can also shop coast-to-coast at hundreds of nationally known stores, and take advantage of a world-class library. We have



access to the latest national and international news. And our special financial files offer complete statistics on over 10,000 NYSE,

AMEX, and OTC securities.

We can even trade online with our local discount brokers.

**And, just for fun . . .** We've also got games — everything from trivia to TV-style game shows with

live entertainment to interactive space and fantasy adventures.

We've got airline schedules, so you can check out the bargains and book your own flights online. We even have listings from over 35,000 hotels.

**It's not hard to get here.** To get to CompuServe, all you need is a computer and a modem. We'll send you everything else, including a \$25.00 Usage Credit. In most places you'll be able to go online with a local phone call.

To buy a CompuServe Membership Kit, see your nearest computer dealer. To receive our informative brochure or to order direct, call 800 848-8199.

**CompuServe**

CIRCLE 184 ON FREE INFORMATION CARD



# Notice any difference between these two DC power sources?

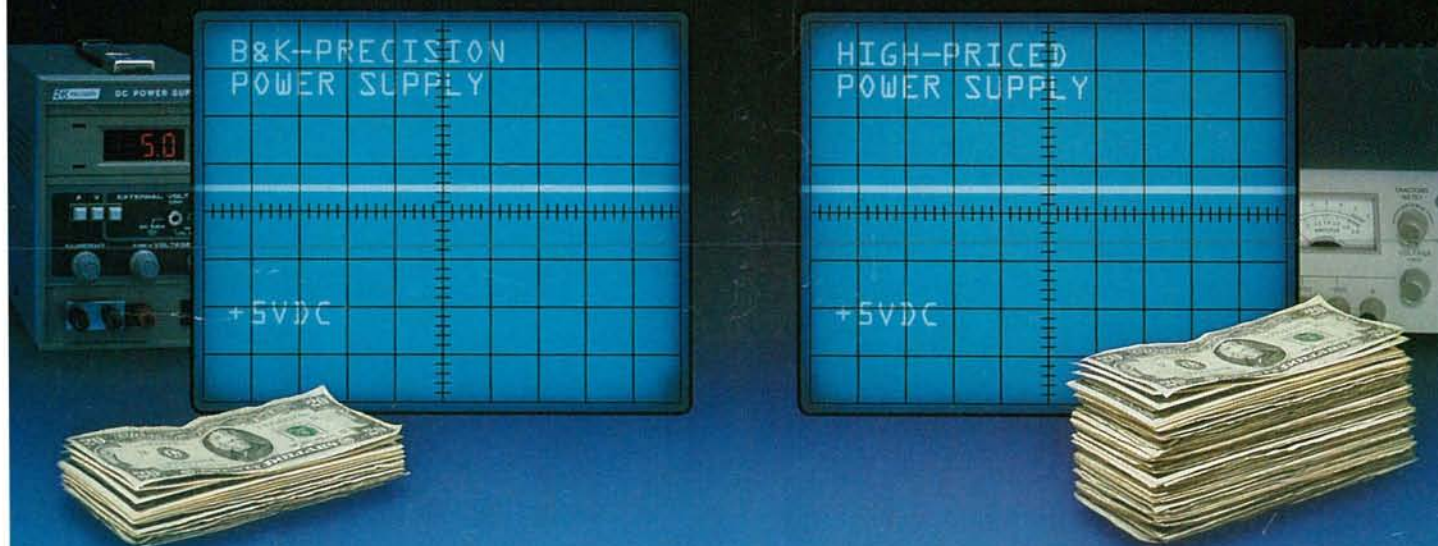

## Your budget sure will!

**B&K-PRECISION power supplies cost less** than other power supplies you may be used to buying, but to your circuits they look identical. Your circuit will see only the same pure, clean DC power that comes from the high-priced lines. You'll see the savings.

B&K-PRECISION builds DC power supplies for most bench applications requiring up to 10 amps. All are fully regulated with excellent ripple and noise characteristics. Some models feature digital metering, multiple outputs, tracking and constant current operation.

Start saving cash on your next power supply purchase. Compare features, performance and price and you'll choose B&K-PRECISION. For a free Power Supply Selection Guide or immediate delivery, contact your local distributor or B&K-PRECISION.



Front row left to right: Model 1660 \$629, Model 1610 \$215, Model 1630 \$315, Model 1635 \$365. Back row top: Model 1601 \$485, Model 1646 \$489; Bottom: Model 1650 \$510.



**BK PRECISION**  
MAXTEC INTERNATIONAL CORP.

Domestic and International Sales  
6470 W. Cortland St., Chicago, IL 60635  
312-889-1448 • FAX: 312-794-9740  
Canadian Sales, Atlas Electronics, Ontario

CIRCLE 77 ON FREE INFORMATION CARD